

Promotion *for life.*

Main catalogue 2022

EN

elasto 

PROMOTION FOR LIFE



Icons.

Product Details.



bio-based



material



dimension



packaging unit, packaging



warning notices
Details on page 347

Quality.



Made in Germany



Made in Europe

Legal notice.

Our catalogue is only intended for buyers who wish to use the goods and services exclusively within the scope of their independent professional, commercial, official or business activities and not for private individuals. All information on goods and services is non-binding and does not constitute a legally binding contractual offer, but only a so-called „invitatio ad offerendum“ (an invitation to submit an offer). **All prices stated in the catalogue are non-binding guide prices in EUR (as at the back of the catalogue); in addition, if applicable, there are costs for finishing and other ancillary costs such as packaging, shipping and transport costs, customs duties etc., as well as (if applicable) the statutory value added tax.** The product illustrations are not binding. We will be pleased to send you a sample for a precise assessment of the guaranteed properties and functions as well as the colour accuracy of a product. This sample is binding for placing an order. In the case of articles with advertising imprint, we will be pleased to provide you with a proof sample for binding approval of the print, the printing stand and

the product characteristics. All articles with customer imprint shown in this catalogue are only for the performance presentation of the printing technology and for reference purposes. The rights to the illustrated logos and brand names as well as to the illustrated custom-made products belong exclusively to the respective copyright/brand owners. Please note that in the case of set items which are marked „Made in Germany“ or „Made in Europe“, it is possible that not all individual components of the set are manufactured in Germany or Europe. However, it goes without saying that the main manufacturing or processing steps for sets marked accordingly are carried out in Germany or Europe (depending on the marking). Only the laws of the Federal Republic of Germany apply to the contractual relationship. The UN Convention on the International Sale of Goods (CISG) and the referral provisions of German international private law (IPR) shall not apply. Errors and misprints reserved.

Content.

Introduction	006
Food and Beverage	011
Home and Living	125
Office and School	145
Lifestyle and Accessories	169
Wellness and Healthcare	193
Sports, Leisure and Events	219
Camping and Outdoor	241
Toys and Games	255
Travel and Safety	275
Bags	299
Textiles	323
Index and General Information	334

We make the world more colourful.

We produce the item to your wishes choosing from a variety of standard colours or special requirements (colour sample or Pantone). Be it translucent, opaque, daylight colours, with glitter or metallic effect. There are no limits to your colour request. All our colours correspond to the applicable regulations and directives in Germany and the EU. Address the realization of your ideas to us with confidence.



320C

teal.

347C

green.

7468C

ocean.

376C

grassgreen.

286U

blue.

380C

lemon.

520U

bramble.

1235U

yellow.

215C
berry.



1665C
orange.



205U
bubblegum.



200C
red.



806C
pink.



732C
mokka.



7562U
lilac.



These are non-binding and only approximate colour indications.

We are certified: **Climate-Neutral Company!**

We not only produce on a climate-neutral basis, but have been officially certified as a **climate-neutral company** by the *German Institute for Sustainability and Ecology* since 2021.

As the first company in the advertising media sector, we not only produce climate-neutral, but have been officially certified as a climate-neutral company at the Sulzbach-Rosenberg site since 2021 by the German Institute for Sustainability and Ecology.

What does climate-neutral mean?

Companies, products and services are climate-neutral if they offset the emissions they generate to 100% according to the individual CO2 balance sheet.

The family business achieves 60% of this neutrality by saving CO2 emissions, which are achieved by its own measures. These include, for example, heat recovery and photovoltaic systems, the use of recyclable materials, 11 electric vehicles in the company's fleet, the exclusive use of recycled paper and cardboard, and efficient lighting management.

By investing in a German climate protection project, the project offsets the 40% CO2 requirement that is still necessary. This project contributes to the preservation of a forest area of 75.11 ha and thus of 45,066 trees. In addition, the forest areas offer protection to many endangered animal and plant species and thus make a valuable contribution to biodiversity.

In addition, we regularly conduct a comprehensive sustainability assessment in the fields of environment, economy and social competence according to the procedure D-20/400851, of the certifying body. The Analysis and Audit Report No. 5721 2840 documents all these activities.



Deutsches Institut für Nachhaltigkeit und Ökonomie

**Climate
neutral**

**SEAL OF
APPROVAL 2021**

Investing in the
future



Quality Made in Germany.

Production on site.

Our clear competitive advantage is **our own production** in Bavaria. Through state-of-the-art manufacturing techniques and committed and motivated employees, we are able to achieve the best quality, high efficiency, competitive prices and an exemplary environmental balance. The individual processes and sub-sections can also be monitored precisely and production sequences can be adapted.

Benefits.

- ✓ High quality standards.
- ✓ Short transport routes.
- ✓ Delivery flexibility.
- ✓ Planning security.
- ✓ Short delivery times.
- ✓ Well-thought-out functionality of the products.
- ✓ Fast and uncomplicated order processing.
- ✓ Securing jobs.
- ✓ Strengthening Germany as a location.

Food and Beverage.

- *Container*
- *Cutlery and knives*
- *Cans for snacks and provisions*
- *Cocktail accessories*
- *Dressing and spice dispenser*
- *Ice cube moulds*
- *bottle and ice cooler*
- *Bottles and carafes*
- *Bottle opener*
- *Cooking and baking accessories*
- *Mint and candy dispenser*
- *Cutting and serving boards*
- *Trays*
- *Cups, mugs and jugs*
- *Plates, bowls and dishes*
- *Drinking straws*

TRITAN YOUR LIFE

Quality Made in Germany.

Benefits.

- ✓ Made of very high quality, taste- and odourless tritan.
- ✓ Breakproof material.
- ✓ Dishwasher safe.
- ✓ BPA free and without critical plasticizers.
- ✓ The wide opening makes it easy to fill and clean.
- ✓ Leakproof.



Food and Beverage

Your Tritan Style:

Choose from over 200 combinations.

1. Volume.

0,4 / 0,5 / 0,7 / 1,0 LITER

NEW

Drink bottle „Carve“
with recessed grips



2. Bottle colours.

Solid colour



Transparent



3. Choice of lids.



REFRESH
Plastic.



SCHOOL
Plastic.



SPORTS
Plastic.



NATURAL
Bamboo.



PURE
Stainless steel.

4. Finishing tip.

Dishwasher-safe all-round
printing using the PremioTouch
process in photorealistic quality
with haptic effect.



5. Accessories.

STRAP for an easy transport.





09952 Water bottle „Acqua“ tritan

Crystal clear and lightweight bottle made from Tritan with screwable cap and special rubber plug for serving. Capacity: 0.58 litres.

Piece(s)	1	100	500	1000
EUR	5.08	4.99	4.58	4.27

Plastic/Tritan
230 mm x Ø 67 mm

48 Unit, Polybag



09978 Water bottle „Guard“ 0.5 l

Rubber bottom. Screw tight light with silicon ring. Capacity: 0.5 litres.

Piece(s)	1	100	500	1000
EUR	2.85	2.55	2.15	2.00

Plastic/Tritan
215 mm x Ø 65 mm

60 Unit, Polybag



08705 Water bottle „Denver“ Tritan

Large, light, stable and tight. Bottle made of Tritan in slightly conical shape with firmly screwable lid and a finish in chrome look. The sealing rubber makes sure that even carbonated beverages will not leak. Capacity: 0.82 litres.

Piece(s)	1	100	500	1000
EUR	5.31	4.75	4.00	3.73

Plastic/Tritan
250 mm x Ø 80 mm

48 Unit, Polybag



09493 Fruit Infuser Bottle „Frutto“ 0,5 l, tritan

Just for the slight thirst. Drinking bottle made of transparent Tritan with leak-proof snap lock and screwable cap. The special feature is the filter element inside the bottle. It can be filled with fruits and the bottle can be filled with fresh water. The fruits release their flavor through the filter slots, adding that special fruity taste to your water. Capacity: 0,5 l.

Piece(s)	1	100	500	1000
EUR	5.11	4.58	3.86	3.60

Plastic/Tritan
230 mm x Ø 68 mm

48 Unit, Polybag



09954 Fruit Infuser Bottle „Frutto“ 0,8 l, tritan

Piece(s)	1	100	500	1000
EUR	5.13	4.85	4.48	4.18

Plastic/Tritan
280 mm x Ø 75 mm

48 Unit, Polybag

NEW!

01789 Drink bottle „Cascada“, 0.67 l

A bottle in a minimalist design - perfect for work, yoga, hiking, travelling, etc. This lightweight flask is made from Tritan and has a screw cap. This features a silicone seal, a carry handle for easy transportation and a covering cap made from bamboo wood. Capacity: 0.67 litres.

Piece(s)	1	100	500	1000
EUR	6.31	5.64	4.76	4.44

Plastic/Tritan 25 Unit, Polybag
 220 mm x Ø 71 mm



01790 Drink bottle „Cascada“, 0.87 l

Piece(s)	1	100	500	1000
EUR	7.03	6.29	5.30	4.94

Plastic/Tritan 25 Unit, Polybag
 264 mm x Ø 73 mm



08953 Water bottle „Atlanta“

The crystal clear bottle made from SAN plastic with screwable cap made from stainless steel with rubber insert for high tightness. Capacity: 0.6 litres.

Piece(s)	1	100	500	1000
EUR	4.87	4.36	3.67	3.43

Plastic/SAN 30 Unit, Individual carton + Polybag
 210 mm x Ø 75 mm



08927 Water bottle „Austin“

The perfect mix of plastic and stainless steel. Ergonomically shaped bottle made from PS plastic with stand and screw cap made from stainless steel. The polyester strap which is attached to the cap ensures that the cap remains attached to the bottle and also allows the bottle to be attached to a backpack or the like. Capacity: 0.6 litres.

Piece(s)	1	100	500	1000
EUR	3.83	3.55	3.17	2.96

Plastic/Polystyrene 40 Unit, Individual carton + Polybag
 223 mm x Ø 73 mm



SALE!

08930 Water bottle „Portland“

Really sporty. Handy bottle made from plastic featuring a screwable lid with integrated handle and foldable drinking nozzle. Capacity: 0.5 litres.

Piece(s)	1	100	500	1000
EUR	2.85	2.70	2.42	2.27

Plastic/SAN

40 Unit, Polybag

210 mm x Ø 73 mm



SALE!

09073 Water bottle „3in1“

Bottle, fitness towel and smartphone holder in one item. Water bottle with robust plastic snap hook at the bottle neck for easy fixture to rucksacks and sport bags. The unscrewable base of the bottle contains a fitness towel with cooling (cf. item no. 08932). The base floor can be extracted and used as a safe smartphone holder even without the bottle being attached. Capacity of the bottle: 0.55 litres. Size of towel: 80 x 20 cm

Piece(s)	1	100	500	1000
EUR	3.99	3.79	3.65	3.56

Plastic/Polyethylene

36 Unit, Polybag

275 mm x 100 mm x 70 mm



SALE!

08928 Water bottle „Squeeze“

Lightweight, space-saving, efficient. This innovative drinking bottle consists of a flexible silicone body, a screwable plastic lid with sealable drinking nozzle and an attached snap hook. The special highlight: The bottle can be rolled up and fixed using the attached silicon strap even when filled. In this way, the bottle requires less baggage space. Completely demountable for an optimum cleaning. Capacity: 0.7 litres.

Piece(s)	1	50	250	500
EUR	5.85	5.71	5.56	5.42

Plastic/Silicone

30 Unit, Polybag

210 mm x Ø 74 mm



05085 Drinking bottle „Power Bottle“

Bottle in the shape of dumb bells with cap. Easy to hold, even for children. Capacity: 1.0 litres.

Piece(s)	1	100	500	1000
EUR	3.49	3.12	2.63	2.46

Plastic/Polyethylene

40 Unit, Bulk

290 mm x Ø 87 mm



05076 Water bottle „Bicycle“ 0.5 l with drinking nipple

Made of food-safe plastic with drinking nipple and easy-grip structure. Capacity: 0.5 litres. Other colours on request.

Piece(s)	1	500	1000	5000
EUR	2.07	1.86	1.56	1.46

Plastic/Polyethylene
 197 mm x Ø 78 mm

50 Unit, Bulk

05078 Water bottle „Bicycle“ 0.7 l with drinking nipple

Piece(s)	1	100	500	1000
EUR	2.49	2.23	1.88	1.75

Plastic/Polyethylene
 253 mm x Ø 80 mm

40 Unit, Bulk



05075 Water bottle „Bicycle“ 0.5 l with cap

Made of food-safe plastic with cap and easy-grip structure. Capacity: 0.5 litres. Other colours on request.

Piece(s)	1	500	1000	5000
EUR	2.21	1.98	1.67	1.55

Plastic/Polyethylene
 178 mm x Ø 78 mm

50 Unit, Bulk

05079 Water bottle „Bicycle“ 0.7 l with cap

Piece(s)	1	100	500	1000
EUR	2.39	2.14	1.80	1.68

Plastic/Polyethylene
 250 mm x Ø 80 mm

40 Unit, Bulk



05059 Drinking bottle „Champion“ 0.55 l

Custom produced blow-moulded bottle. Practical click stopper with tightly sealing lid. Capacity: 0.55 litres.

Piece(s)	1	100	500	1000
EUR	3.50	3.13	2.64	2.46

Plastic/Polypropylene
184 mm x Ø 75 mm

60 Unit, Bulk

05105 Water bottle „Champion“ 0.7 l

Piece(s)	1	100	500	1000
EUR	4.02	3.60	3.03	2.83

Plastic/Polypropylene
210 mm x Ø 75 mm

45 Unit, Bulk



05129 Water bottle „Fitness“ 0.5 l with suction lock

The small sporty look plastic Bottle with practical grip groove and screw cap with suction lock. Ideal for single-handed use. Cover is completely removable and thus easier to clean. Weight: 0.5 litres.

Piece(s)	1	100	500	1000
EUR	2.85	2.55	2.15	2.01

Plastic/Polypropylene
175 mm x Ø 74 mm

50 Unit, Bulk

05131 Water bottle „Fitness“ 0.7 l with suction lock

Piece(s)	1	100	500	1000
EUR	3.09	2.76	2.33	2.17

Plastic/Polypropylene
235 mm x Ø 74 mm

45 Unit, Bulk

Quality Made in Germany.

DRINK BOTTLE made from (r)PET.

1



PET bottles are manufactured and placed onto the market.

2



After use the PET bottles are disposed of at collection points.

3



The bottles are collected, sorted and then cleaned.

4



They are then broken down into flakes and cleaned again.

5

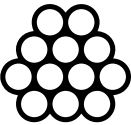

The flakes are further processed into plastic granulate.

6



From the granules, a new product is created from recycled PET.



Recycled PET?

NEW!

**01785 Drink bottle
„Sports“ grey-
transparent 0.4 l, RPET**

500 pcs. from **2.49€**



Or classic PET?

NEW!

**01848 Drink bottle
Colare „Refresh“ clear-
transparent, 1.0 l**

500 pcs. from **3.00€**





Benefits.

- ✓ Made from very high-quality, taste- and odourless PET or rPET.
- ✓ BPA free and without critical plasticizers.
- ✓ The wide opening makes it easy to fill and clean.
- ✓ Leakproof.
- ✓ Climate-neutral production in Germany.

01025 Glass bottle „Life“ 0,55 l

Elegant glass bottle made of sturdy borosilicate glass with screw lid and silicone seal. The grey synthetic rubber cover with strap keeps the temperature of the drinks constantly longer. Moreover it protects the hands if hot drinks are inside the glass. Capacity: 0.55 litre.

Piece(s)	1	100	500	1000
EUR	9.11	8.16	6.87	6.41



 Glass/Borosilicate
 243 mm x Ø 63 mm

 24 Unit, Individual carton + Polybag



01026 Glass bottle „Life“ 0,7 l

Piece(s)	1	50	250	500
EUR	9.63	8.62	7.26	6.77



 Glass/Borosilicate
 275 mm x Ø 70 mm

 12 Unit, Individual carton

01028 Glass bottle „Flavour“ 0,5 l

For tasteful drinks. Elegant glass bottle made of Borosilikat with screw lid made of stainless steel incl. silicone seal. The grey synthetic rubber cover with strap keeps the temperature of the drinks constant longer. Moreover it protects the hands if hot drinks are inside the glass. The sieve for tea or fruit at the bottom is securely connected to the bottle by a screw cap. Capacity: 0.5 litre.

Piece(s)	1	50	250	500
EUR	10.35	9.26	7.80	7.28

 Glass/Borosilicate
 252 mm x Ø 65 mm

 24 Unit, Individual carton

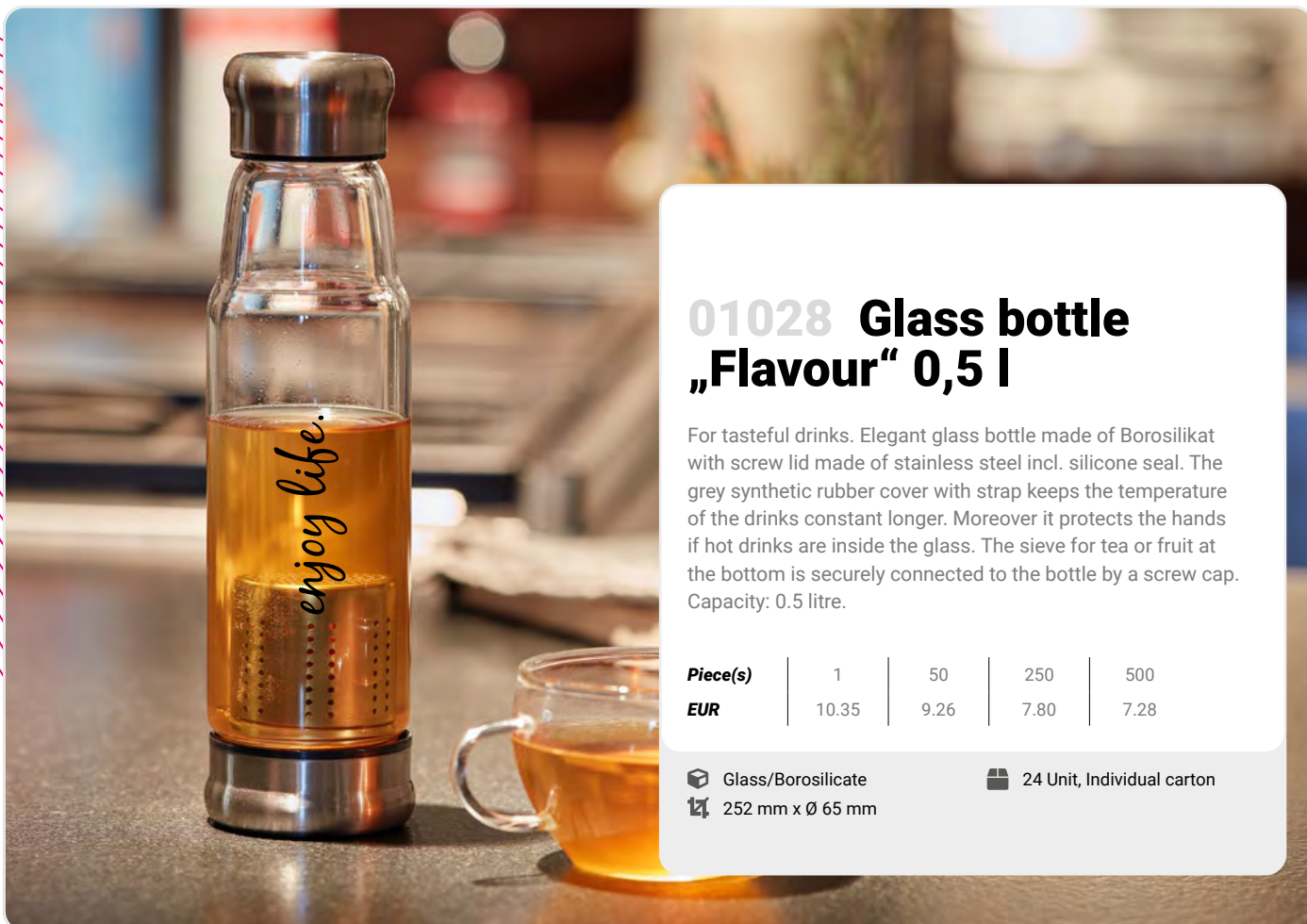



NEW!

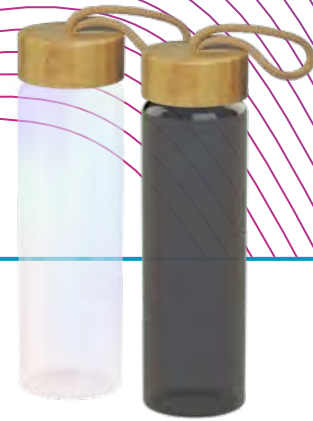

01791 Glass bottle „Bamboo“, 0.65 l, colour

The ideal glass flask for home and on the go. The body of the flask is made from high-quality borosilicate glass. The flask closes with an elegant bamboo lid with a holding strap. Colours: grey transparent & transparent with rainbow effect. Capacity: 0.65 litres.

Piece(s)	1	50	250	500
EUR	11.66	10.44	8.80	8.21

Glass/Borosilicate
 240 mm x Ø 65 mm

25 Unit, Individual carton + Polybag

01232 Glass bottle with sleeve „Bamboo“ 0,55 l

Bottle made from borosilicate glass with screw top made from bamboo incl. silicone seal. The handy, grey synthetic rubber case with carry strap keeps the temperature of the drink stable for longer. It also protects your hands against the warm glass when containing hot drinks. Capacity: 0.55 litre.

Piece(s)	1	50	250	500
EUR	12.02	10.76	9.07	8.46

Glass/Borosilicate
 230 mm x Ø 65 mm

24 Unit, Individual carton



01027 Glass bottle „Bamboo“ 1,0 l

Piece(s)	1	50	250	500
EUR	14.79	13.24	11.15	10.40

01027
 280 mm x Ø 80 mm
 12 Unit, Individual carton

01521 Glass bottle with sleeve „Bamboo“ 0,75 l

Piece(s)	1	50	250	500
EUR	11.94	10.69	9.01	8.40

01521
 275 mm x Ø 65 mm
 12 Unit, Individual carton + Polybag



01562 Glass bottle „Frosted“, 0.55 l



Bottle with a special effect. This bottle made from high-quality borosilicate glass has a discreet, matt colour gradient, which makes it really eye-catching. The screw-top lid made from bamboo gives the bottle a natural look. Capacity: 0.55 litre.

Piece(s)	1	50	250	500
EUR	9.72	8.70	7.33	6.84





01563 Glass bottle „Frosted“, 0.7 l

Piece(s)	1	50	250	500
EUR	10.53	9.43	7.94	7.41

 Glass/Borosilicate
 195 mm x Ø 65 mm

 25 Unit, Individual carton +
 Bubble wrap

 Glass/Borosilicate
 240 mm x Ø 65 mm



 25 Unit, Individual carton +
 Bubble wrap



01369 Glass bottle with case „Iced“, 0.5 l

Really striking! This bottle made from soda-lime glass has a discreet, matt colour gradient which transitions from dark grey to light grey. It closes with a screw-fastening metal lid. The colour-coordinated grey synthetic rubber case ensures drinks stay at the desired temperature for longer. Capacity: 0.5 litre.

Piece(s)	1	100	500	1000
EUR	3.69	3.30	2.78	2.59



 Glass/Soda Lime
 220 mm x Ø 70 mm

 35 Unit, Individual carton



01371 Glass bottle with case „Iced“, 1.0 l

Piece(s)	1	100	500	1000
EUR	4.50	4.03	3.39	3.17

 Glass/Soda Lime
 250 mm x Ø 85 mm



 24 Unit, Individual carton



01233 Glass bottle with sleeve „Ocean“ 0,36 l

Compact glass bottle made from borosilicate glass with screw top made from stainless steel incl. silicone seal. The handy, grey synthetic rubber case with carry strap keeps the temperature of the drink stable for longer. It also protects your hands against the warm glass when containing hot drinks. Capacity: 0.36 litre.

Piece(s)	1	100	500	1000
EUR	6.85	6.13	5.17	4.82

 Glass/Borosilicate
 200 mm x Ø 65 mm

 24 Unit, Individual carton + Polybag





NEW!

01792 Glass bottle „Colare“, 0.60 l

The ideal glass flask for home and on the go. The body of the flask is made from soda lime glass. The silicon ring inside the metal screw cap makes the flask leak-proof. Capacity: 0.6 litres.

Piece(s)	1	100	500	1000
EUR	3.27	2.92	2.46	2.30

 Glass/Soda Lime
 253 mm x Ø 72 mm

 25 Unit, Polybag





01029 Glass carafe „Fresh“ 1,0 l

Elegant glass carafe made of sodalime glass with plastic spout, which is securely connected to the carafe by a screw cap. Capacity: 1.0 litre.

Piece(s)	1	50	250	500
EUR	8.94	8.57	7.90	7.37

Glass/Soda Lime
 285 mm x Ø 96 mm

12 Unit, Individual carton + Polybag



01375 Glass carafe „Minerale“, 0.85 l

Glass carafe made from soda-lime glass with a screw-top lid. This is made from black PP and has a spout. Capacity: approx. 0,85 litre.

Piece(s)	1	100	500	1000
EUR	3.80	3.40	2.87	2.67

Glass/Soda Lime
 260 mm x Ø 95 mm

20 Unit, Individual carton



01082 Glass bottle „Tea“

Beautiful glass bottle with integrated tea strainer. There is a stainless steel tea strainer attached to the inside of the borosilicate glass bottle. The bottle closes with an elegant bamboo lid with a silicone seal. It can be completely disassembled, which makes it very easy to clean. Capacity: approx. 0.45 litre.

Piece(s)	1	25	100	250
EUR	20.75	18.58	15.65	14.60

Glass/Borosilicate
 235 mm x Ø 70 mm

24 Unit, Individual carton + Polybag



01497 Teapot „Tea-Time“

The teapot, made of high-quality borosilicate glass with a plastic lid and a metal strainer, is perfect for making your favourite tea. The metal strainer made from stainless steel ensures fast and simple preparation: simply add loose tea or tea leaves, place the metal strainer into the teapot and put the plastic lid on. The plastic lid keeps the heat in throughout the tea's brewing time, for a wonderfully aromatic experience.

Piece(s)	1	50	250	500
EUR	11.76	10.88	9.72	9.07

Glass/Borosilicate + Stainless steel + PP

36 Unit, Individual carton + Bubble wrap



130 mm x Ø 12 mm



01538 Aluminium Bottle „Bamboo“, 0.6 l

A real lightweight among drinking bottles! Weighing just under 100 g, the „Bamboo“ aluminium drinking bottle is the perfect companion for every adventure. The bamboo lid and matt black top also make the bottle a real stunner in terms of design. Includes silicone strap. Capacity: 600 ml.

Piece(s)	1	100	500	1000
EUR	5.28	4.72	3.95	3.66

 Metal/Aluminium
 240 mm x Ø 60 mm

 50 Unit, Individual carton + Polybag



NEW!

01877 Aluminium bottle „Miami“

Extended drinking pleasure with the sporty and practical aluminium drinking bottle with a sealed screw closure and practical mouthpiece. Capacity: 650 ml.

Piece(s)	1	100	500	1000
EUR	8.70	7.79	6.56	6.12

 Metal/Aluminium
 265 mm x Ø 66 mm

 60 Unit, Individual carton





NEW!

01878 Drink bottle „Denali“

The high-quality drinking bottle with a catch closure in an elegant design, made of single-walled stainless steel cuts a great figure for hiking, sport and in the office. Capacity: 850 ml.

Piece(s)	1	25	100	250
EUR	17.82	15.95	13.44	12.54

 Metal/Stainless steel
 270 mm x Ø 73 mm

 20 Unit, Individual carton



09975 Aluminium bottle „Sporty“ 0.6 l

Sports bottle made of aluminium with 0.6 litres and carabiner.

Piece(s)	1	100	500	1000
EUR	4.99	4.65	4.19	3.91

Metal/Aluminium
 205 mm x Ø 70 mm

80 Unit, Individual carton + Polybag

09992 Aluminium Bottle „Sporty“ 0.6 l matte

Piece(s)	1	100	500	1000
EUR	4.75	4.39	4.02	3.75

Metal/Aluminium
 210 mm x Ø 70 mm

48 Unit, Individual carton + Polybag



08871 Aluminium Bottle „Sporty-2Tone“ gungrey 0.6 l

A bottle for outdoor fans! Aluminium sports bottle with sealed screw cap with silicone ring incl. key ring with snap hook. The haptic and striking two-colour effect, which results from refinement by laser engraving, provides for impressive and long-lived advertising success. Capacity: 0.6 litres

Piece(s)	1	100	500	1000
EUR	5.92	5.49	5.05	4.71

Metal/Aluminium
 210 mm x Ø 73 mm

48 Unit, Individual carton + Polybag

08869 Aluminium bottle „2Tone“ 0.6 l, matte

Piece(s)	1	100	500	1000
EUR	5.95	5.51	5.00	4.66

Metal/Aluminium
 210 mm x Ø 71 mm

48 Unit, Individual carton + Polybag



NEW!



01719 Filter insert for bottle „Cascada“

The stainless steel strainer is screwed onto the inside of the Cascada vacuum bottles. Perfect for preparing hot drinks such as tea, but also great for that little extra for cool drinks. For example, the mineral water can be refined with berries or herbs. Suitable for the following bottles: 01652 and 01653 in all colours. 01356 in the colours black and silver.

Piece(s)	1	100	500	1000
EUR	2.11	1.89	1.59	1.48

Metal/Stainless steel

200 Unit, Polybag

57 mm x Ø 34 mm

SALE!

01354 Vacuum flask „Cascada“, 0.35 l

Small insulated flask in a minimalist design - perfect for work, yoga, hiking, travelling and all day-to-day activities. Lightweight, double-walled, stainless steel flask with a screw-top lid. This has a silicone seal, a carry handle for easy transportation and a covering cap made from unpainted bamboo. Capacity: 0.35 litre.

Piece(s)	1	50	250	500
EUR	7.51	7.14	6.41	5.98

Metal/Stainless steel
 180 mm x Ø 70 mm

25 Unit, Individual carton + Polybag



01356 Vacuum flask „Cascada“, 0.5 l

Piece(s)	1	50	250	500
EUR	12.06	10.79	9.09	8.48

Metal/Stainless steel
 220 mm

30 Unit, Individual carton + Polybag





NEW!

01707 Vacuum flask „Colare“ 0.5 l

High-quality stainless steel vacuum flask - ideal for at home or on the go. The double-walled insulation maintains the internal temperature, regardless of the external temperature, thus keeping your beverages warm or cold for longer. The silicon ring inside the lid makes the flask leak-proof. Available in 3 different sizes. Capacity: 0.5 litres.

Piece(s)	1	50	250	500
EUR	8.28	7.71	7.06	6.58

 Metal/Stainless steel
 270 mm x Ø 70 mm

 25 Unit, Individual carton + Polybag







01709 Vacuum flask „Colare“ 1.0 l

Piece(s)	1	50	250	500
EUR	13.57	12.86	12.07	11.26

01708 Vacuum flask „Colare“ 0.75 l

Piece(s)	1	50	250	500
EUR	11.14	10.00	9.58	8.94

01709
 325 mm x Ø 90 mm
 25 Unit, Individual carton



01708
 300 mm x Ø 80 mm
 25 Unit, Individual carton + Polybag



01295 Vacuum flask „Bambus“, small

Perfect for your next cup of tea! Double-walled, insulated vacuum flask made from stainless steel with an external cover made from bamboo. The flask has a screw-top lid and is leakproof. Inside it has a removable filter, which holds back the tea when you pour it into the cup. Capacity: 0.35 litre.

Piece(s)	1	50	250	500
EUR	11.86	11.04	10.26	9.57



 Metal/Stainless steel
 205 mm x Ø 67 mm

 30 Unit, Individual carton + Polybag



01294 Vacuum flask „Bambus“, large

Piece(s)	1	50	250	500
EUR	12.36	12.00	10.95	10.22

 Metal/Stainless steel
 241 mm x Ø 70 mm

 30 Unit, Individual carton + Polybag



09885 Thermos bottle „Vakuum“ 0.5 l

Hot or cold for a long time. Good insulating properties thanks to the double walls. With integrated drinking cup and one-hand closure. Capacity: 0.5 litres.

Piece(s)	1	100	500	1000
EUR	7.35	6.58	5.54	5.17

Metal/Stainless steel
 245 mm x Ø 70 mm

20 Unit, Individual carton + Polybag

SALE!

09492 Thermos bottle „Vakuum“ 0.5 l, painted

Piece(s)	1	50	250	500
EUR	5.13	4.85	4.65	4.50

Metal/Stainless steel
 250 mm x Ø 70 mm

20 Unit, Individual carton + Polybag



SALE!

09455 Insulated Bottle „Nevada“

Keeps your drink warm or cold for at least 5 hours. Double-walled vacuum bottle with integrated drinking cup, practical one-hand closure and carrying strap. Absolutely watertight and has a very good grip due to the special coating. Capacity: 0.5 litres.

Piece(s)	1	50	250	500
EUR	10.30	9.22	7.77	7.25

Metal/Stainless steel
 245 mm x Ø 68 mm

25 Unit, Individual carton + Polybag



NEW!



01838 Sieve insert for insulated mug „Temptation“

The perfect addition to your Temptation mug. Simply put the stainless steel sieve in the mug, done! Perfect for preparing warm drinks, e.g. tea. Very suitable for adding that special touch to cool drinks. Makes ice cooled mineral water with berries or herbs really special.

Price on request

 Metal/Stainless steel



 200 Unit, Polybag



01372 Insulated mug „Temptation“, small

Small insulated mug with grey silicone sleeve. The mug is vacuum insulated, so it keeps drinks at a constant temperature for longer. With a screw-top lid made from PP and a closable drinking aperture. Capacity: approx. 0.3 litres.



Piece(s)	1	25	100	250
EUR	16.43	15.72	14.41	13.45

 Metal/Stainless steel
 128 mm x Ø 84 mm

 30 Unit, Individual carton + Polybag

01373 Insulated mug „Temptation“, large

Piece(s)	1	25	100	250
EUR	18.43	17.58	16.10	15.03

 Metal/Stainless steel
 198 mm x Ø 84 mm

 30 Unit, Individual carton + Polybag

DIAMOND TO GO.

06108

Insulated mug „Diamond“

High-quality thermo mug made of stainless steel in shimmering diamond design.

250 pcs. from **12.93€**

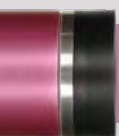

Leakproof

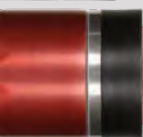

Double walled



BPA-free

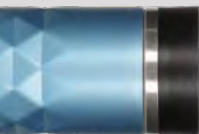

For hot and cold drinks



Easy to clean



Simple handling



Filling volume 450 ml



image source: iStockphoto.com / Deegreez



09407 Insulated bottle „Toronto“

A bottle for outdoor fans. Double-walled drinking bottle with vacuum between the individual walls for the perfect insulation of the beverages. The bottle is closed by a robust Tritan cap equipped with a stainless steel ring. Thanks to the rubber coating on the outside, the bottle is particularly handy. An EVA badge at the bottom side provides for an anti-skid effect. Capacity: 0.45 litres

Piece(s)	1	50	250	500
EUR	14.87	13.31	11.21	10.46

Metal/Stainless steel
 225 mm x Ø 68 mm

30 Unit, Individual carton + Polybag



01535 Thermo-Mug „Milano“, 0,35 l

Enjoy the taste of freshly brewed coffee/tea for hours, without burning your fingers! The double-walled, insulated mug in stainless steel is the perfect companion for all coffee and tea lovers. The cleverly curved shape of the mug, which can be opened and closed single-handedly, make it a real must-have item. Thanks to the screw-on top with silicon ring, the contents will always remain reliably inside. Capacity: 350 ml.

Piece(s)	1	50	250	500
EUR	9.84	9.12	8.34	7.79

Metal/Stainless steel + PP
 200 mm x Ø 70 mm

25 Unit, Individual carton + Polybag



09906 Insulated Mug „Allan“

For hot and cold drinks. Attractive double-walled thermal flask with a stainless steel housing. The removable lid has a sealable drinking spout and a high rim for a pleasant drinking experience. Capacity: 0.45 litres.

Piece(s)	1	100	500	1000
EUR	5.11	4.75	4.10	3.83

Metal/Stainless steel
 180 mm x Ø 80 mm

25 Unit, Individual carton + Polybag



05987 Insulating cup „Macchiato“

Cup - to Go! The cup has a closable lid. Suitable for hot and cold drinks. The anti-slip pad on the base ensures secure placement. Filling quantity: 0.4 litres.

Piece(s)	1	100	500	1000
EUR	4.35	3.89	3.27	3.06

Metal/Stainless steel
 115 mm x Ø 86 mm

24 Unit, Individual carton + Polybag



05545 Insulated mug „Coffee To Go“

Double-walled insulated mug made of plastics with screwable cap and slightly raised drinking rim. The drinking opening can be tightly closed by means of a hinged lid. Suitable for hot and cold beverages. Available in many different colours and as transparent version with insert. Made in Germany. Capacity: 0.35 litres.

Piece(s)	1	100	500	1000
EUR	5.79	5.10	4.30	4.01

Plastic/Polystyrene
190 mm x Ø 82 mm

50 Unit, Polybag



SALE!

09991 Insulated Mug „Colombia“

A coffee to go, please. Double layered stainless steel beaker with transparent outer casing and completely removable lid. The depositor can come in 4 colours and individually equipped. Capacity: 0.28 litres.

Piece(s)	1	100	500	1000
EUR	2.09	1.87	1.57	1.47

Plastic/Polypropylene
130 mm x Ø 75 mm

100 Unit, Individual carton + Polybag



05547 Insulated mug „Gusto“

Double-walled plastic mug with screw-on lid and slightly raised rim – Made in Germany. The drinking opening can be closed separately by a hinge lid. Due to the double-walled construction, the item has good insulation characteristics and is therefore suitable for hot and cold drinks. Available in many different colors as well as transparent for paper inlays. Capacity: 0.35 litres.

Piece(s)	1	100	500	1000
EUR	6.04	5.38	4.47	4.17

Plastic/Polystyrene
190 mm x Ø 82 mm

50 Unit, Polybag



06654 Insulated Mug „Melange“

Light, double walled plastic thermo cup with handle. Insert interchangeable. With small, closable drinking opening in the lid. Capacity: 0.4 litres

Piece(s)	1	100	500	1000
EUR	2.73	2.53	2.33	2.17

Plastic/Polypropylene
175 mm x Ø 90 mm



50 Unit, Individual carton + Polybag



04827 Insulated mug „Mocha“

The cup speaks for itself! Fancy, double-walled insulating cup with highly polished inner cup. Suitable for hot and cold drinks. Available in many different colour combinations and as transparent version with insert. Capacity: 0.35 litres.

Piece(s)	1	100	500	1000
EUR	7.45	6.67	5.62	5.24

 Plastic/Polystyrene
 160 mm x Ø 55 mm

 50 Unit, Polybag





NEW!

01495 Insulated cup „Mocha“ with tea strainer

By the lake, playing sport or simply enjoying a little time out: the „Mocha“ insulated cup is always with you! It holds 350 ml of hot or cold tea and has an integrated infuser, meaning that the tea can be brewed directly in the cup. Ice tea can also be flavoured with fresh herbs, berries or fruit.

Piece(s)	1	100	500	1000
EUR	7.83	7.01	5.91	5.51

 Plastic/Polystyrene
 160 mm x Ø 55 mm

 50 Unit, Polybag



01048 Coffee mug „Venice“

Double-walled stainless steel cup with removable lid. Bottom has an anti-slipping material. Capacity: 0.25 litre.

Piece(s)	1	100	500	1000
EUR	4.58	4.10	3.45	3.22

Metal/Stainless steel
 143 mm x Ø 71 mm

25 Unit, Individual carton + Polybag



01284 Coffee cup „Vienna“

Coffee cup with a diamond design. Fantastic double-walled coffee cup with an external stainless steel surface including eye-catching diamond design. Just like the inner cup, the lid with screw fastening and catch fastener is made from PP. The non-slip coating on the base ensures stability. Capacity: approx. 0.3 litres.

Piece(s)	1	100	500	1000
EUR	5.28	4.85	4.45	4.15

Metal/Stainless steel
 170 mm x Ø 70 mm

25 Unit, Individual carton + Polybag



01335 Coffee cup „Roma“

Coffee cup with a wave design. Fantastic double-walled coffee cup with an external stainless steel surface including eye-catching wave design. Just like the inner cup, the lid with screw fastening and catch fastener is made from PP. The non-slip coating on the base ensures stability. Capacity: 0.3 litres.

Piece(s)	1	100	500	1000
EUR	4.33	3.88	3.27	3.05

Metal/Stainless steel
 130 mm x Ø 78 mm

25 Unit, Individual carton



08998 Coffee mug „Medano“

It always fits. Double-Walled coffee mug that fits under any coffee machine and into any car cup holder. Made from stainless steel on the outside and from plastics on the inside, equipped with a silicone gasket inside the cap, it keeps the beverage there where it is supposed to stay. The nose at the cap guarantees easy removal from it. Capacity: 0.28 litres.

Piece(s)	1	100	500	1000
EUR	4.79	4.56	4.44	4.14

Metal/Stainless steel
 105 mm x Ø 85 mm

50 Unit, Individual carton + Polybag



01338 Coffee cup „Espresso“

Small, double-walled coffee cup that fits under the dispenser on all standard coffee machines. Stainless steel exterior with a plastic lid that clips on incl. slide locking device. Capacity: 0.15 litres.

Piece(s)	1	100	500	1000
EUR	4.83	4.32	3.64	3.40

Metal/Stainless steel
 95 mm x Ø 73 mm

50 Unit, Individual carton + Polybag



SALE!

01047 Coffee mug „Florence“

Double-walled cup with removable lid. Made of stainless steel on the outside and plastic on the inside, the integrated silicone seal in the lid keeps the drink where its supposed to be. The slider on the lid makes it easy to open. The base has an anti-slipping material. Capacity: 0.5 litres.

Piece(s)	1	100	500	1000
EUR	3.56	3.27	3.13	2.92

Metal/Stainless steel
 170 mm x Ø 88 mm

25 Unit, Individual carton + Polybag

01286 Glass coffee cup „Cristallo“, small

Elegant coffee cup made from high-quality borosilicate glass. The silicone lid can be attached and has a drinking aperture. Incl. felt sleeve so you can safely enjoy hot drinks. Capacity: 0.3 litre.

Piece(s)	1	100	500	1000
EUR	6.32	5.66	4.77	4.45

Glass/Borosilicate
 130 mm x Ø 90 mm

30 Unit, Individual carton + Polybag



01285 Glass coffee cup „Cristallo“, large

Piece(s)	1	100	500	1000
EUR	6.66	5.97	5.03	4.69

Glass/Borosilicate
 170 mm x Ø 90 mm

20 Unit, Individual carton + Polybag

COFFEE MUG

#UP CYCLING



Quality
Made in
Germany.

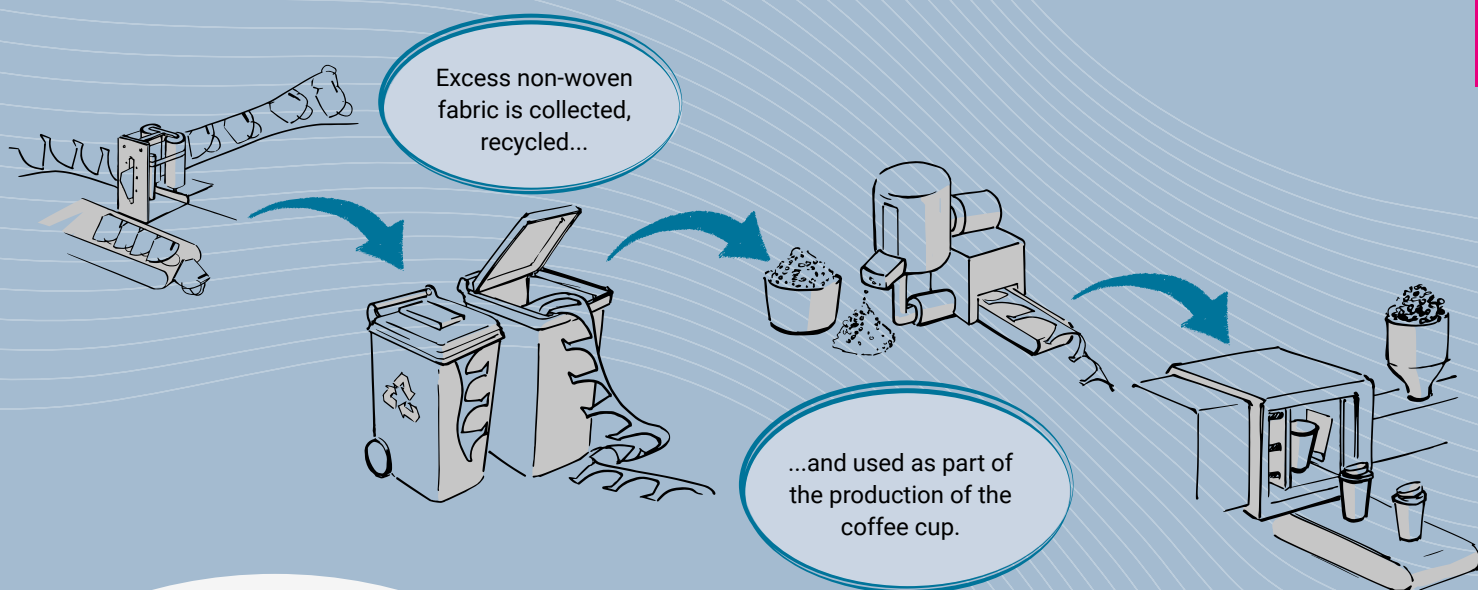

- ✓ Sustainable and reusable alternative to the single-use cup.
- ✓ Food-safe and flavour-neutral plastic.
- ✓ BPA-free and with no potentially harmful plasticisers.
- ✓ Suitable for all standard cupholders.
- ✓ Made in Germany in accordance with the highest quality standards.
- ✓ Produced with our own green electricity and 100% recyclable



Volume
0,25 l

Item No. 01548

Plastic/Polypropylene
120 mm x Ø 95 mm
72 Unit, Bulk

Volume
0,35 l

Item No. 01549

Plastic/Polypropylene
155 mm x Ø 95 mm
48 Unit, Bulk

2 MUGS. 3 LIDS. MULTIVARIOUS COMBINATIONS.

PREMIUM COFFEE MUGS MADE IN GERMANY

- ✓ Double-walled cup.
- ✓ BPA free and without critical plasticizers.
- ✓ Food safe and tasteless plastic.
- ✓ Made in Germany to the highest quality standards.
- ✓ Production with our own green power and 100% recycable.
- ✓ Big advertising space and photo-realistic finishing possible.
- ✓ Suitable for all common cup holders.

Screw cap with sealing ring.



**INDIVIDUALLY DESIGNABLE
WITH IMOULD, PREMIO TOUCH,
SCREEN & TAMPO PAD PRINT.**

YOUR IMAGINATION - YOUR MUG.

Combine your cup individually.

Double-walled mugs.

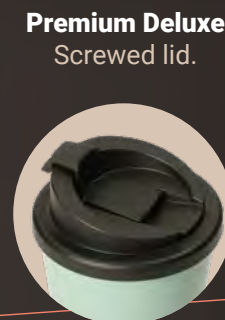

LEAKPROOF

Lid available in numerous colours.



Volume
0,25 l

Plastic/Polypropylene
120 mm x Ø 95 mm
72 Unit, bulk



Item No. 04578
Item No. 14578
Item No. 01215 Frozen



Item No. 01060
Item No. 11060



Item No. 01177
Item No. 11177

Volume
0,35 l

Plastic/Polypropylene
155 mm x Ø 95 mm
48 Unit, bulk

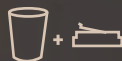

Item No. 04576
Item No. 14576
Item No. 01216 Frozen



Item No. 01063
Item No. 11063



Item No. 01173
Item No. 11173

+ Cuffs for
PREMIUM 0,35 l.

Cuff made of silicone
Item No. 04577

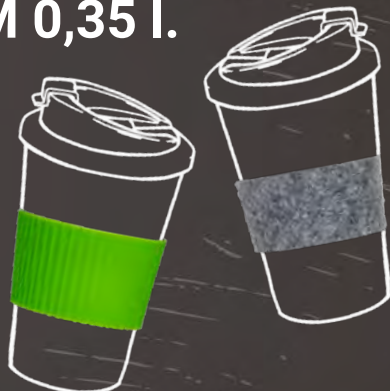

Cuff made of felt
Item No. 04575



ALL CUPS ALSO AVAILABLE IN BIO-PLASTIC,
ANTIBACTERIAL OR AS FROZEN LOOK!

Reusable cup made from recycled disposable cups!

Turn old into new!

We give former disposable coffee cups a 2nd chance!



The outer cup of our new **PAPERINSIDE** cup gets its special look from **cleaned and recycled paper from former disposable coffee cups!**



Sustainable and reusable alternative to the single-use cup.



Food-safe and flavour-neutral plastic.



BPA-free and with no potentially harmful plasticisers.



Made in Germany according to the highest of standards.



Produced with our own green electricity and 100% recyclable.



Suitable for all standard cup holders.

Volume
0,25 l

Item No. 01548

Polypropylene/Paper
120 mm x Ø 95 mm
72 units, loose in a box

Volume
0,35 l

Item No. 01549



Polypropylene/Paper
155 mm x Ø 95 mm
48 units, loose in a box



01271 Coffee cup glass effect

Transparent coffee cup made from shatterproof Tritan in a tapered design with attachable lid. This has two ridged side apertures through which you can safely enjoy even hot drinks. The drink aperture closes with a flexible tab that attaches to the edge of the lid. Capacity: 0.35 litre.



Piece(s)	1	100	500	1000
EUR	4.79	4.28	3.61	3.37

 Plastic/Tritan
 120 mm x Ø 95 mm

 72 Unit, Bulk

01272 Coffee cup glass effect with sleeve

Piece(s)	1	100	500	1000
EUR	6.37	5.70	4.80	4.48

 Plastic/Tritan
 120 mm x Ø 95 mm

 72 Unit, Bulk



01349 Enamel cup „Cozy“, subli

Stylish, retro steel coffee cup with an enamel coating and a stainless steel cup rim. External colour: white. Internal colour: white. Perfect for finishing with sublimation printing. Capacity: 0.3 litre.

Piece(s)	1	100	500	1000
EUR	4.40	4.10	3.77	3.51

Metal/Steel
 80 mm x Ø 85 mm

50 Unit, Individual carton + Polybag



01348 Enamel cup „Cozy“, black

Piece(s)	1	100	500	1000
EUR	4.26	3.82	3.67	3.42

01351 Enamel cup „Cozy“, white

Piece(s)	1	100	500	1000
EUR	3.82	3.52	3.19	2.98

01348
 80 mm x Ø 85 mm
 50 Unit, Individual carton + Polybag

01351
 80 mm x Ø 87 mm
 50 Unit, Individual carton + Polybag

NEW!



01831 Enamel mug „Cozy“, 160 ml, black

Stylish little retro steel coffee mug for your next espresso. With an enamel coating and a stainless steel cup rim. Outer colour: black. Inner colour: white. Filling capacity: 160 ml.

Piece(s)	1	100	500	1000
EUR	3.57	3.20	2.69	2.51

Metal/Steel
 64 mm x Ø 55 mm

120 Unit, Individual carton + Polybag



01832 Enamel mug „Cozy“, 160 ml, white

Piece(s)	1	100	500	1000
EUR	3.42	3.06	2.58	2.41

Metal/Steel
 64 mm x Ø 55 mm

120 Unit, Individual carton + Polybag



14898 Eco-Mug „Arica“

Piece(s)	1	100	500	1000
EUR	3.89	3.48	2.93	2.73



Plastic/Bio-based plastic

72 Unit, Bulk

88 mm x Ø 84 mm



04898 Mug „Arica“

Piece(s)	1	100	500	1000
EUR	3.52	3.15	2.66	2.48



Plastic/ABS

72 Unit, Polybag

88 mm x Ø 84 mm



01360 Cup „Mira“

Piece(s)	1	500	1000	5000
EUR	1.84	1.64	1.38	1.29



Plastic/ABS

72 Unit, Bulk

88 mm x Ø 84 mm



01524 Cup „Mira“, Tritan

Piece(s)	1	500	1000	5000
EUR	2.25	2.01	1.70	1.58



Plastic/Tritan

72 Unit, Bulk

88 mm x Ø 84 mm



04900 Tea Cup

Piece(s)	1	100	500	1000
EUR	3.59	3.21	2.71	2.52



Plastic/Tritan

50 Unit, Bulk

88 mm x Ø 84 mm



08962 Cup „Nice Day“

Piece(s)	1	100	500	1000
EUR	3.33	2.98	2.51	2.34

Ceramic

36 Unit, Polybag



95 mm x Ø 80 mm



01282 Drinking glass „Crystal“, 0.04 l

Looks like crystal glass - but is much less likely to break! Transparent small drinking glass made from AS with an elaborate crystal design. Capacity: 0.04 litre.

Piece(s)	1	100	500	1000
EUR	2.51	2.24	1.89	1.76

 Plastic/SAN
 70 mm x Ø 40 mm

 240 Unit, Bubble wrap + Polybag







01281 Long drink glass „Crystal“, 0.3 l

Piece(s)	1	100	500	1000
EUR	3.96	3.55	2.99	2.79

01283 Drinking glass „Crystal“, 0.3 l

Piece(s)	1	100	500	1000
EUR	4.50	4.03	3.39	3.17

01281
 149 mm x Ø 65 mm
 72 Unit, Bubble wrap + Polybag

01283
 99 mm x Ø 78 mm
 60 Unit, Bubble wrap + Polybag



01347 Stainless steel cup „Metallo“

The alternative to substandard disposable cups! High-quality, sturdy cup made from stainless steel. Easily stackable and very hard-wearing. Capacity: 0.27 litre.

Piece(s)	1	100	500	1000
EUR	3.20	2.86	2.41	2.25

Metal/Stainless steel 200 Unit, Polybag
 120 mm x Ø 74 mm



01274 Drinking cup glass effect

Looks like glass, but is half the weight. Light, tapered drinking cup made from shatterproof Tritan. Enjoy your drink in this neutral tasting, odourless cup. Capacity: 0.35 litre.

Piece(s)	1	100	500	1000
EUR	3.45	3.09	2.60	2.43

Plastic/Tritan 72 Unit, Bulk
 110 mm x Ø 90 mm



05263 Drinking cup „Caipi“

Never break a glass on the counter again. Elegant cocktail glass consisting of stable and pleasantly smooth plastic. Practical design featuring 0.25 and 0.3 litres markings on exterior.

Piece(s)	1	500	1000	5000
EUR	2.22	1.96	1.65	1.54

Plastic/SAN 100 Unit, Bulk
 133 mm x Ø 85 mm



05133 Cup „Tumble“

The little one, which contains a lot. Elegant spirits glass made of sturdy and pleasantly smooth plastic material. Handy with embossing of 0.25 litre marking.

Piece(s)	1	500	1000	5000
EUR	1.34	1.20	1.01	0.94

Plastic/SAN 150 Unit, Bulk
 83 mm x Ø 85 mm





05118 Beaker „Liquor“

Transparent, high gloss polished beaker made of sturdy SAN (plastic) in the shape of a whiskey glass. When the beaker is filled with a coloured beverage the double wall creates a fantastic effect. With filling mark. Fill capacity: 0.2 litres.

Piece(s)	1	500	1000	5000
EUR	2.00	1.79	1.51	1.41

Plastic/SAN

50 Unit, Bulk

100 mm x Ø 85 mm



05098 Drinking cup „Ergonomic“ 0.2 l

Patented cup with nose cutout and measuring scale (0.05/0.1/0.15/0.2 litres). Perfect for people who can't move their head back without help. Made of food safe, transparent plastic for easy monitoring of the fluid intake.

Piece(s)	1	500	1000	5000
EUR	2.11	1.89	1.59	1.48



Plastic/Polypropylene

200 Unit, Bulk

118 mm x Ø 68 mm



05074 Drinking cup „Rip“ 0.4 l

Stackable, break-proof returnable cup with easy-grip structure. Capacity: 0.4 litres.

Piece(s)	1	500	1000	5000
EUR	1.87	1.68	1.41	1.32



Plastic/Polystyrene

100 Unit, Bulk

115 mm x Ø 85 mm



05065 Drinking cup „Drink safe“

Tightly sealing drinking cup made of plastic with an additional large advertising space on the lid. Capacity: 0.33 litres.

Piece(s)	1	100	500	1000
EUR	3.20	2.86	2.41	2.25



Plastic/SAN

60 Unit, Bulk

140 mm x Ø 70 mm



05119 Drinking beaker „promotion“

Double layered beakers made from clear PS plastic. The selling point for these drinking beakers is the individually equipped depositor between the two layers. The depositor cannot be removed and guarantees a durable product. Capacity: 0.3 litres.

Piece(s)	1	100	500	1000
EUR	2.38	2.13	1.80	1.68

Plastic/Polystyrene
117 mm x Ø 79 mm

50 Unit, Polybag



05050 Drinking cup set „Travel“

It's picnic time. 4 stackable cups, with lid. Assorted colours with white lid. Capacity: 0.15 litres per cup.

Piece(s)	1	500	1000	5000
EUR	1.72	1.54	1.29	1.21

Plastic/Polypropylene
127 mm x Ø 67 mm

100 Unit, Bulk



05089 Drinking cup „Colour“ 0.4 l

Cup with easy-grip structure. Available in a selection of colours. Without saucer. Capacity: 0.4 litres.

Piece(s)	1	500	1000	5000	
EUR	1.28	1.14	0.96	0.90	

Plastic/Polypropylene
136 mm x Ø 87 mm

100 Unit, Bulk



05088 Drinking cup „Colour“ 0.5 l

Piece(s)	1	500	1000	5000	
EUR	1.50	1.34	1.13	1.05	

Plastic/Polypropylene
163 mm x Ø 87 mm

100 Unit, Bulk



15089 Eco-Cup „Colour“ 0.4 l

Just right for quenching your thirst! Sturdy, easily stackable drinking cup. Made of organic plastic and available in many beautiful natural colours. Capacity: 0.4 litre.

Piece(s)	1	100	500	1000
EUR	2.42	2.17	1.83	1.70



Plastic/Bio-based plastic
 136 mm x Ø 87 mm

150 Unit, Bulk

15088 Eco-Cup „Colour“ 0.5l

Piece(s)	1	500	1000	5000
EUR	2.27	2.03	1.71	1.60



Plastic/Bio-based plastic
 163 mm x Ø 87 mm

100 Unit, Bulk



05083 Drinking cup „Returnable“ 0.4 l

Transparent plastic cup with filling level mark. Capacity: 0.4 litres.

Piece(s)	1	500	1000	5000	
EUR	1.25	1.12	0.95	0.88	

Plastic/Polypropylene
 132 mm x Ø 87 mm

100 Unit, Bulk

05082 Drinking cup „Returnable“ 0.5 l

Piece(s)	1	500	1000	5000	
EUR	1.36	1.22	1.03	0.96	

05125 Drinking cup „Deposit“ 0.4 l paintable

Piece(s)	1	500	1000	5000
EUR	2.29	2.05	1.73	1.61

05082
 164 mm x Ø 87 mm
 100 Unit, Bulk

05125
 136 mm x Ø 87 mm
 150 Unit, Bulk



05086 Drinking cup „Deposit“ 0.3 l

Stackable, break-proof, returnable cup made of transparent plastic with filling level mark. IMould labelling possible. Capacity: 0.3 litres.

Piece(s)	1	500	1000	5000	
EUR	0.88	0.79	0.67	0.62	

Plastic/Polypropylene
 114 mm x Ø 87 mm

200 Unit, Bulk



05084 Drinking cup „Deposit“ 0.5 l

Piece(s)	1	500	1000	5000	
EUR	1.02	0.92	0.77	0.72	

05081 Drinking cup „Deposit“ 0.4 l

Piece(s)	1	500	1000	5000	
EUR	0.99	0.88	0.75	0.70	

05084
 166 mm x Ø 87 mm
 150 Unit, Bulk

05081
 132 mm x Ø 87 mm
 200 Unit, Bulk



05080 Drinking cup „Mini Cup“ 0.2 l

Break-proof returnable cup, easy to grip thanks to light structure and grooves. Advertising on drinking rim possible as of 5000 units. Capacity: 0.2 litres.

Piece(s)	1	500	1000	5000	
EUR	0.65	0.58	0.49	0.46	

Plastic/Polypropylene
 75 mm x Ø 72 mm

500 Unit, Bulk



05097 Drinking cup „Maxi Cup“ 0.4 l

Piece(s)	1	500	1000	5000	
EUR	1.03	0.92	0.77	0.72	

05094 Drinking cup „Midi Cup“ 0.3 l

Piece(s)	1	500	1000	5000	
EUR	0.93	0.83	0.70	0.65	

05097
 130 mm x Ø 83 mm
 250 Unit, Bulk

05094
 105 mm x Ø 80 mm
 300 Unit, Bulk



01053 Drinking cup „Turin“

Ideal for parties and festivals. Transparent, single-walled cup with a volume of 0.4 litres.

Piece(s)	1	500	1000	5000	
EUR	0.94	0.84	0.71	0.66	

Plastic/Polypropylene 300 Unit, Bulk
 123 mm x Ø 63 mm

01054 Drinking cup „Turin“ with lid

Piece(s)	1	500	1000	5000
EUR	2.30	2.06	1.74	1.62

Plastic/Polypropylene 60 Unit, Bulk
 140 mm x Ø 63 mm



05067 Drinking cup „Take Away“ 0.3 l

Stackable, break-proof returnable cup with lid, straw and strap holder. IMould labelling possible. Capacity: 0.3 litres.

Piece(s)	1	500	1000	5000	
EUR	2.55	2.28	1.92	1.79	

Plastic/Polypropylene 50 Unit, Bulk
 118 mm x Ø 90 mm

05070 Drinking cup „Take Away“ 0.5 l

Piece(s)	1	100	500	1000	
EUR	2.88	2.58	2.17	2.03	

05068 Drinking cup „Take Away“ 0.4 l

Piece(s)	1	100	500	1000	
EUR	2.68	2.40	2.02	1.89	

05070
 Plastic/Polypropylene 40 Unit, Bulk
 170 mm x Ø 90 mm

05068
 Plastic/Polypropylene 50 Unit, Bulk
 135 mm x Ø 90 mm





SALE!

09405 Beer mug „Bavarian“ 0.25 l

For the small thirst for beer. Classic beer mug made from white porcelain with handle. Capacity: 0.25 litres

Piece(s)	1	50	250	500
EUR	8.17	7.31	6.09	5.69



 Ceramic
 106 mm x Ø 85 mm

 36 Unit, Polybag

09403 Beer mug „Bavarian“ 0.5 l

A mug for a good and cold Bavarian beer. Classic beer mug made from white porcelain featuring a large handle. Capacity: 0.5 litres

Piece(s)	1	50	250	500
EUR	8.87	7.94	6.68	6.23

 Ceramic
 140 mm x Ø 95 mm

 18 Unit, Polybag



01045 Shaker „Protein“ small

Prepare a protein shake after the work out. This transparent shaker with embossed scale divided in steps of 50 ml and screw cap with lockable drinking opening contains a removable screen so that the liquid and the shaking powder mix optimally. The shaker can be completely disassembled and therefore cleaned thoroughly. Capacity: 0.4 litres

Piece(s)	1	100	500	1000	
EUR	3.04	2.72	2.29	2.14	

Plastic/Polypropylene 38 Unit, Bulk
 160 mm x Ø 78 mm



04456 Shaker „Protein“

Prepare a protein shake after the work out. This transparent shaker with embossed scale divided in steps of 50 ml and screw cap with lockable drinking opening contains a removable screen so that the liquid and the shaking powder mix optimally. The shaker can be completely disassembled and therefore cleaned thoroughly. Capacity: 0.6 litres.

Piece(s)	1	100	500	1000	
EUR	3.43	3.07	2.59	2.41	

Plastic/Polypropylene 40 Unit, Polybag
 200 mm x Ø 96 mm



NEW!

01855 Shaker „Protein“, Pro, 0.40 l, Version 1

Shake it up! Ideal for a protein shake after training. This shaker contains a closable drinking aperture and an embossed measurement scale in 50ml increments. It also comes with a removable sieve, so a thorough shake is all that's needed for the perfect mix of protein powder and liquid. This shaker also has a screw-off compartment which can be filled separately. It can be completely disassembled, making it very easy to clean. Fill quantity (shaker without additional compartment): 0.4 litres.

Piece(s)	1	100	500	1000	
EUR	4.24	3.79	3.20	2.98	

Plastic/Polypropylene Bulk
 208 mm x Ø 96 mm



01857 Shaker „Protein“, Pro, 0.40 l, Version 3

Piece(s)	1	100	500	1000	
EUR	5.46	4.89	4.12	3.84	

01856 Shaker „Protein“, Pro, 0.40 l, Version 2

Piece(s)	1	100	500	1000	
EUR	4.90	4.38	3.69	3.45	

01857
 228 mm x Ø 96 mm
 Bulk

01856
 228 mm x Ø 96 mm
 Bulk





14456 Eco-Shaker „Protein“

Perfect for making a post-workout protein shake. This transparent screw-top shaker contains a closable drinking aperture and an embossed measurement scale in 50ml increments. It also comes with a removable sieve, so a thorough shake is all that's needed for the perfect mix of protein powder and liquid. It can be completely disassembled, which makes it very easy to clean. Made of organic plastic and available in many beautiful natural colours. Capacity: 0.6 litre.

Piece(s)	1	100	500	1000
EUR	4.53	4.06	3.42	3.19



 Plastic/Bio-based plastic
 200 mm x Ø 96 mm

 40 Unit, Bulk



05108 Shaker „Lagoon“ 0.5 l

Transparent cup and lid with screw top. Ideal for mixing of shakes or other mixed drinks including fill line. Capacity: 0.5 litre.

Piece(s)	1	500	1000	5000	
EUR	2.12	1.90	1.60	1.49	

Plastic/Polypropylene 40 Unit, Bulk
 220 mm x Ø 90 mm



05066 Shaker „Multi“

With translucent cup and full-colour twist off lid. Perfect for mixed drinks or for storing household ingredients. Capacity: 0.3 litres.

Piece(s)	1	500	1000	5000	
EUR	1.90	1.70	1.43	1.34	

Plastic/Polypropylene 60 Unit, Bulk
 156 mm x Ø 88 mm



09593 Cereal beaker „Spoon“

The perfect breakfast beaker. Double-walled, transparent plastic beaker with extra fillable lid. Ideal for transporting yogurt or milk and the cereals or other ingredients separately. The enclosed plastic spoon is stored inside the holder on the silicone sleeve.

Piece(s)	1	100	500	1000
EUR	3.23	2.99	2.67	2.49

Plastic/Polystyrene 50 Unit, Individual carton + Bubble wrap
 100 mm x 175 mm x Ø 90 mm



**11164 Eco-Muesli Bowl „1-Colour“
matt finish**

Piece(s)	1	100	500	1000
EUR	3.83	3.43	2.89	2.70



Plastic/Bio-based plastic
80 mm x Ø 136 mm

45 Unit, Bulk



**15145 Eco-Muesli Bowl „2-Colour“
matt finish**

Piece(s)	1	100	500	1000
EUR	4.57	4.09	3.44	3.21



Plastic/Bio-based plastic
80 mm x Ø 136 mm

45 Unit, Bulk



01164 Cereal bowl „1 Colour“ matt finish

Piece(s)	1	500	1000	5000
EUR	2.40	2.15	1.81	1.69



Plastic/Polypropylene
80 mm x Ø 136 mm

45 Unit, Bulk



05145 Cereal bowl „2 Colour“ matt

Piece(s)	1	100	500	1000
EUR	3.76	3.36	2.83	2.64



Plastic/Polypropylene
80 mm x Ø 136 mm

45 Unit, Bulk



01218 Muesli Bowl „2-Colour“ Frozen

Piece(s)	1	100	500	1000
EUR	3.76	3.36	2.83	2.64



Plastic/Polypropylene
Ø 136 mm

45 Unit, Bulk



05136 Cereal bowl „2 Colour“

Piece(s)	1	100	500	1000
EUR	3.49	3.13	2.63	2.46



Plastic/Polypropylene
80 mm x Ø 136 mm

45 Unit, Bulk





15135 Eco-Muesli Bowl „Good Morning“

A bowl does not always have to be round. Great square-brimmed muesli bowl with excellent grip and hold at the edges. Very good for stacking. Made of organic plastic and available in many beautiful natural colours.

Piece(s)	1	500	1000	5000
EUR	1.89	1.69	1.42	1.33



 Plastic/Bio-based plastic  200 Unit, Bulk
 162 mm x 162 mm x 62 mm





01273 Cereal bowl „Cereal“

High-quality PP bowl - ideal for camping, kids birthdays, picnics, barbecues and plenty more - sturdy but light. This reusable cereal bowl has a tapered design. The bowls allow compact stacking and can be produced in lots of different colours. Capacity: 0.5 litre.

Piece(s)	1	500	1000	5000
EUR	1.28	1.14	0.96	0.90



 Plastic/Polypropylene  125 Unit, Bulk
 70 mm x Ø 140 mm





05135 Cereal bowl „Good morning“

A bowl does not necessarily have to be round. Great breakfast bowl in a rectangular shape with a rim for a better grip. Stackable.

Piece(s)	1	500	1000	5000
EUR	1.20	1.07	0.91	0.84



 Plastic/Polypropylene  200 Unit, Bulk
 162 mm x 162 mm x 62 mm



05046 Bowl „Breakfast“

Stackable, attractive muesli dish with practical handles. Available in a large selection of trendy colours. Capacity: 0.5 litres.

Piece(s)	1	500	1000	5000	
EUR	1.06	0.95	0.80	0.75	

Plastic/Polypropylene 150 Unit, Bulk
 164 mm x 140 mm x 76 mm



04543 Snack cup „Snaxiko“

In this way, the chips will jump for joy. Great, stable snack bowl made from plastic in triangular shape. One corner is separated by a wall and therefore ideal for filling in dips or sauces. Optimal for tortilla chips thanks to its exceptional shape.

Piece(s)	1	500	1000	5000	
EUR	1.75	1.57	1.32	1.23	

Plastic/Polypropylene 40 Unit, Bulk
 212 mm x 199 mm x 55 mm



04544 Popcorn bowl „Hollywood“

Whether sweet or salty ... this box offers enough space for a big portion of popcorn. Completely made of PP. Easy to clean and reusable.

Piece(s)	1	500	1000	5000	
EUR	2.43	2.17	1.83	1.71	

Plastic/Polypropylene 50 Unit, Bulk
 140 mm x 140 mm x 173 mm

04545 Popcorn bowl „Hollywood“, with stripes

Piece(s)	1	100	500	1000	
EUR	3.39	3.03	2.56	2.38	

Plastic/Polypropylene 50 Unit, Bulk
 140 mm x 140 mm x 173 mm



01352 Snack bowl „Imbiss“

Just cardboard? You're wrong! This oval-shaped bowl in ABS is an original designer piece that will make you smile and is a totally new interpretation of the used look. It looks like a classic paper bowl but can be used again and again.

Piece(s)	1	500	1000	5000	
EUR	1.57	1.40	1.18	1.10	

Plastic/ABS 100 Unit, Bulk
 200 mm x 115 mm x 40 mm



01353 Snack bowl „Imbiss“ with lid

Piece(s)	1	100	500	1000	
EUR	2.84	2.54	2.14	2.00	

Plastic/ABS 60 Unit, Bulk
 204 mm x 119 mm x 43 mm

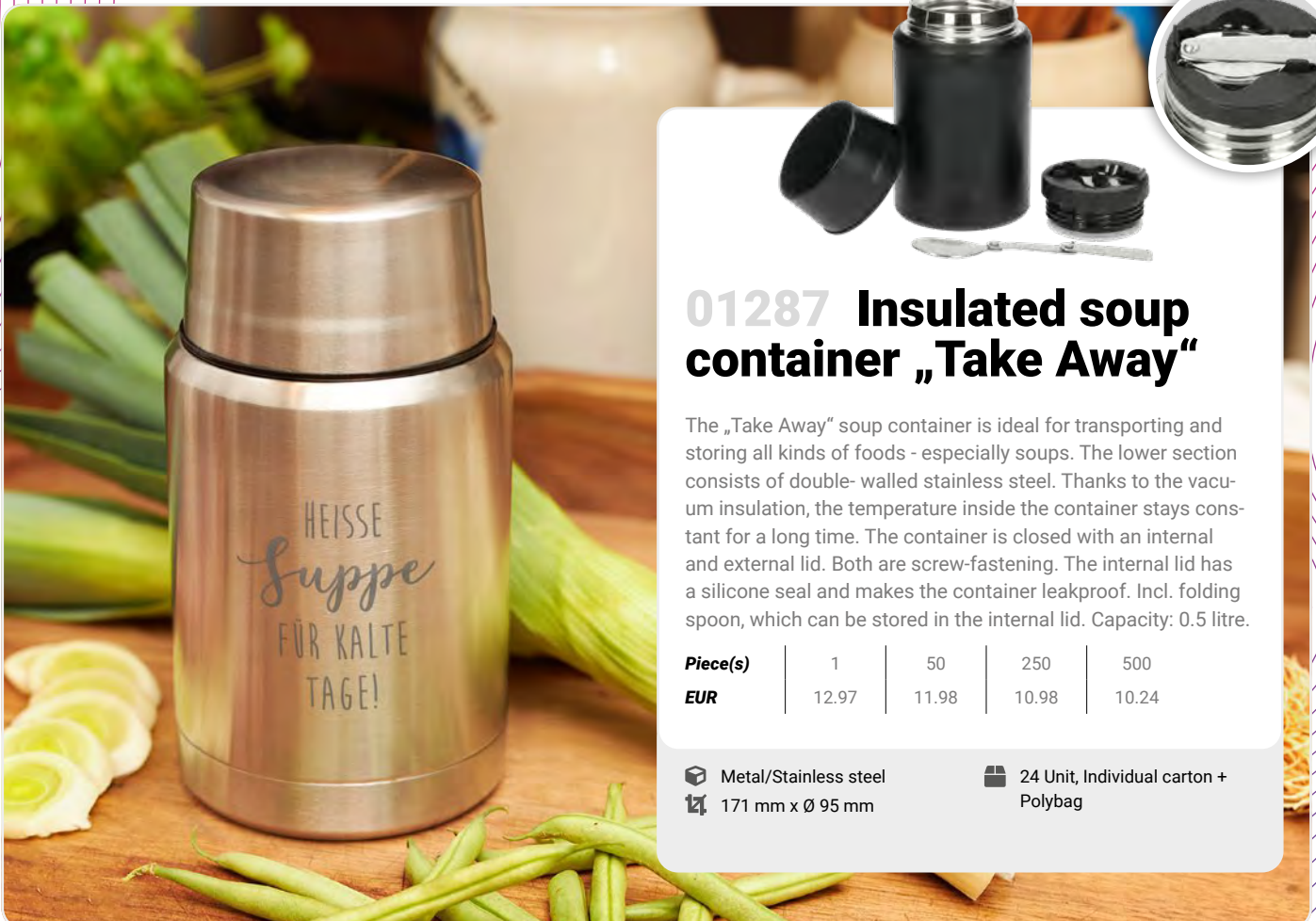

01287 Insulated soup container „Take Away“

The „Take Away“ soup container is ideal for transporting and storing all kinds of foods - especially soups. The lower section consists of double-walled stainless steel. Thanks to the vacuum insulation, the temperature inside the container stays constant for a long time. The container is closed with an internal and external lid. Both are screw-fastening. The internal lid has a silicone seal and makes the container leakproof. Incl. folding spoon, which can be stored in the internal lid. Capacity: 0.5 litre.

Piece(s)	1	50	250	500
EUR	12.97	11.98	10.98	10.24

Metal/Stainless steel 24 Unit, Individual carton + Polybag
 171 mm x Ø 95 mm

No more single-use takeaway packaging!

Put an end to unnecessary waste with our new reusable takeaway boxes.

They are the sustainable alternative to disposable packaging and offer enough room to hold and safely transport both warm and cold foods! Our products are 100% **MADE IN GERMANY**.



Made in Germany.



Eco-friendly.



Individual.



Suitable for the dishwasher.



Microwaveable.



Durable.

Colours.



Gregarious GREEN



Sophisticated RED



Comfortable BLUE



Basic BROWN



Plain BLACK

Nice to know.

If our boxes have done their job, we'll take them back for free and recycle them fully. A wonderful new item will be made from the recycled material, which is sure to make someone else happy.



**01724 Meal box
„ToGo“ medium**

500 pcs. from **2.88€**



**01743 Meal box
„ToGo“ large**

500 pcs. from **4.25€**

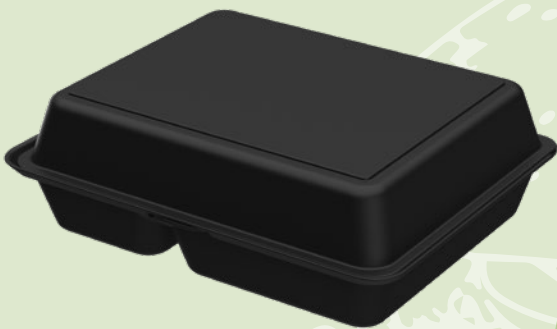

No more single-use takeaway packaging!

NEW!

**01808 Drinking cup
„ToGo“ 0.3 l**

500 pcs. from **0.65€**



NEW!

**01822 Lid
„ToGo“**

500 pcs. from **0.23€**

NEW!

**01854 Coffee mug
„ToGo“, 0.3 l**

500 pcs. from **0.88€**



**01744 Burger box
„ToGo“**

500 pcs. from **2.66€**





**07406 Sandwich box
„ToGo“**

1000 pcs. from **0.98€**

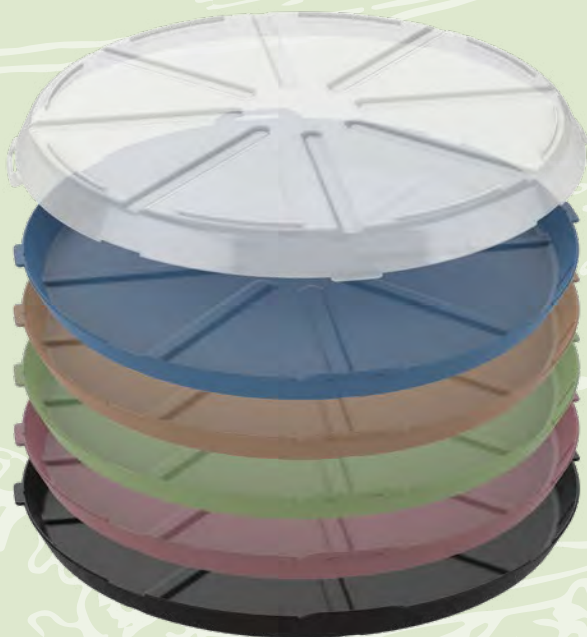

NEW!

**01834 Pizza box
„ToGo“**

500 pcs. from **7.69€**



No more single-use takeaway packaging!

NEW!

**01766 Food-Bowl
„ToGo“, 1.0 l**

500 pcs. from **4.85€**

NEW!

**01768 Food-Bowl
„ToGo“, 2,2 l**

500 pcs. from **6.46€**

**05109 Meal box
„ToGo“ round**

500 pcs. from **2.64€**



05200 Universal box „ToGo“

500 pcs. from **3.52€**



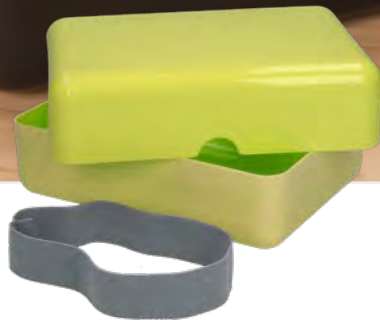

04568 Lunch box „Match“

Retro but trendy. Great, spacious lunchbox consisting of two square bowls that are held together by an elastic strap (65 % polyester, 35 % latex). The lid can be completely put over the bottom part, it can be easily removed thanks to the lateral openings. IMould finishing possible.

Piece(s)	1	100	500	1000	
EUR	3.23	2.89	2.43	2.27	

Plastic/Polypropylene
 45 Unit, Bulk
 179 mm x 130 mm x 61 mm



14568 Eco-Lunchbox „Match“

A touch retro, but still totally fashionable. Spacious lunchbox comprising two rectangular bowls attached by an elastic band (65 % polyester, 35 % latex). The lid can be completely pulled over the base, but its side recesses also make it easy to remove. IMould branding possible. Made of organic plastic and available in many beautiful natural colours.

Piece(s)	1	100	500	1000	
EUR	5.00	4.48	3.77	3.52	

Plastic/Bio-based plastic
 45 Unit, Bulk
 179 mm x 130 mm x 61 mm



NEW!

01859 Lunch box „Beech“

A real eye-catcher in the lunchroom. The chic storage box consists of three components: A tray made of food-safe plastic, a lid made of beech wood and an elastic band that holds the tin securely together. As the material of the lid is natural beech wood, there may be variations in colour and grain.

Piece(s)	1	100	500	1000	GER
EUR	6.80	6.09	5.13	4.79	

Plastic/Polypropylene
205 mm x 110 mm

Bulk



15236 Eco-Lunch box „School-Box“, large

Generous storage box with click-fastening. It's ideal for storing and transporting sandwiches. It's ideal for all kinds of foods and is BPA-free. The top is perfect for finishing using the IMould process. Made of organic plastic and available in many beautiful natural colours.

Piece(s)	1	100	500	1000	GER
EUR	2.39	2.14	1.80	1.68	

Plastic/Bio-based plastic
175 mm x 128 mm x 69 mm

50 Unit, Bulk



05236 Lunch box „School box“ large

Great sandwich box with 1 snap fastener. Available in a large selection of colours. IMould labelling possible.

Piece(s)	1	500	1000	5000	GER
EUR	1.75	1.57	1.32	1.23	

Plastic/Polypropylene
175 mm x 131 mm x 68 mm

50 Unit, Bulk



01032 Lunch box „School Box“ large with separating bowl

Piece(s)	1	100	500	1000	GER
EUR	2.71	2.42	2.04	1.91	

Plastic/Polypropylene
175 mm x 128 mm x 69 mm

50 Unit, Bulk



05282 Storage box „School box“ middle

Practical, small snack box with 1 click closure. Available in many colours. IMould finish possible.

Piece(s)	1	500	1000	5000	
EUR	1.86	1.66	1.40	1.31	

Plastic/Polypropylene 60 Unit, Bulk
 160 mm x 116 mm x 50 mm

05276 Storage Box „School Box“ medium with separator

Piece(s)	1	500	1000	5000	
EUR	1.86	1.66	1.40	1.31	

Plastic/Polypropylene 60 Unit, Bulk
 160 mm x 116 mm x 50 mm



05297 Lunch box „School Box“ deluxe, with compartment divider

A spacious lunchbox made of PP with click closure and removable compartment divider, which separates various foods during storage and transportation. The box is food-safe and 100% BPA-free. Its surface is perfect for an Imould logo.

Piece(s)	1	100	500	1000	
EUR	3.47	3.11	2.62	2.44	

Plastic/Polypropylene 40 Unit, Bulk
 190 mm x 139 mm x 70 mm

05296 Lunch box „School Box“ deluxe, without separating sleeve

Piece(s)	1	100	500	1000	
EUR	2.63	2.35	1.98	1.85	

Plastic/Polypropylene 40 Unit, Bulk
 190 mm x 139 mm x 70 mm



05268 Storage box „School box“ junior

Practical, small snack box with 1 click closure. Available in many colours. IMould finish possible. Matches perfectly the large „School box“ large storage box (05236).“

Piece(s)	1	500	1000	5000	
EUR	1.21	1.08	0.91	0.85	

Plastic/Polypropylene 80 Unit, Bulk
 160 mm x 117 mm x 41 mm



05298 Lunch box „School Box“ deluxe, bear version

Something special. Big lunchbox made of PP with click closure and embossed bear-motif which adds a special tactile effect. Ideal for the storage and transportation of various foods. The box is food-safe and 100% BPA-free. Individual embossed motifs on request.

Piece(s)	1	100	500	1000	
EUR	2.63	2.35	1.98	1.85	

Plastic/Polypropylene 40 Unit, Bulk
 190 mm x 139 mm x 70 mm



05299 Lunch box „Cube“ deluxe

Compact lunchbox in square format with one click closure. Thanks to the shape and the ample height, it is ideal for bread rolls and sandwiches. IMould finishing possible.

Piece(s)	1	100	500	1000	
EUR	2.68	2.40	2.03	1.89	

Plastic/Polypropylene 48 Unit, Bulk
 140 mm x 140 mm x 65 mm



05301 Lunch box „Cube“ deluxe, with compartment divider

Piece(s)	1	100	500	1000	
EUR	3.41	3.05	2.57	2.40	

Plastic/Polypropylene 48 Unit, Bulk
 140 mm x 140 mm x 65 mm



05244 Lunch box „Break box“

Ideal snack box with 1 snap fastener and separator ideal for different foods. Available in a large selection of colours. IMould labelling possible.

Piece(s)	1	100	500	1000	
EUR	2.01	1.80	1.52	1.41	

Plastic/Polypropylene 50 Unit, Bulk
 175 mm x 128 mm x 69 mm



05230 Lunch box „Break“

Practical, budget storage box made of ultra-light material. Keeps your sandwiches or other foods fresh. With 1 snap fastener.

Piece(s)	1	500	1000	5000	
EUR	1.14	1.02	0.86	0.80	

Plastic/Polypropylene 60 Unit, Bulk
 153 mm x 105 mm x 55 mm



05243 Lunch box „Lunch box“

Ideal for your sandwiches. Available in a large selection of colours. With 1 snap fastener. IMould labelling possible.

Piece(s)	1	500	1000	5000	
EUR	1.98	1.78	1.49	1.39	

Plastic/Polypropylene 60 Unit, Bulk
 162 mm x 113 mm x 50 mm



05283 Storage box „Lunch-Box“ to paint on

Piece(s)	1	100	500	1000	
EUR	3.14	2.81	2.37	2.21	

Plastic/Polypropylene 60 Unit, Bulk
 162 mm x 113 mm x 50 mm

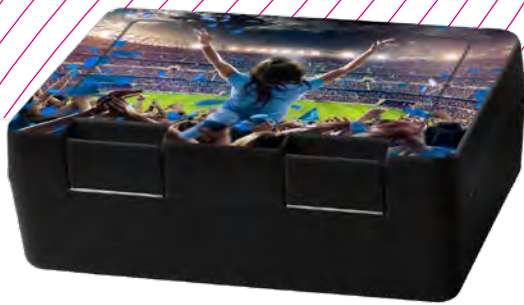

05245 Lunch box „Dinner box“

For large appetites. Available in a large selection of colours. With 2 snap fasteners. IMould labelling possible.

Piece(s)	1	100	500	1000	
EUR	2.49	2.23	1.88	1.75	

Plastic/Polypropylene 40 Unit, Bulk
 180 mm x 130 mm x 65 mm



05025 Lunch box „Dinner Box Plus“

Piece(s)	1	100	500	1000	
EUR	3.02	2.71	2.28	2.13	

Plastic/Polypropylene 36 Unit, Bulk
 180 mm x 130 mm x 65 mm



05104 Lunch box „Twin Box“ with separating wall

Useful storage box featuring smart panel door system and separating wall. Both doors may be enhanced with different motifs via the IMould process. Both click seals ensure increased stability. (Article no. without separating wall 05102).

Piece(s)	1	100	500	1000	
EUR	2.92	2.62	2.21	2.06	

Plastic/Polypropylene 50 Unit, Bulk
 160 mm x 160 mm x 50 mm



05102 Lunch box „Twin Box“ without separating wall

Piece(s)	1	100	500	1000	
EUR	2.53	2.26	1.91	1.78	

Plastic/Polypropylene 50 Unit, Bulk
 160 mm x 160 mm x 50 mm



05242 Storage box „Brunch box“

The perfect biscuit and snack jar. Available in a large selection of colours. With 1 snap fastener. IMould labelling possible.

Piece(s)	1	500	1000	5000	
EUR	1.29	1.15	0.97	0.91	

Plastic/Polypropylene 120 Unit, Bulk
 125 mm x 85 mm x 40 mm



05231 Storage box „Flat box“

Flat, practical, budget storage box made of ultra-light material. Keeps your sandwiches or other foods fresh. With 2 snap fasteners. IMould labelling possible.

Piece(s)	10000	20000	
EUR	1.27	1.17	

Plastic/Polypropylene 50 Unit, Bulk
 185 mm x 130 mm x 43 mm



05247 Storage box „Snack box“

Ideal for a small snack. With 2 snap fasteners available in a large selection of colours. IMould labelling possible.

Piece(s)	1	500	1000	5000	
EUR	1.87	1.67	1.41	1.31	

Plastic/Polypropylene 50 Unit, Bulk
 180 mm x 125 mm x 42 mm



05253 Lunch box „Picnic“

A big breakfast or a big snack: this spacious box will keep you satisfied. The straight shape makes optimum use of the available space. The overlapping edge and snap fastener keep food fresh for longer.

Piece(s)	1	100	500	1000	
EUR	2.86	2.56	2.16	2.01	

Plastic/Polypropylene 26 Unit, Bulk
 157 mm x 212 mm x 71 mm





05632 Lunch box „Foodbox“

This beautiful lunchbox with rounded corners and high-gloss polished interior surface impresses with its groove-free lid which allows even finishing. Ideal for IMould finishing.

Piece(s)	1	500	1000	5000	
EUR	1.96	1.76	1.48	1.38	

 Plastic/Polypropylene

 50 Unit, Bulk

 165 mm x 115 mm x 65 mm







15389 Eco-Lunchbox „Switch“

Two is better than one. Lunchbox with double-click closure and insertable hinge for a secure hold. Both halves of the box can be made in different colours and branding with IMould motifs, to allow for more advertising space and to capture even more attention. Made of organic plastic and available in many beautiful natural colours.

Piece(s)	1	100	500	1000
EUR	4.56	4.08	3.44	3.21



 Plastic/Bio-based plastic

 145 mm x 125 mm x 50 mm

 60 Unit, Bulk



05389 Lunch box „Switch“

The box with 2 faces. Lunchbox with double-click closure for safe closure and with plug-in hinge. The two halves can be produced in different colours and finished with an IMould motif for a larger advertising space and a higher attention factor.

Piece(s)	1	100	500	1000	
EUR	2.68	2.40	2.02	1.89	

Plastic/Polypropylene 60 Unit, Bulk
 145 mm x 125 mm x 50 mm



05235 Storage box „Multi box“

Versatile storage box with snap fastener. Perfect for keeping your sandwiches or even crayons.

Piece(s)	1	500	1000	5000	
EUR	2.06	1.84	1.55	1.45	

Plastic/Polypropylene 70 Unit, Bulk
 195 mm x 81 mm x 49 mm



05035 Lunch box „Arena“

Fantastic storage box in stadium look with 1 snap fastener and trendy surface structure.

Piece(s)	1	500	1000	5000	
EUR	2.47	2.21	1.87	1.74	

Plastic/Polypropylene 50 Unit, Bulk
 180 mm x 156 mm x 50 mm



05241 Storage box „Slim box“

Universal, space-saving flat box with 2 snap fasteners and space for 2 slices of toast. IMould labelling possible.

Piece(s)	1	100	500	1000	
EUR	2.50	2.24	1.89	1.76	

Plastic/Polypropylene 100 Unit, Bulk
 185 mm x 128 mm x 18 mm



05237 Storage box „Mini box“

Practical storage box with 1 snap fastener available in a large selection of colours. Perfect for round cheese.

Piece(s)	1	500	1000	5000	
EUR	0.96	0.86	0.73	0.68	

Plastic/Polypropylene
 40 mm x Ø 105 mm

100 Unit, Bulk



05250 Storage box „Fresh box“

With a total of 5 separate compartments for different foodstuffs. With 1 snap fastener.

Piece(s)	1	100	500	1000	
EUR	4.08	3.65	3.08	2.87	

Plastic/Polypropylene
 167 mm x 143 mm x 87 mm

24 Unit, Bulk



05269 Lunch To Go

Practical snack container with handle and folding lid with snap-closure. The lid has two holders for the matching utensils (05274, Box with utensils). The box is made of plastic.

Piece(s)	1	100	500	1000	
EUR	2.61	2.34	1.97	1.84	

Plastic/Polypropylene
 185 mm x 135 mm x 53 mm

40 Unit, Bulk



05274 Lunch To Go Plus

Practical snack container with handle and folding lid with snap-closure. The box lid also has the matching utensils integrated. The storage container and utensils are made completely of plastic.

Piece(s)	1	100	500	1000	
EUR	3.49	3.12	2.63	2.45	

Plastic/Polypropylene
 185 mm x 135 mm x 53 mm

40 Unit, Bulk



01270 Storage box „Take it“

For your next snack. Practical container, consisting of two bowls which are linked using a PP ring. The bowls are ideally suited for an all-over UV digitally printed finish. The box is closed using click-fastening.

Piece(s)	1	100	500	1000	
EUR	5.25	4.70	3.96	3.69	

Plastic/ABS

50 Unit, Bulk

120 mm x 160 mm x 70 mm





05037 Storage box „Apple box“

Round box with space for 1 apple. Ideal for protecting the apple against bruising. 1 snap fastener.

Piece(s)	1	500	1000	5000	
EUR	1.19	1.06	0.90	0.84	

Plastic/Polypropylene 50 Unit, Bulk
 Ø 95 mm

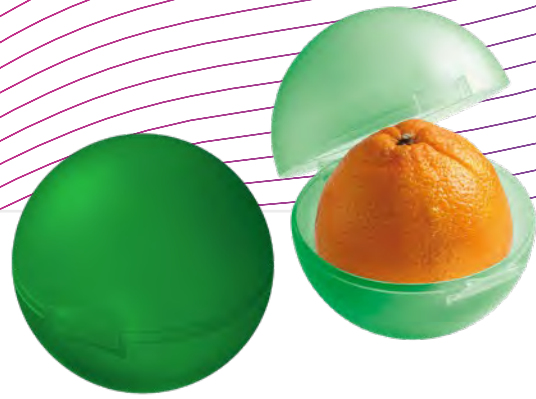

05032 Storage box „Orange Box“

Round box with space for 1 orange. Ideal for protecting the orange against bruising. With click fastener.

Piece(s)	1	500	1000	5000	
EUR	1.48	1.33	1.12	1.04	

Plastic/Polypropylene 50 Unit, Bulk
 Ø 110 mm



05036 Storage box „Banana box 2.0“

Neat keep-fresh box in various colours with space for 1 banana. Ideal for protecting the banana against bruising.

Piece(s)	1	500	1000	5000	
EUR	2.51	2.25	1.90	1.77	

Plastic/Polypropylene 40 Unit, Bulk
 260 mm x 65 mm x 51 mm



SALE!

08827 Storage Box „Kiwi-Box“

For all those who love kiwis! Practical storage box with removable kiwi divider and small spoon. Simply place the fruit in the box and close the box with the divider inserted in the lid. The kiwi is quickly divided into two halves and can then be eaten. To transport the whole fruit, simply remove the divider from the lid, insert the kiwi and reinsert the divider. The box is embossed with „TO GO KIWI“ on the lid.

Piece(s)	1	100	500	1000
EUR	1.42	1.24	1.22	1.19

Plastic/Polypropylene 72 Unit, Polybag
 110 mm x 80 mm x 80 mm



05238 Storage box „Universal box“

„Storage box available in a variety of colour combinations. Microwave-proof up to +120°C freezer-safe down to -20°C. With lid and 2 practical handles.“

Piece(s)	1	100	500	1000	
EUR	2.94	2.63	2.22	2.07	

Plastic/Polypropylene 36 Unit, Bulk
 165 mm x 125 mm x 55 mm



05302 Lunch box „Universal box“ large

Piece(s)	1	100	500	1000	
EUR	7.01	6.27	5.28	4.93	

Plastic/Polypropylene 26 Unit, Bulk
 233 mm x 162 mm x 77 mm



05248 Storage box „Bread box“

Storage box available in a variety of colour combinations. Microwave-proof up to +120°C. With lid and 2 practical handles. Capacity: 1.5 litres.

Piece(s)	1	100	500	1000	
EUR	5.35	4.79	4.03	3.76	

Plastic/Polypropylene 25 Unit, Bulk
 233 mm x 162 mm x 77 mm



01141 Lunchbox „Elite“, small

Small lunchbox with 4-point closing mechanism and silicone seal. The box is perfect for storing foodstuffs of all kinds in the fridge and prevents them from drying out too quickly. It can also be used to warm your dishes in the microwave. It is heat-resistant up to 120°C and can withstand cold temperatures down to 0°C.

Piece(s)	1	100	500	1000
EUR	2.38	2.13	1.80	1.68



Plastic/Polypropylene 100 Unit, Polybag
 170 mm x 105 mm x 50 mm



01101 Round lunch box „Urban“

Carrying your lunch with you is so simple! Round lunchbox with handle with a transparent, screw-on lid with a silicone seal. This makes leaking food a thing of the past. The colourful bottom section of the box is microwave-safe. Capacity: 1.1 litres.



Piece(s)	1	100	500	1000
EUR	6.76	6.05	5.10	4.76

 Plastic/Polypropylene  36 Unit, Polybag
 180 mm x 150 mm x 104 mm



01102 Round lunch box with cutlery „Urban“

Piece(s)	1	100	500	1000
EUR	7.70	6.89	5.81	5.42



 Plastic/Polypropylene  36 Unit, Polybag
 180 mm x 150 mm x 104 mm



01100 Lunch box „Urban“

Plenty of room for lunch on-the-go! Square lunch box with a lid with a ring seal and four hinged clips to prevent the unwanted leakage of the food. The colourful bottom section of the box is microwave-safe. Capacity: 0.76 litre.

Piece(s)	1	100	500	1000
EUR	4.89	4.38	3.69	3.44



 Plastic/Polypropylene  36 Unit, Polybag
 143 mm x 143 mm x 64 mm



01099 Square lunch box „Urban“

For an organised lunch on-the-go! Small lunch box with one large and two small compartments. The lid with a sealing ring and four hinged fastening clips prevents the unwanted leakage of foods and also has a transparent compartment with a knife and fork. The colourful bottom section of the box is microwave-safe. Capacity: 1.3 litres.

Piece(s)	1	50	250	500
EUR	9.46	8.46	7.13	6.65



 Plastic/Polypropylene  24 Unit, Polybag
 222 mm x 164 mm x 77 mm



01098 Cup „Urban“

Hip To-Go cup for soups etc. The large cup has a black screw-on lid with a silicone seal with which to safely seal the cup. The transparent chamber attachment, which also screws on, allows you to transport other foodstuffs, which are not to come into contact with the contents of the cup just yet. The colourful cup is microwave-safe. Cup capacity: 0.42 litre and chamber attachment: 0.13 litre.

Piece(s)	1	100	500	1000
EUR	5.45	4.87	4.11	3.83



 Plastic/Polypropylene
  30 Unit, Polybag
 78 mm x 200 mm x Ø 78 mm



01089 Cup with attachment „Urban“

Practical To-Go cup for muesli, soups etc. The large cup with handle has a black screw-on lid with a silicone seal with which to safely seal the cup. The transparent chamber attachment, which also screws on, allows you to transport other foodstuffs, which are not to come into direct contact with the contents of the cup. The colourful cup is microwave-safe. Cup capacity: 0.52 litre and chamber attachment: 0.23 litre.

Piece(s)	1	100	500	1000
EUR	5.05	4.52	3.81	3.55



 Plastic/Polypropylene
  32 Unit, Polybag
 126 mm x 97 mm x 150 mm



01097 Cup with handle „Urban“

Stylish To-Go cup for soups etc. The large cup with handle has a black screw-on PP lid with a silicone seal with which to safely seal the cup. The colourful cup is microwave-safe. Capacity: 0,52 litre.

Piece(s)	1	100	500	1000
EUR	3.96	3.55	2.99	2.79

 Plastic/Polypropylene
  48 Unit, Polybag
 126 mm x 97 mm x 107 mm

SALE!



09081 Bento box „Mitaka“

A lot of space, including cooling function. Plastic box with two levels, lockable by two click-closure hinges. Including removable cold pack in the intermediate level, fork and spoon and silicone sealing at the lid.

Piece(s)	1	100	500	1000
EUR	5.75	5.15	4.33	4.05

Plastic/PP + PS 36 Unit, Polybag
 200 mm x 135 mm x 95 mm

SALE!



09080 Bento box „Narita“

The best friend for your snack. Great plastic box with two locking hinges, incl. partition wall and integrated small dip bowl. The provided spork finds its place on the lid of this small bowl. The lid of the lunch box offers a silicone ring for better sealing.

Piece(s)	1	100	500	1000
EUR	4.78	4.28	3.60	3.36

Plastic/PP + PS 36 Unit, Polybag
 230 mm x 150 mm x 75 mm



08457 Lunch box „Metallic“

Fantastic aluminium snack box with clamps for secure closure. The lid can be completely removed. Available in matt and shiny.

Piece(s)	1	50	250	500
EUR	15.00	14.00	12.69	11.84



Metal/Aluminium 24 Unit, Paper sleeve
 180 mm x 120 mm x 55 mm



08456 Lunch box „Aluminium“

Robust. Fantastic aluminium snack box with clamps for secure closure. The lid can be completely removed. Available in matt and shiny.

Piece(s)	1	50	250	500
EUR	13.00	12.28	11.41	10.65



 Metal/Aluminium
 180 mm x 117 mm x 60 mm

 24 Unit, Paper sleeve



01123 Lunch box „Aluminium“, large

Piece(s)	1	25	100	250
EUR	17.15	16.29	15.37	14.34

 Metal/Aluminium
 240 mm x 140 mm x 70 mm



 12 Unit, Paper sleeve



01382 Lunch box „Quadrado“, small

Small, square snack box made from aluminium, with a matte finish. Fastens securely by means of a pair of clamp fasteners. The lid can be completely removed. Not just for use on building sites.



Piece(s)	1	50	250	500
EUR	15.00	14.66	12.89	12.03

 Metal/Aluminium
 175 mm x 175 mm x 50 mm

 24 Unit, Paper sleeve

01381 Lunch box „Quadrado“, large

Piece(s)	1	25	100	250
EUR	19.59	18.15	16.69	15.57

 Metal/Aluminium
 230 mm x 230 mm x 65 mm

 16 Unit, Paper sleeve



01647 Storage container „Apart“ 17x13x6 cm

Ideal for lunch or for a snack between meals. The stainless steel storage container can be used time and again, which makes it a perfect environmentally friendly alternative to aluminium foil and cling film. The securely welded compartments inside the box - visible at the weld points on the underside of the box - keep various foods safely separated. It features a sealing ring and sturdy clamps at the sides. Not suitable for liquid foods.

Piece(s)	1	50	250	500
EUR	13.84	12.81	12.02	11.21

Metal/Stainless steel 16 Unit, Individual carton
 170 mm x 130 mm x 60 mm

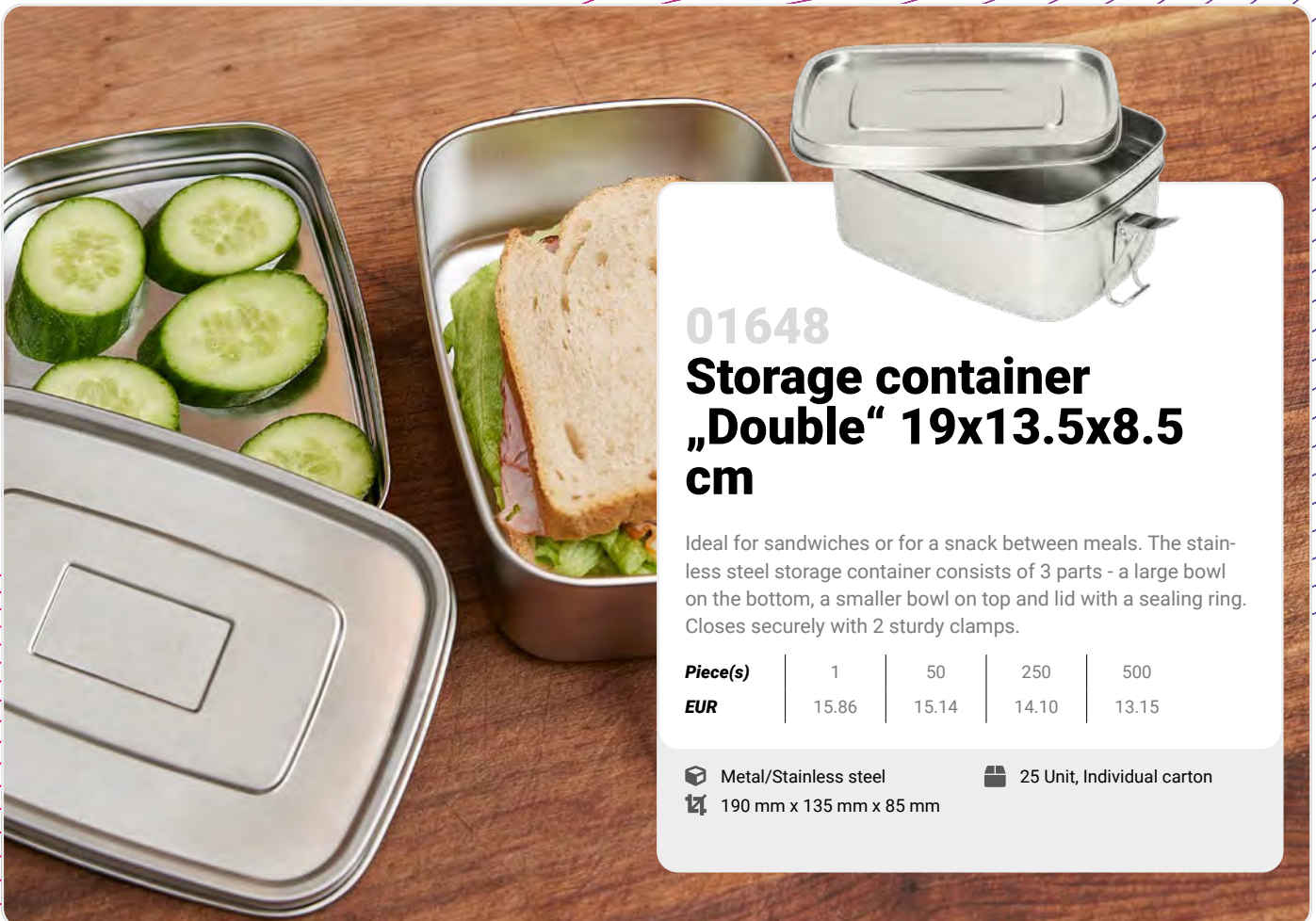

01648 Storage container „Double“ 19x13.5x8.5 cm

Ideal for sandwiches or for a snack between meals. The stainless steel storage container consists of 3 parts - a large bowl on the bottom, a smaller bowl on top and lid with a sealing ring. Closes securely with 2 sturdy clamps.

Piece(s)	1	50	250	500
EUR	15.86	15.14	14.10	13.15



Metal/Stainless steel 25 Unit, Individual carton
 190 mm x 135 mm x 85 mm



01536 Lunch box „Bamboo“, small

Plastic-free lunch box for your promotion. The container is in aluminium, the lid is made from bamboo and has a silicon ring and clamp to ensure reliable closure. The lid is completely removable and can be used as a chopping board if needed.



Piece(s)	1	50	250	500
EUR	14.29	13.57	12.26	11.44

 Metal/Aluminium  24 Unit, Paper sleeve
 170 mm x 117 mm x 57 mm



01537 Lunch box „Bamboo“, large

Piece(s)	1	50	250	500
EUR	17.43	16.72	15.46	15.29



 Metal/Aluminium  12 Unit, Paper sleeve
 230 mm x 150 mm x 70 mm



01224 Lunchbox „Vesper“

Lovely sandwich box with a bowl made from stainless steel and a bamboo lid. The box is closed by means of a black rubber strap.



Piece(s)	1	50	250	500
EUR	11.43	10.71	9.77	9.11

 Metal/Stainless steel  40 Unit, Paper sleeve
 160 mm x 110 mm x 60 mm



01418 Lunch box „Vesper“, large

Piece(s)	1	25	100	250
EUR	16.00	15.57	13.87	12.94

 Metal/Stainless steel  20 Unit, Paper sleeve
 160 mm x 160 mm x 80 mm



01357 Glass box „Balance“ 17x12,6x5,5 cm

For your next lunch. Lovely box with a base made from high-quality, heat-resistant borosilicate glass. The bamboo lid has a silicone ring, which helps it stay securely on the container. The glass container is suitable for use in the microwave.

Piece(s)	1	50	250	500
EUR	8.74	8.08	7.45	6.95

Glass/Borosilicate 24 Unit, Individual carton + Foil
 170 mm x 125 mm x 60 mm



01649 Glass box „Balance“ 19,5x14,5x6 cm

Piece(s)	1	50	250	500
EUR	10.14	10.00	8.41	7.84

Glass/Borosilicate 16 Unit, Individual carton + Foil
 200 mm x 150 mm x 73 mm



01650 Glass box „Balance“, round 17x7 cm

Lovely round box with a base made from high-quality, heat-resistant borosilicate glass. The bamboo lid has a silicone ring, which helps it stay securely on the container. The glass container is suitable for use in the microwave.

Piece(s)	1	100	500	1000
EUR	7.34	6.79	6.25	5.83

Glass/Borosilicate 12 Unit, Individual carton + Foil
 70 mm x Ø 170 mm



01651 Glass box „Balance“, round 19x7,5 cm

Piece(s)	1	50	250	500
EUR	10.48	9.70	8.93	8.33

Glass/Borosilicate 8 Unit, Individual carton + Foil
 75 mm x Ø 190 mm



NEW!

01713 Glass box „Cerrada“ 17x12.6x5.5 cm

Glass box made of high-quality borosilicate glass with a food grade PP lid and silicone sealing ring. The borosilicate glass bowl is extremely stable, temperature resistant and therefore suitable for refrigerators, dishwashers, microwave ovens and baking ovens. The sealing ring and 4-fold click fastening on the box provide airtight storage of foodstuffs, retaining their freshness for longer. Perfect for storing and transporting food and meals. Safety tip: open all fastenings and remove the lid before you place the glass container in a microwave oven or baking oven.

Piece(s)	1	100	500	1000
EUR	5.62	5.03	4.24	3.95

Glass/Borosilicate
 170 mm x 126 mm x 55 mm

24 Unit, Individual carton + Polybag



01715 with 2 compartments.



01715 Glass box „Cerrada“ with 2 compartments 19.7x14.8x6 cm

Piece(s)	1	50	250	500
EUR	9.27	8.29	6.99	6.52

01714 Glass box „Cerrada“ 19.7x14.8x6 cm

Piece(s)	1	100	500	1000
EUR	8.24	7.38	6.22	5.80

01715
 197 mm x 148 mm x 60 mm
 16 Unit, Individual carton + Polybag

01714
 197 mm x 148 mm x 60 mm
 16 Unit, Individual carton + Polybag



01550 Glass container „Bamboo“, 375 ml

Environmentally-friendly storage container for keeping your kitchen and home tidy. The glass cylinder is made from high-quality borosilicate glass. The lid is in bamboo and has a silicon ring to ensure reliable closure. The large opening allows quick, easy access to stored foods, easy to clean and rinse. Exceptionally suitable for the storage of things like rice, noodles, nuts, flour, tea and spices. Capacity: 375 ml.

Piece(s)	1	100	500	1000
EUR	5.89	5.45	4.99	4.66

Glass/Borosilicate
 110 mm x Ø 70 mm

50 Unit, Individual carton + Bubble wrap



01552 Glass container „Bamboo“, 1.6 l

Piece(s)	1	50	250	500
EUR	11.07	10.25	9.37	8.74

01551 Glass container „Bamboo“, 700 ml

Piece(s)	1	100	500	1000
EUR	7.55	6.99	6.40	5.97

01552
 190 mm x Ø 110 mm
 25 Unit, Individual carton + Bubble wrap

01551
 140 mm x Ø 90 mm
 25 Unit, Individual carton + Bubble wrap



04777 Cereal box „Cereal“

Whether flour, sugar or corn flakes – all of this can be put in this cereal box. Due to the removable lid and the large opening it is much easier to fill and pour out the contents. The curved shape guarantees a comfortable use. Capacity: approx. 2.5 litres

Piece(s)	1	100	500	1000	
EUR	5.03	4.50	3.79	3.54	

Plastic/Polypropylene 15 Unit, Bulk
 218 mm x 110 mm x 215 mm



NEW!

01624 Pouring container „Storage“

Flour, sugar, cornflakes...everything has its own place. Thanks to the rectangular shape of the pouring container, it's easy to keep your shelves tidy and clearly organised. The removable lid makes filling the container easy, and the large opening in the lid allows the contents to be poured. Capacity: approx. 1.6 litres.

Piece(s)	1	100	500	1000
EUR	6.19	5.54	4.67	4.36

Plastic/PP + PS 17 Unit, Bulk
 160 mm x 90 mm x 235 mm



01545 Fresh food cover „Universal“

Keep your food fresh for longer! The fresh food cover can be used universally and fits over a lot of manufacturer's cups. It extends the shelf life of opened food and is free from BPA and harmful plastics. It can also be used for labelling your own food in e.g. Shared fridges.

Piece(s)	1	500	1000	5000	
EUR	0.36	0.32	0.27	0.25	

Plastic/ABS 1000 Unit, Bulk
 95 mm x Ø 95 mm



NEW!

01706 Beeswax cloth „Beeologic“

The sustainable and environmentally-friendly alternative to aluminium foil and cling film! Perfect for wrapping sandwiches, fruit, and vegetables or covering food and liquids in bowls and dishes. During use, through body heat alone, the beeswax cloth forms perfectly around foods, bowls or containers. The heat „welds“ the folded down edges. It can be removed just as easily and can be washed with cold or lukewarm water for re-use. With careful handling, the cloth can be re-used over a long period of time. Not suitable for raw meat and fish.

Piece(s)	1	100	500	1000
EUR	3.15	2.93	2.66	2.48

Textile/Cotton 400 Unit, Ind. carton + Paper packaging
 250 mm x 250 mm



05040 Tray „Profi 240“

Round tray made of break-proof plastic. The bottom and high edges offer useful finishing options.

Piece(s)	1000	5000
EUR	2.85	2.70



Plastic/Polystyrene
33 mm x Ø 247 mm

30 Unit, Bulk



05099 Tray „Profi 320“

Large, round tray with special anti-slip coating. IMould labelling possible.

Piece(s)	500	1000	5000
EUR	7.01	6.69	6.36



Plastic/Polystyrene
45 mm x Ø 320 mm

10 Unit, Bulk



05116 Tray „Gastro-Expert 360“

Large, round tray with special anti-slip coating (on request). IMould labelling possible.

Piece(s)	1	50	250	500
EUR	10.34	9.41	8.25	7.75



Plastic/Polystyrene
30 mm x Ø 360 mm

10 Unit, Bulk



05069 Tray „Gastro-Pro 360“

Large, round plastic tray. Extraordinary stability and easy to clean. Top quality made in Germany. With special anti-slip coating and imould finish. A print on the bottom part is also possible.

Piece(s)	1	100	500	1000
EUR	7.95	7.48	7.01	6.69



Plastic/Polystyrene
30 mm x Ø 370 mm

10 Unit, Bulk



05041 Tray „Bistro“

Oval tray made of stable plastic with large advertising space and with a low edge for better handling. Perfectly suited for serving coffee or tea.

Piece(s)	1	100	500	1000	
EUR	2.94	2.63	2.21	2.07	

Plastic/Polystyrene 30 Unit, Bulk
 319 mm x 244 mm x 11 mm



05049 Tray „Maxi-heart“

Large heart-shaped serving tray. Available in a large selection of colours. For those romantic moments and more.

Piece(s)	1	100	500	1000	
EUR	3.10	2.78	2.34	2.18	

Plastic/Polystyrene 45 Unit, Bulk
 270 mm x 315 mm x 20 mm



05042 Tray „Service“

With 2 handles for convenient carrying and an ultra-brilliant IMould label in photo quality.

Piece(s)	1	100	500	1000	
EUR	3.96	3.54	2.98	2.78	

Plastic/Polypropylene 40 Unit, Bulk
 314 mm x 296 mm x 37 mm



01219 Tray round, medium

For all professional caterers. Round tray made from PP with a non-slip rubber coating. So all the glasses stay where they should.

Piece(s)	1	100	500	1000
EUR	4.85	4.34	3.66	3.41

Plastic/Polypropylene 12 Unit, Polybag
 20 mm x Ø 355 mm



05043 Tray „Beer crate“

Fits any standard beer crate. Ideal as a give-away with a crate. IMould labelling possible.

Piece(s)	1	100	500	1000	
EUR	4.00	3.58	3.02	2.82	

Plastic/Polystyrene 25 Unit, Bulk
 370 mm x 255 mm x 16 mm



05229 Chopping board „Snack“

Practical chopping board with hole for hanging. Ideal for snacks. IMould labelling possible.

Piece(s)	1	100	500	1000	
EUR	3.12	2.79	2.35	2.19	

Plastic/Polystyrene 75 Unit, Bulk
 227 mm x 147 mm x 5 mm



05286 Cutting board „Plus“

Handy board with a large cutting area and a sap groove against drippy liquids. The two converging sidewalls form a funnel and therefore simplify the addition of ingredients to the pot or the pan.

Piece(s)	1	100	500	1000
EUR	10.60	9.49	7.99	7.46

Plastic/SAN 25 Unit, Bulk
 405 mm x 280 mm x 30 mm



05284 Chopping board „Universal“

Practical cutting board made of sturdy plastic with juice rim and rounded corners. Ideal for cutting and for a small snack. IMould finishing is possible.

Piece(s)	1	500	1000	5000	
EUR	2.67	2.37	1.89	1.76	

Plastic/Polystyrene 70 Unit, Polybag
 220 mm x 140 mm x 4 mm



05228 Chopping board „Sandwich“

Practically sized chopping board with hole for hanging. For snacks. IMould labelling possible.

Piece(s)	1	100	500	1000	
EUR	2.23	1.99	1.68	1.56	

Plastic/Polystyrene 150 Unit, Bulk
 175 mm x 115 mm x 4 mm



05264 Chopping board „Lunch“

Chopping board made of plastic with smooth surface and juice rim. In addition, with finger hole for better hold and for hanging up.

Piece(s)	1	100	500	1000	
EUR	3.57	3.19	2.69	2.51	

Plastic/Polystyrene 40 Unit, Bulk
 246 mm x 143 mm x 6 mm



01239 Chopping board „Acacia“

Sturdy chopping board made from acacia wood that has been treated with soybean oil. Incl. grooved juice rim and 2 lateral grip indentations. This item is made from a natural product so may vary in colour and appearance.

Piece(s)	1	100	500	1000
EUR	9.28	8.31	6.53	6.31



Wood/Acacia wood 10 Unit, Polybag
 260 mm x 185 mm x 20 mm



08361 Chopping board „Bamboo“ small

The smallest of the bunch. Smooth cutting board made from 10 mm thick bamboo in 2 different colours. This kitchen utensil has rounded edges and its peculiarity lies in the different fibre directions of the three parts.

Piece(s)	1	100	500	1000
EUR	3.03	2.71	2.28	2.13

 Wood/Bamboo
 230 mm x 150 mm x 9 mm



 50 Unit, Polybag



08062 Chopping board „Bamboo“ large

Piece(s)	1	100	500	1000
EUR	6.22	5.56	4.55	4.24

08360 Chopping board „Bamboo“ medium

Piece(s)	1	100	500	1000
EUR	3.33	2.98	2.51	2.34

08062
 300 mm x 200 mm x 12 mm
 20 Unit, Polybag



08360
 260 mm x 170 mm x 10 mm
 50 Unit, Polybag



01547 Chopping board „Natural“, bamboo

Premium chopping board in naturally antibacterial bamboo. Professional, durable and resistant. Also environmentally-friendly, as bamboo counts as a fast-regrowing raw material. One highlight is the clever design with angled edges that makes it easy to lift the board off the table. Perfectly suitable for both professional and gourmet cooks.

Piece(s)	1	50	250	500
EUR	13.58	12.16	10.24	9.56

 Wood/Bamboo
 500 mm x 300 mm x 20 mm

 5 Unit, Paper sleeve

NEW!

01818 Chopping board „Bamboo“, 24.5x17.5 cm

High-quality chopping board: The all-round talent for the kitchen with a thickness of 8 mm is made of bamboo, which is not only knife-friendly and robust, but also offers clear advantages from an ecological point of view. Bamboo is a rapidly renewable raw material and is therefore absolutely on trend. The practical grip hole makes handling child's play. When not in use, the wooden board can always be stored ready to hand. As with all wooden boards, cleaning by hand is recommended.

Piece(s)	1	100	500	1000
EUR	3.08	2.75	2.32	2.16

Wood/Bamboo
245 mm x 175 mm

48 Unit, Bulk



01819 Chopping board „Bamboo“, 32x30 cm

Piece(s)	1	100	500	1000
EUR	5.22	4.67	3.94	3.67

Wood/Bamboo
320 mm x 200 mm

36 Unit, Bulk

NEW!

01816 Chopping board „Bamboo“, rectangle, 24.5x17.5 cm

High-quality cutting board made of bamboo wood - perfect for the next snack. 15 mm thick, with rounded corners and a juice groove on the edge to prevent liquids from running down. Bamboo wood is not only knife-friendly and robust, but also offers clear advantages from an ecological point of view. It is a rapidly renewable raw material and is therefore absolutely on trend. As with all wooden boards, cleaning by hand is recommended.

Piece(s)	1	100	500	1000
EUR	5.37	4.81	4.05	3.78

Wood/Bamboo
245 mm x 175 mm

24 Unit, Bulk



01817 Chopping board „Bamboo“, rectangle, 32x20 cm

Piece(s)	1	100	500	1000
EUR	6.76	6.05	5.10	4.75

Wood/Bamboo
320 mm x 200 mm

12 Unit, Bulk



08363 Cutting board „Woody“ square, medium

Piece(s)	1	100	500	1000
EUR	6.20	5.55	4.67	4.36

Wood/Beech wood
 24 Unit, Bulk
 300 mm x 200 mm x 15 mm



08366 Cutting board „Woody“ square, large

Piece(s)	1	50	250	500
EUR	10.20	9.13	7.69	7.18

Wood/Beech wood
 12 Unit, Bulk
 400 mm x 300 mm x 15 mm



06741 Chopping board „Woody“ with handle

Piece(s)	1	100	500	1000
EUR	4.06	3.64	3.06	2.86

Wood/Beech wood
 50 Unit, Bulk
 350 mm x 160 mm x 8 mm



06739 Chopping board „Woody“ rectangular

Piece(s)	1	100	500	1000
EUR	3.53	3.16	2.66	2.49

Wood/Beech wood
 50 Unit, Bulk
 220 mm x 147 mm x 15 mm



06740 Chopping board „Woody“ round

Piece(s)	1	100	500	1000
EUR	4.98	4.46	3.75	3.50

Wood/Beech wood
 50 Unit, Bulk
 13 mm x Ø 230 mm



08362 Cutting board „Woody“ wave

Piece(s)	1	500	1000	5000
EUR	1.62	1.45	1.22	1.14

Wood/Beech wood
 50 Unit, Bulk
 210 mm x 111 mm x 8 mm



08743 Cutting board „Woody“ heart

Piece(s)	1	100	500	1000
EUR	7.34	6.57	5.54	5.17

Wood/Beech wood
 45 Unit, Bulk
 280 mm x 280 mm x 10 mm





SALE!



08553 Serving plate „Slate“ medium

A noble piece for serving small delicacies. Elegant serving plate made from natural slate with authentic break lines and four little feet in soft EVA against scratches on the table surface. Ideal for chocolates or a small cheese selection. Incl. coating against water stains and for better cleaning.

Piece(s)	1	100	500	1000
EUR	3.16	2.82	2.37	2.22



 Stone/Slate
 200 mm x 100 mm x 5 mm

 25 Unit, Individual carton + Bubble wrap



01129 Serving platter „Slate“ XXL

Piece(s)	1	50	250	500
EUR	11.04	9.88	8.32	7.77

 Stone/Slate
 400 mm x 300 mm x 5 mm

 10 Unit, Individual carton + Bubble wrap



SALE!



08792 Serving plate „Slate“ rectangle

Noble serving plate made from natural slate with authentic break lines and four little feet in soft EVA against scratches on the table surface. Incl. Glossy coating on the top and bottom against water stains and for easier cleaning.

Piece(s)	1	100	500	1000
EUR	2.57	2.30	1.94	1.82



 Stone/Slate  30 Unit, Individual carton + Bubble wrap
 115 mm x 175 mm x 5 mm



01130 serving platter „Slate“ round, large

Large serving platter made of natural slate with authentic broken edges and feet made of soft EVA, to prevent slipping and the scratching of the tabletop. Incl. shiny coating to prevent water marks and for easier cleaning. Because it is a natural product, each item is unique in its appearance and grain.

Piece(s)	1	100	500	1000
EUR	8.18	7.32	6.17	5.75

 Stone/Slate  10 Unit, Individual carton + Bubble wrap
 5 mm x Ø 300 mm

01200 Tiered cake stand „Slate“

Showcase your 2-tiered presentation stand (diameter: 30cm lower tier/25 cm top tier) made of natural slate with authentic broken edges and feet made of soft EVA to prevent slipping and the scratching of the tabletop. Incl. shiny coating to prevent water marks and for easier cleaning. Because it is a natural product, each item is unique in its appearance and grain.

Piece(s)	1	50	250	500
EUR	15.17	13.58	11.44	10.67

 Stone/Slate  10 Unit, Individual carton + Bubble wrap
 235 mm x Ø 300 mm



SALE!

09467 Spice Mill „Spice“

Elegant spice mill with transparent lid for grinding coarse-grained spices such as pepper, salt or chillies. The robust ceramic grinder is infinitely adjustable and allows different degrees of grinding. The large opening makes it easy to fill the glass container. The hourglass shape and the handy grinding mechanism housing allow easy handling.

Piece(s)	1	100	500	1000
EUR	3.15	2.82	2.37	2.22

Glass

135 mm x Ø 65 mm

50 Unit, Individual carton + Bubble wrap



SALE!

09463 Salt and Pepper Shaker „Flavour“

Small set of salt and pepper shakers with plastic (PS) holder. The shakers have holes of different sizes to easily control salt and pepper shaking. Both parts of the shaker are easily connected by a bayonet closure.

Piece(s)	1	500	1000	5000
EUR	0.52	0.47	0.40	0.37

Plastic/Polystyrene

95 mm x 54 mm x 25 mm

400 Unit, Polybag



01297 Salt and pepper set „Duo“

Elegant set consisting of one salt and one pepper shaker. The shakers are made from birch and have a durable ceramic grinding mechanism. They can be taken apart and refilled.

Piece(s)	1	25	100	250
EUR	22.38	20.03	16.88	15.75

Wood/Birch wood

50 mm x 190 mm

24 Unit, Individual carton



NEW!

01874 Salt and pepper set „Dispense“

The modern salt and pepper shaker set made of soda lime glass looks great on every dining table. The stainless steel lids which unscrew allow the set to be filled and reused multiple times. Several holes in the lids make dispensing easy.

Piece(s)	1	100	500	1000
EUR	4.61	4.12	3.47	3.24

Glass/Soda Lime

40 mm x 40 mm x 90 mm

50 Unit, Individual carton



08596 Mallet „Timber“

One of the most typical kitchen utensils. Stable mallet completely made from beech wood. 32 spikes that can treat any kind of meat.

Piece(s)	1	500	1000
EUR	1.44	1.27	1.06

Wood/Beech wood
 50 Unit, Bulk
 302 mm x 44 mm x 78 mm



01094 Spatula „Madera“

Handy spatula with rounded front edge and opening on handle for hanging up. Made entirely of beech wood. Since the article is made of natural materials, actual colouring and grain may differ from product to product. Wash by hand only.

Piece(s)	1	500	1000
EUR	0.97	0.87	0.73

Wood/Beech wood
 1000 Unit, Bulk
 280 mm x 55 mm x 4 mm



01095 Cooking spoon „Madera“

The perfect aid for every kitchen! Robust beech wood cooking spoon with depression on the spoon front. Since the article is made of natural materials, actual colouring and grain may differ from product to product. Wash by hand only.

Piece(s)	1	500	1000	5000
EUR	1.31	1.18	0.99	0.92

Wood/Beech wood
 625 Unit, Bulk
 300 mm x 53 mm x 13 mm



01092 Rolling pin „Madera“, large

The perfect kitchen aid! Large rolling pin made of beech wood, ideal for precision rolling all types of dough. The rolling pin turns easily on its own axis, lessening fatigue when baking. Since the article is made of natural materials, actual colouring and grain may differ from product to product. Wash by hand only.

Piece(s)	1	100	500	1000
EUR	3.71	3.32	2.80	2.61

Wood/Beech wood
 50 Unit, Bulk
 390 mm x Ø 60 mm



04421 Cookie stamp „Candy Cane“

High-quality stamp made from PP with candy cane design, genuinely made in Germany. Just press the stamp onto the dough by hand so that the cookie obtains its nice decoration. The stamp can easily be removed by the flap on its side. Easy to clean and reusable.

Piece(s)	1	500	1000	5000
EUR	0.59	0.52	0.44	0.41

Plastic/Polypropylene
 3 mm x Ø 67 mm

2500 Unit, Bulk



04423 Set containing 3 biscuit stamps with different motifs.

04423 Cookie stamp set „Cute“

Piece(s)	1	500	1000	5000
EUR	1.10	0.98	0.83	0.77

04420 Cookie stamp „Snowflake“

Piece(s)	1	500	1000	5000
EUR	0.59	0.52	0.44	0.41

04422 Cookie stamp „Snowflake“

Piece(s)	1	500	1000	5000
EUR	0.59	0.52	0.44	0.41

04420
 3 mm x Ø 67 mm
 2500 Unit, Bulk

04422
 3 mm x Ø 67 mm
 2500 Unit, Bulk



04775 Pastry brush „Little Bakery“

Ideal for brushing steaks with self-made marinades or for greasing baking pans. The handy pastry brush featuring a ABS handle and a silicone brush tip is hygienic and easy to clean.

Piece(s)	1	500	1000	5000
EUR	1.53	1.37	1.15	1.07

Plastic/ABS
 150 mm x 40 mm x 11 mm

800 Unit, Bulk



04776 Dough scraper „Little Bakery“

Small and handy helper for any kitchen. The firm handle is made of ABS, the scraper is soft and flexible. The dough scraper is perfectly suitable for removing the last remaining bit of dough even from small bowls.

Piece(s)	1	500	1000	5000
EUR	1.26	1.13	0.95	0.89

Plastic/Polypropylene
 150 mm x 45 mm x 10 mm

400 Unit, Bulk

04116 Pastry cutter „Moon“

Piece(s)	1	500	1000	5000
EUR	0.43	0.38	0.32	0.30

Plastic/Polypropylene 2000 Unit, Bulk
53 mm x 34 mm x 15 mm



04118 Pastry cutter „Heart“

Piece(s)	1	500	1000	5000
EUR	0.42	0.37	0.31	0.29

Plastic/Polypropylene 1700 Unit, Bulk
55 mm x 55 mm x 15 mm



04117 Pastry cutter „Star“

Piece(s)	1	500	1000	5000
EUR	0.43	0.38	0.32	0.30

Plastic/Polypropylene 1700 Unit, Bulk
15 mm x Ø 60 mm



04119 Pastry cutter set „Sweet“

Into the bakery. Traditional pastry cutters made from food-safe plastic in the shape of a heart, a star and the moon in one set. Thanks to their flattened top side these pastry cutters guarantee easy and pleasant working.

Piece(s)	1	500	1000	5000
EUR	1.00	0.90	0.76	0.71

Plastic/Polypropylene 250 Unit, Polybag
165 mm x 100 mm x 15 mm



04122 Pastry cutter set „Sweet“ with box

Piece(s)	1	500	1000	5000
EUR	1.71	1.53	1.29	1.20

Plastic/Polypropylene 100 Unit, Bulk
40 mm x Ø 105 mm



01546 Baking Kit „Kids“

Piece(s)	1	100	500	1000
EUR	6.08	5.44	4.58	4.27

Plastic/Polypropylene 40 Unit, Bulk
190 mm x 139 mm x 70 mm



04897 Plastic knife „Bakery“

The streamlined one among the kitchen knives. Great kitchen accessory in one piece with serrated blade and ergonomic handle. Completely made of plastic and with hole at the end of the handle.

Piece(s)	1	500	1000	5000	
EUR	1.36	1.22	1.03	0.96	

Plastic/Polypropylene 140 Unit, Bulk
 282 mm x 57 mm x 10 mm



SALE!

09358 Pizza Slicer „Piece“

Pizza slicer with a round, sharp stainless steel blade and an ABS casing. The blade with a diameter of 7.3 cm cuts easily through thick toppings. The blade and housing are separable and therefore easy to clean. Incl. attachable cardboard blade protector.

Piece(s)	1	100	500	1000
EUR	1.83	1.63	1.37	1.29

Metal/Stainless steel 250 Unit, Polybag
 97 mm x 73 mm x 20 mm



01238 Folding knife „Lunchtime“

Light folding knife with an ABS handle and sharp ceramic blade. The knife can be folded, so it's safe to transport and store.

Piece(s)	1	100	500	1000
EUR	4.32	3.86	3.26	3.04

Ceramic 500 Unit, Individual carton + Polybag
 190 mm x 25 mm



06952 Apple splitter „Split ,n' eat“

The easiest way to cut apples. Apple-shaped plastic apple splitter with metal blade. Simply place it on the apple, push down forcefully, and enjoy!

Piece(s)	1	100	500	1000
EUR	2.40	2.15	1.81	1.69

Plastic/ABS 168 Unit, Polybag
 160 mm x 140 mm x 13 mm x Ø 95 mm

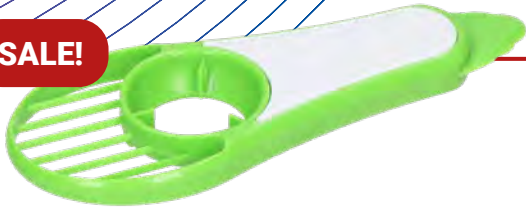

SALE!



01015 Avocado Peeler „Peel“

Cut, remove the pit, release the pulp, this practical avocado peeler makes it all easy to do. With large advertising space on the handle.

Piece(s)	1	500	1000	5000
EUR	1.37	1.23	1.04	0.97



 Plastic/ABS  200 Unit, Polybag
 169 mm x 65 mm x 15 mm



01417 Cutlery set „Bamboo“

Environmentally friendly reusable cutlery, replacing any type of plastic cutlery. The set consists of a knife, fork and spoon made of bamboo, plus a useful cotton bag. Every individual piece of cutlery is naturally anti-bacterial. They may differ in colour, shape and diameter. Simple to use & clean, versatile and reusable, free of plastic, biodegradable, eco-friendly and anti-bacterial.

Piece(s)	1	100	500	1000
EUR	2.26	2.02	1.70	1.59

 Wood/Bamboo  200 Unit, Cotton pouch
 225 mm x 70 mm



01036 Cutlery set „To Go“

Perfect for camping, picnics or the lunch break: 3-piece cutlery set with stainless steel spoon, fork and knife. Compactly packed in a synthetic rubber bag with zip.

Piece(s)	1	100	500	1000
EUR	3.56	3.28	2.94	2.74



 Metal/Stainless steel  150 Unit, Nylon-etui + Polybag
 200 mm x 65 mm x 15 mm



01103 Cutlery set „Urban“

Practical cutlery set consisting of a spoon and fork with extendable handles. The set can be securely stored in a transparent PP box without taking up too much space, and can thus be used any time, anywhere.

Piece(s)	1	100	500	1000
EUR	2.72	2.44	2.05	1.92

 Plastic/Polypropylene  100 Unit, Polybag
 108 mm x 46 mm x 35 mm



05294 Cutlery „Spork“

Fork or spoon? It's just both. Practical piece of cutlery made of plastic, to be used as a spoon and as a fork.

Piece(s)	1	500	1000	5000	
EUR	0.28	0.25	0.21	0.19	

Plastic/Polypropylene 1000 Unit, Bulk
 133 mm x 31 mm



15646 Eco-Spoon

Perfect for coffee, muesli and much more. Durable teaspoon with rounded edges. Made of organic plastic and available in many beautiful natural colours.

Piece(s)	1	500	1000	5000	
EUR	0.39	0.35	0.30	0.28	

Plastic/Bio-based plastic 1000 Unit, Bulk
 145 mm x 31 mm



05646 Spoon „Plastic“

Durable plastic spoon with rounded edges. Available in many different colours.

Piece(s)	1	500	1000	5000	
EUR	0.31	0.27	0.23	0.22	

Plastic/Polypropylene 1000 Unit, Bulk
 145 mm x 31 mm x 7 mm



01841 Spoon „Starter“

Perfect for coffee, muesli and co. Durable plastic teaspoon with rounded edges. The handle is perfect for full-surface digital printing.

Piece(s)	1	500	1000	5000	
EUR	0.53	0.48	0.40	0.37	

Plastic/ABS
 135 mm x 15 mm

500 Unit, Bulk

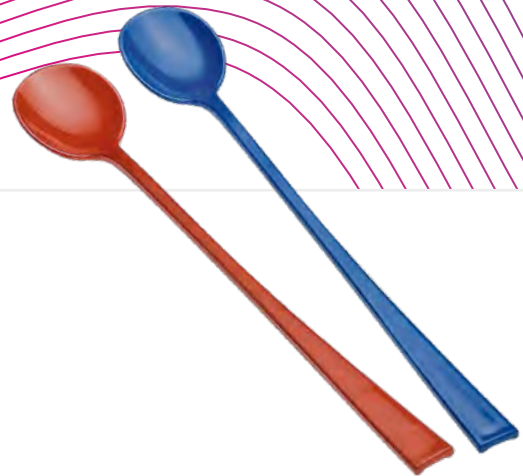

05063 Spoon „long handle“

Universally usable long-handled spoon made of food-safe plastic. Perfect for ice-cream or latte macchiato.

Piece(s)	1	500	1000	5000	
EUR	0.37	0.33	0.28	0.26	

Plastic/SAN
 190 mm x 29 mm x 6 mm

1000 Unit, Bulk



05064 Spoon „Coffee portion“

Practical spoon for perfect measuring of the right quantity of coffee powder. Capacity: 6 - 7g.

Piece(s)	1	500	1000	5000	
EUR	0.26	0.24	0.20	0.18	

Plastic/Polypropylene
 108 mm x 36 mm x 23 mm

1000 Unit, Bulk



NEW!

01839 Chopsticks, set of 2

No more single-use chopsticks for takeaway dishes! Our new chopsticks reduce unnecessary waste generation. The sustainable alternative to single-use tableware. Reusable, up to 100% recyclable and, of course, BPA-free. Suitable for dishwashers, making them perfect for private use and in catering.

Piece(s)	1	500	1000	5000	
EUR	1.00	0.90	0.76	0.71	

Plastic/Polystyrene
 251 mm x 5 mm

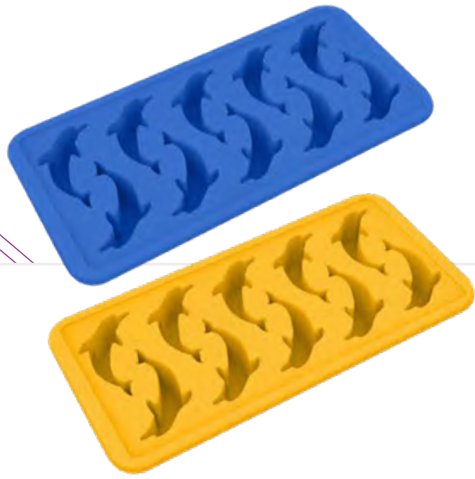

05027 Ice cube mould „Dolphins“

Flexible mould for 10 ice cubes, shaped like a dolphin. The soft material makes it really ease to extract the ice cubes when frozen.

Piece(s)	1	500	1000	5000	
EUR	2.51	2.25	1.89	1.77	

Plastic/TPE Thermoplast Elastomer
 100 Unit, Bulk
 220 mm x 105 mm x 16 mm

05028 Ice cube mould „Penguins“

Piece(s)	1	500	1000	5000	
EUR	2.51	2.25	1.89	1.77	

Plastic/TPE Thermoplast Elastomer
 100 Unit, Bulk
 220 mm x 105 mm x 17 mm

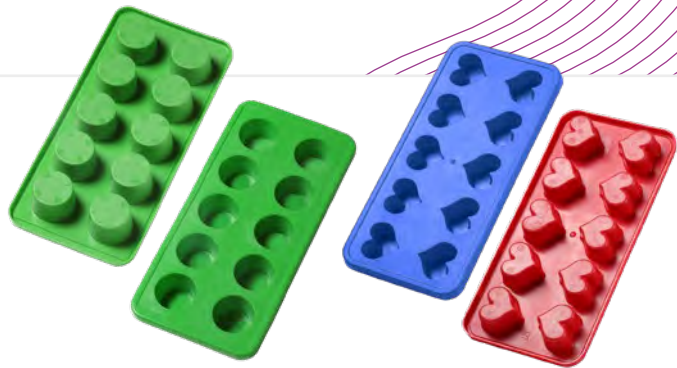

05026 Ice cube mould „Squares“

Flexible mould for 10 ice cubes. The soft material makes it really ease to extract the ice cubes when frozen.

Piece(s)	1	500	1000	5000	
EUR	2.64	2.36	1.99	1.86	

Plastic/TPE Thermoplast Elastomer
 100 Unit, Bulk
 220 mm x 105 mm x 22 mm

05029 Ice cube mould „Hearts“

Piece(s)	1	500	1000	5000	
EUR	2.79	2.50	2.11	1.97	

05030 Ice cube tray „Round“

Piece(s)	1	500	1000	5000	
EUR	2.82	2.53	2.13	1.99	

05029
 220 mm x 105 mm x 20 mm
 100 Unit, Bulk

05030
 220 mm x 105 mm x 16 mm
 100 Unit, Bulk



SALE!

09164 Cooling cuff „Cork“, small

Cool on the way. Useful cooling cuff with flexible cork on the outside and six individual cooling chambers on the inside. Just put into the refrigerator compartment for cooling. The gel chambers adapt perfectly to the bottle shape even when in cold state. The large hook-and-loop fastener guarantees safe hold. Suitable for bottles of up to 0.5 litres and always reusable.

Piece(s)	1	100	500	1000
EUR	2.07	1.84	1.56	1.46

Wood/Cork
 100 Unit, Polybag
 300 mm x 110 mm x 10 mm



09292 Cooling cuff „Style“

Cool and stylish. Stylish cooling cuff made from polyester with two cooling pads which are connected by an elastic cord. Suitable for any wine bottle.

Piece(s)	1	100	500	1000
EUR	7.45	6.67	5.62	5.24

Textile/Polyester
 50 Unit, Polybag
 235 mm x 160 mm x 15 mm



05423 Cooling pack „Freeze“

Ideal for hot days. Plastic flat cooling accumulator filled with a special liquid, which fits our storage can „Schoolbox“ (05236) exactly. Just place in the freezer before use for several hours and then place it on the floor of the box. That way, every snack remains fresh for a longer period. Can be used again and again.

Piece(s)	1	500	1000	5000
EUR	1.90	1.71	1.44	1.34

Plastic/Polyethylene
 58 Unit, Bulk
 142 mm x 100 mm x 12 mm



05254 Ice bucket „Vince“

Elegant ice bucket consisting of robust plastic with practical grip slot. Capacity: 2.5 litres.

Piece(s)	1	100	500	1000
EUR	7.80	6.98	5.88	5.49

Plastic/Polypropylene
 12 Unit, Polybag
 226 mm x Ø 175 mm



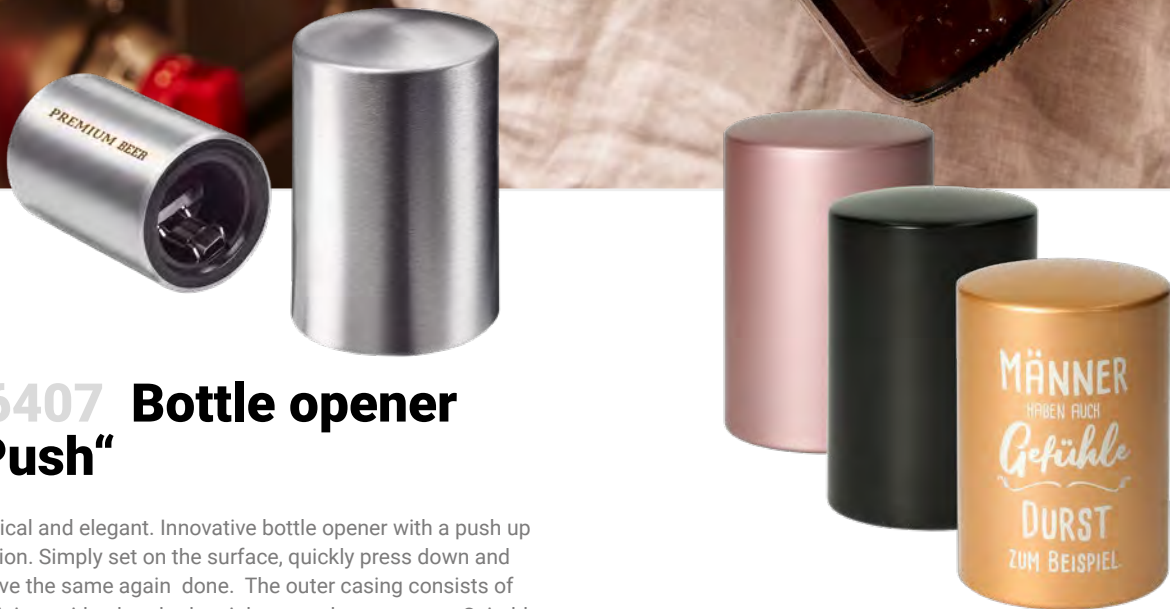



06407 Bottle opener „Push“

Practical and elegant. Innovative bottle opener with a push up function. Simply set on the surface, quickly press down and remove the same again done. The outer casing consists of aluminium with a brushed stainless steel appearance. Suitable for using on all bottles with common caps.



Piece(s)	1	100	500	1000
EUR	3.42	3.13	2.95	2.76

 Metal/Aluminium
 80 mm x Ø 53 mm

 100 Unit, Individual carton + Polybag

01374 Bottle opener „Push“ colour

Piece(s)	1	100	500	1000
EUR	4.49	4.02	3.38	3.16

 Metal/Aluminium
 78 mm x Ø 53 mm

 100 Unit, Individual carton + Polybag

 Decoration

SALE!

01288 Bottle opener „Football“

Innovative bottle opener with push-up function in the shape of a football. Just put it on the bottle, press down swiftly and remove - ready. The external casing is made from ABS. The inner material is sturdy, durable iron. Suitable for all bottles with standard crown caps.

Piece(s)	1	100	500	1000
EUR	3.43	3.07	2.59	2.42

Plastic/ABS
70 mm x Ø 70 mm

100 Unit, Individual carton + Polybag
Decoration

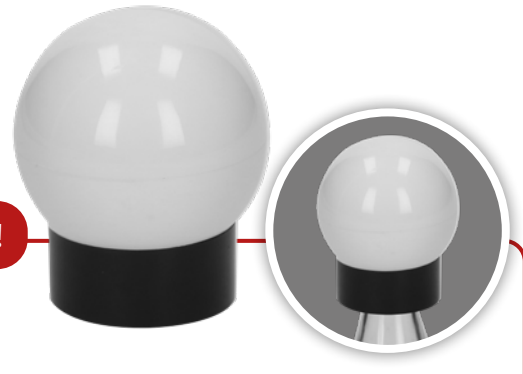
SALE!

01289 Bottle opener „Globe“

Innovative bottle opener with push-up function in the shape of a sphere. Just put it on the bottle, press down swiftly and remove - ready. The external casing is made from ABS. The inner material is sturdy, durable iron. Suitable for all bottles with standard crown caps.

Piece(s)	1	100	500	1000
EUR	3.07	2.76	2.32	2.16

Plastic/ABS
70 mm x Ø 70 mm

100 Unit, Individual carton + Polybag
Decoration



04029 Bottle opener „Police stop“

Round bottle opener with stainless platen and unusual shape.

Piece(s)	1	100	500	1000	
EUR	4.18	3.74	3.15	2.94	

Plastic/ABS
158 mm x 65 mm x 22 mm

200 Unit, Polybag

SALE!

06891 Bottle opener „Cap“

Made of plastic with metal insert. This bottle opener also opens bottles with screw type caps. The magnets allow easy storage on the fridge door for your convenience.

Piece(s)	1	500	1000	5000
EUR	0.96	0.86	0.72	0.67

Plastic/Polystyrene
15 mm x Ø 80 mm

200 Unit, Polybag

SALE!

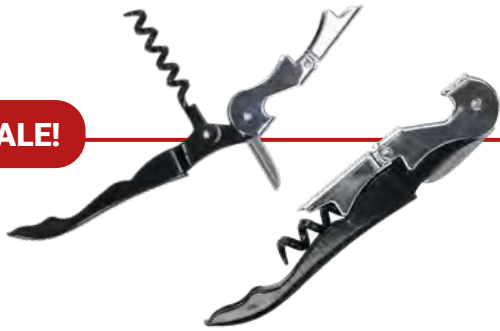



01006 Bottle opener with corkscrew „Corcho“

Elegant corkscrew incl. bottle opener and small, fold-out sommelier knife.

Piece(s)	1	100	500	1000
EUR	1.76	1.57	1.32	1.23

 Metal/Iron

 200 Unit, Polybag

 122 mm x 10 mm x 25 mm





01084 Bottle opener „Salo“

Flat metal bottle opener with zinc alloy. Due to its curved shape it sits particularly comfortably in the hand and has a pleasant feel.

Piece(s)	1	100	500	1000
EUR	3.38	3.02	2.55	2.38

 Metal/Zinc

 200 Unit, Polybag

 120 mm x 35 mm x 3 mm





06341 Bottle opener „Venecia“

Made of aluminium with rubbered grip.

Piece(s)	1	500	1000	5000
EUR	1.67	1.49	1.25	1.17

 Metal/Aluminium

 400 Unit, Individual carton + Polybag

 125 mm x 20 mm x 15 mm





09955 Cap lifter „Casoria“

Flat metal cap lifter of a matt-silver look with elegant curve. Cast in one piece.

Piece(s)	1	100	500	1000
EUR	3.90	3.60	3.22	3.01

 Metal/Zinc

 120 Unit, Individual carton + Polybag



 125 mm x 30 mm x 7 mm



01500 Bottle opener „Flat“

High-quality, flat bottle opener made from stainless steel. Thanks to the material it is made of, it is perfect for embellishing with laser engraving.

Piece(s)	1	500	1000	5000
EUR	0.62	0.56	0.47	0.44



 Metal/Stainless steel
  200 Unit, Polybag
 85 mm x 55 mm



07021 Bottle opener „Speed“

Simple, but effective. Flat bottle opener made of stainless steel. On account of the hole, it is perfectly suited for small spinner shows behind the bar. In addition, it can be attached well to magnetic surfaces.

Piece(s)	1	500	1000	5000
EUR	1.54	1.38	1.16	1.09

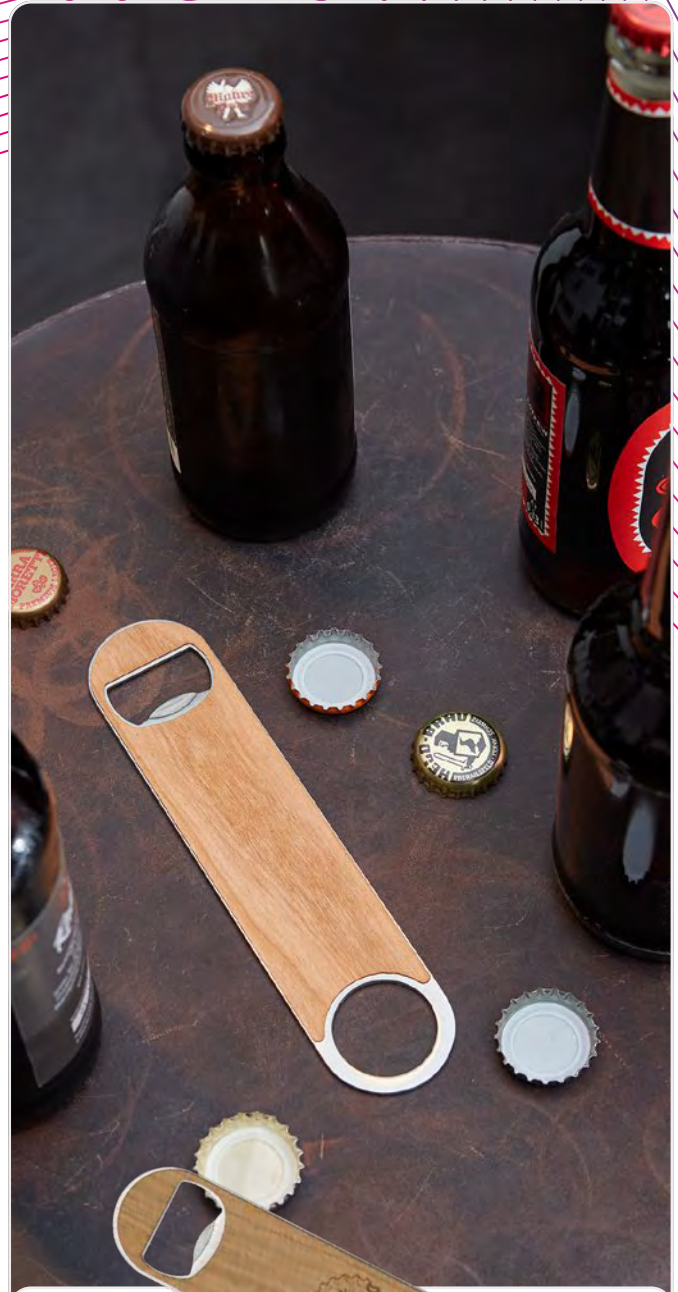

 Metal/Stainless steel
  120 Unit, Polybag
 180 mm x 40 mm x 2 mm



08890 Bottle Opener „Nature“

Flat bottle opener made of stainless steel and wood. The hole makes it perfect for small spinning performances behind the bar. Also easy to attach to magnetic surfaces.

Piece(s)	1	100	500	1000
EUR	2.11	1.89	1.59	1.48



 Metal/Stainless steel
  120 Unit, Polybag
 180 mm x 45 mm x 2 mm



06905 Bottle opener „Woody“

The classic. Robust bottle opener with wooden handle and bottle opener made of stainless steel.

Piece(s)	1	500	1000	5000
EUR	1.79	1.60	1.35	1.26

 Wood/Beech wood
  240 Unit, Polybag
 138 mm x 38 mm x 18 mm





SALE!



01009 Bottle opener „Screw“

Bottle opener in rustical look, made of beech wood with screw to open the bottle. Includes a brown leather strap to hang up the bottle opener.

Piece(s)	1	500	1000	5000
EUR	1.62	1.44	1.22	1.13



 Wood/Beech wood
  400 Unit, Polybag
 150 mm x 20 mm x 20 mm



08460 Cap lifter „Arona“

Elegant and pleasantly lightweight cap lifter with plastic handle (PS) and iron insert for easily opening bottles with crown caps.

Piece(s)	1	500	1000	5000
EUR	0.80	0.72	0.61	0.57

 Plastic/Polystyrene
  400 Unit, Polybag
 148 mm x 47 mm x 10 mm



04207 Bottle opener „Acrylic Transparent“

Transparent bottle opener made of impact resistant acrylic. Advertising either by printing or as paper insert.

Piece(s)	1	500	1000	5000	
EUR	2.43	2.17	1.83	1.71	

Plastic/Acryl 300 Unit, Bulk
 111 mm x 41 mm x 7 mm



04205 Bottle opener „Acrylic Colour“

Unobtrusive bottle opener made of impact resistant acrylic with efficient use of advertising space.

Piece(s)	1	500	1000	5000	
EUR	2.09	1.87	1.58	1.47	

Plastic/Acryl 300 Unit, Bulk
 111 mm x 41 mm x 7 mm



NEW!



01829 Bottle opener „Classic“

2in1: Bottle opener for easy opening and closing of bottles. The opener is made of sturdy iron. The re-capper has curvatures for a secure hold. Ring and back are colour matched. Top side can be fully imprinted with UV digital print.

Piece(s)	1	500	1000	5000
EUR	0.54	0.49	0.41	0.38

Plastic/PP + PS 250 Unit, Individual carton
 92 mm x 41 mm

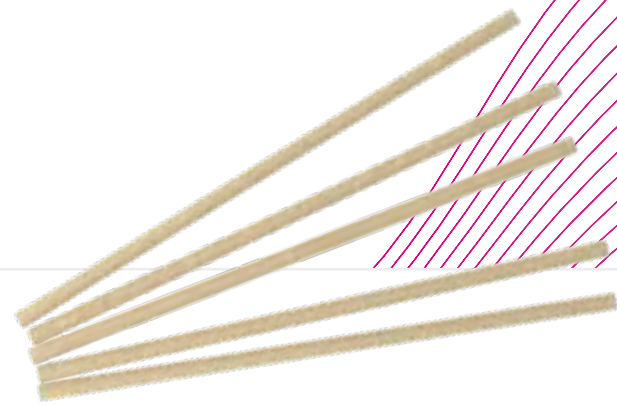

01192 Pack of 100 paper straws "Nature"

The environmentally friendly alternative to plastic straws! Pack of 100 paper straws. The strong kraft paper means the straw can sit in a drink for 24 hours without becoming soft. 100 % biodegradable. Food-safe and neutral in taste. Length: 19.7 cm Diameter: 0.6 cm.

Piece(s)	1	100	500	1000
EUR	2.51	2.25	1.90	1.77

Paper/Cardboard 80 Unit, Individual carton
 197 mm x Ø 5 mm

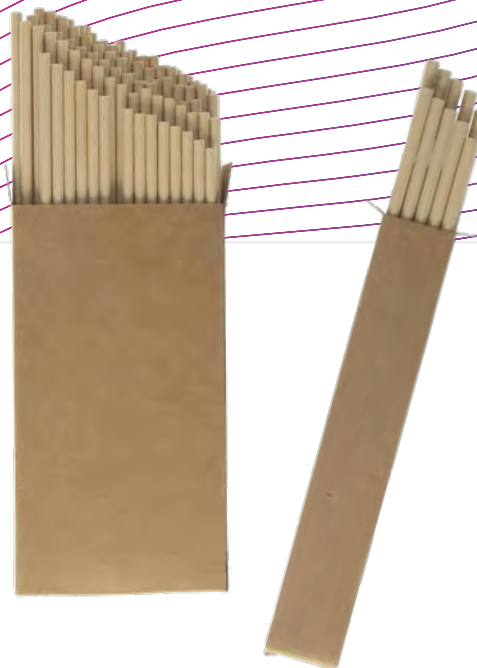

01191 Pack of 10 paper straws „Nature“

Piece(s)	1	500	1000	5000
EUR	0.44	0.39	0.33	0.31

Paper/Cardboard 800 Unit, Individual carton
 197 mm x Ø 6 mm



SALE!

01042 Straw set „Paper“

A natural way to enjoy your drink every day. Set of 10 paper straws. Made of kraft paper, the straw can last longer periods in the drink without becoming soft. Packed in a polybag with a large advertising space on the header card. A natural way to enjoy your drink every day. Set of 10 paper straws. Made of kraft paper, the straw can last longer periods in the drink without becoming soft. Packed in a polybag with a large advertising space on the header card.

Piece(s)	1	500	1000	5000
EUR	0.33	0.30	0.26	0.23

Paper/Cardboard 800 Unit, Polybag
 200 mm x 80 mm x 6 mm



01146 Pack of 11 paper fan straws „German flag“

The environmentally friendly alternative to plastic straws! The pack of 11 paper straws impresses with its perfect look for any fan party. The strong kraft paper means the straw can sit in a drink for 24 hours without becoming soft. 100 % biodegradable. Food-safe and neutral in taste. Length: 19.7 cm Diameter: 0.6 cm.

Piece(s)	1	500	1000	5000
EUR	0.46	0.41	0.34	0.32

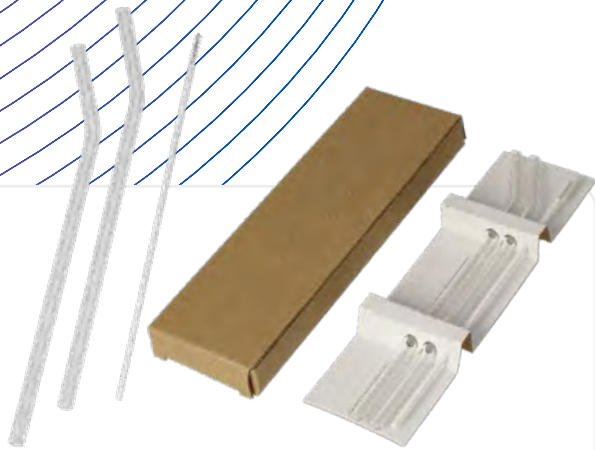

Paper/Cardboard 800 Unit, Individual carton
 197 mm x Ø 5 mm



01207 Straw „Glass“

A stylish alternative to plastic straws! Pack of two curved glass straws and a cleaning brush. Food-safe and neutral in taste. Length: 21.5 cm.

Piece(s)	1	100	500	1000
EUR	2.33	2.09	1.76	1.64



 Glass  100 Unit, Individual carton
 220 mm x 60 mm x 20 mm



01022 Straw set „Steel“

The environmentally friendly alternative to plastic straws. Reusable stainless steel straw set contains 2 pcs of straws with a cleaning brush. Packed in a drawstring cotton bag. Straw Length: approx. 20.5 cm.

Piece(s)	1	100	500	1000
EUR	2.49	2.27	2.01	1.88

 Metal/Stainless steel  250 Unit, Cotton pouch
 230 mm x 67 mm

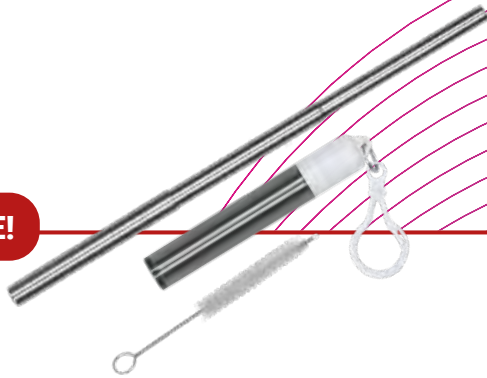

SALE!



01208 Straw „Telescopic“

Practical straw with the WOW-effect! The stainless steel straw extends like a telescope. It can be transported in a screw-top plastic case, which can be attached anywhere using the plastic carabiner hook. A small brush is also included with which the straw can be easily cleaned. Can be re-used any number of times.

Piece(s)	1	100	500	1000
EUR	2.27	2.04	1.72	1.60

 Metal/Stainless steel  500 Unit, Polybag
 150 mm x 15 mm



05012 Cocktail stirrer „Oval“

Millions of cocktails are consumed worldwide every day, but they are very rarely used for advertising purposes. A cocktail stirrer offers the perfect opportunity to draw attention to your brand or product.

Piece(s)	1	500	1000	5000	
EUR	0.27	0.24	0.20	0.19	

Plastic/Polystyrene 1000 Unit, Bulk
 187 mm x 44 mm x 2 mm

07893 Cocktail stirrer „Round“

Millions of cocktails are consumed worldwide every day, but they are very rarely used for advertising purposes. A cocktail stirrer offers the perfect opportunity to draw attention to your brand or product.

Piece(s)	1	500	1000	5000	
EUR	0.32	0.29	0.24	0.23	

Plastic/Polystyrene 1000 Unit, Bulk
 180 mm x 35 mm x 3 mm



09258 Boston Shaker 0.7 l

Two-part boston shaker made of stainless steel and glass for professional use. Volume filled: 0.7 litres.

Piece(s)	1	50	250	500
EUR	15.98	14.30	12.05	11.24

Metal/Stainless steel 25 Unit, Individual carton + Polybag
 170 mm x Ø 91 mm



09051 Sweet dispenser

With removable lid for easy filling. Suitable for chocolates, chewing gum, sweets and more.

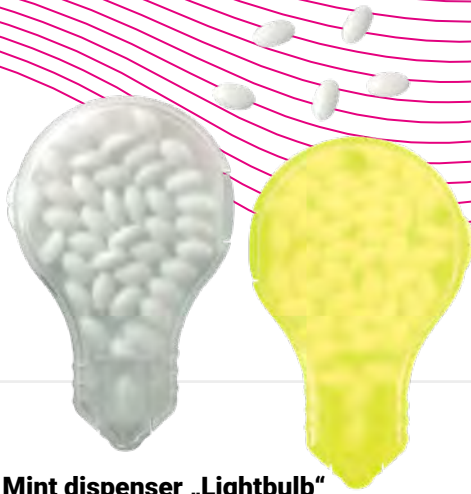

Piece(s)	1	100	500	1000	
EUR	6.28	5.56	4.65	4.24	

Plastic/Polystyrene 6 Unit, Polybag
 222 mm x Ø 110 mm



04087 Mint dispenser „Lightbulb“



Piece(s)	1	500	1000	5000
EUR	1.25	1.12	0.94	0.88

 Plastic/Polypropylene
  500 Unit, Bulk
 52 mm x 84 mm x 9 mm



04090 Mint dispenser „Heart“



Piece(s)	1	500	1000	5000
EUR	1.26	1.13	0.95	0.89

 Plastic/Polypropylene
  500 Unit, Bulk
 75 mm x 75 mm x 9 mm



04086 Mint dispenser „Rectangle“



Piece(s)	1	500	1000	5000
EUR	1.06	0.95	0.80	0.75

 Plastic/Polypropylene
  600 Unit, Bulk
 85 mm x 55 mm x 8 mm



04088 Mint dispenser „Round“



Piece(s)	1	500	1000	5000
EUR	1.68	1.50	1.26	1.18

 Plastic/Polypropylene
  400 Unit, Bulk
 9 mm x Ø 70 mm



04089 Mint dispenser „Shirt“

Piece(s)	1	500	1000	5000
EUR	1.17	1.05	0.88	0.82

 Plastic/Polypropylene
  400 Unit, Bulk
 74 mm x 70 mm x 9 mm

Active protection against bacteria!

#ANTIBACTERIAL

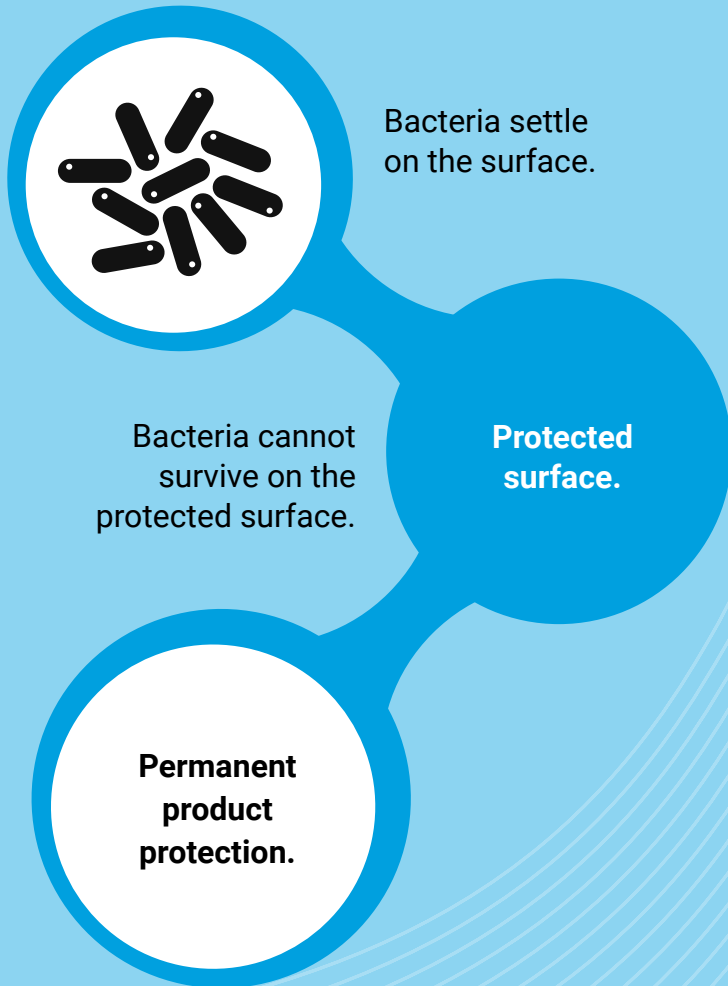

Thanks to the special components, the material **protects** against the growth of **harmful bacteria**.

This is **effective for the lifespan of the product**, and has **no impact on the recyclability** of the product.

- ✓ Eliminates > 99% of bacteria.
- ✓ Permanent antibacterial protection.
- ✓ Contains no nano-silver.

The plastic products we manufacture stand for:

Quality Made in Germany.

- ✓ Sustainable and reusable.
- ✓ Food-safe and flavour-neutral plastic.
- ✓ BPA-free and with no harmful plasticisers.
- ✓ Manufactured in Germany according to the highest quality standards.
- ✓ Production using our own green energy, and 100% recyclable

Home and Living.

- *Sheet metal articles*
- *Decoration*
- *Fly swats*
- *Doormats*
- *Kitchen accessories*
- *Sewing kits*
- *Organization*
- *Shoes and accessories*
- *Pet Accessories*
- *Doorstop*
- *Coaster*



08551 Coaster „Slate“ round

Protects against dirty glass edges and also looks elegant. Round coaster made from natural slate with authentic break line and three little feet in soft EVA against scratches on the table surface. Incl. coating against water stains.

Piece(s)	1	500	1000	5000
EUR	2.23	2.00	1.68	1.57

Stone/Slate
5 mm x Ø 100 mm

72 Unit, Individual carton +
Bubble wrap



08552 Coaster „Slate“ square

Piece(s)	1	500	1000	5000
EUR	2.17	1.94	1.63	1.52

Stone/Slate
100 mm x 100 mm x 5 mm

70 Unit, Individual carton +
Bubble wrap

08985 Place mat „Felt“

Against rattling and scratching dishes and cutlery on wood or glass tables. Ideal place mat made from 3 mm thick polyester felt, rectangular shape with rounded corners.

Piece(s)	1	500	1000	5000
EUR	1.27	1.16	1.06	0.99

Textile/Polyester-felt
450 mm x 300 mm x 3 mm

200 Unit, Polybag

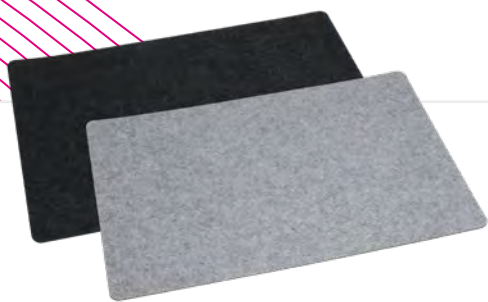

SALE!

06111 Cutlery bag „Tasca“

Elegant cutlery bag made from 3 mm thick polyester felt. Suitable for any cutlery and easy to wash by hand. Thanks to laser cutting, the material is prevented from fraying. Perfect usable as placemat with 08985 place mat „Felt“ and 08997 coaster „Aron“.

Piece(s)	1	500	1000	5000
EUR	0.53	0.47	0.40	0.37

Textile/Polyester-felt
250 mm x 90 mm x 7 mm

700 Unit, Polybag





01212 Coaster „Woody“ square

Perfect for coffee, tea and much more! Square coaster made from untreated beech wood. It provides protection against glass marks and scratches on any table. As a bar or kitchen accessory, the wooden coaster is the perfect way to protect furniture. Because the material is natural beech wood, there may be variations in the colour and grain.

Piece(s)	1	500	1000	5000
EUR	1.26	1.13	0.95	0.89

Wood/Beech wood
100 mm x 100 mm x 7 mm

100 Unit, Bulk



01213 Coaster „Woody“ round

Piece(s)	1	500	1000	5000
EUR	1.19	1.07	0.90	0.84

Wood/Beech wood
7 mm x Ø 100 mm

100 Unit, Bulk

SALE!



09314 Coaster „Card“

Better than a beer mat. Card-shaped coaster made from ABS with integrated bottle opener. The bottom surface is equipped with an EVA badge guaranteeing an anti-skid effect.

Piece(s)	1	500	1000	5000
EUR	0.54	0.49	0.40	0.37

Plastic/ABS 500 Unit, Polybag
 85 mm x 55 mm x 4 mm



09313 Coaster „Tricot“

1 item - 2 functions. Tricot-shaped coaster made from ABS with integrated bottle opener. The bottom surface is equipped with an EVA badge guaranteeing an anti-skid effect.

Piece(s)	1	500	1000	5000
EUR	0.80	0.72	0.61	0.57

Plastic/ABS 500 Unit, Polybag
 100 mm x 98 mm x 4 mm

All articles on this page with anti-slip underside!



09312 Coaster „Round“

2 in 1. Round coaster made from ABS with integrated bottle opener. The bottom surface is equipped with an EVA badge guaranteeing an anti-skid effect.

Piece(s)	1	500	1000	5000
EUR	0.63	0.57	0.48	0.45

Plastic/ABS 500 Unit, Polybag
 4 mm x Ø 100 mm



08756 Coaster „Opener“

2 in 1. Useful coaster and cap lifter in one gadget. Made from plastics and equipped with an EVA badge on its underside to prevent from skidding. The integrated cap lifter is made from metal.

Piece(s)	1	500	1000	5000
EUR	0.64	0.57	0.48	0.45

Plastic/ABS 500 Unit, Polybag
 82 mm x 82 mm x 4 mm



01182 Coaster „Logan“

Practical square coaster made from ABS. Perfectly suited for an all-over digitally printed finish.

Piece(s)	1	500	1000	5000	
EUR	0.69	0.62	0.52	0.49	

Plastic/ABS 500 Unit, Bulk
 80 mm x 80 mm x 2 mm



04200 Beer mug cover

Indispensable not only in summer. Beer mug cover with large advertising space. Can also be used as a mat. IMould labelling possible.

Piece(s)	1	500	1000	5000	
EUR	0.55	0.50	0.42	0.39	

Plastic/Polystyrene 250 Unit, Bulk
 8 mm x Ø 110 mm



05031 Coaster and lid „2 in 1“

Usable as a mat or lid and available in a large selection of colours.

Piece(s)	1	500	1000	5000	
EUR	0.51	0.46	0.39	0.36	

Plastic/Polypropylene 500 Unit, Bulk
 8 mm x Ø 88 mm



NEW!

01732 Bottle cap „Kronkorken“

Keep your drinks fresher for longer! Bottle cap made from food-safe and tasteless plastic. Naturally BPA-free. This bottle cap will keep your drinks fresh for a long time and prevent sparkling drinks from becoming flat. A hygienic fastening that ensures insects are kept safely outside. Available in many different colours and perfectly suitable for marking your own drink. Comes in a standard size for all bottles that are fastened with a metal crown cap.

Piece(s)	1	500	1000	5000	
EUR	0.28	0.25	0.21	0.19	

Plastic/Polyethylene 1500 Unit, Bulk
 Ø 25 mm

SALE!



01023 Bottle cap „Close“

The bottle cap keeps prosecco and bubbly wines carbonated. The white cap is suitable for most prosecco and wine bottles. The cap includes a sealing ring.

Piece(s)	1	100	500	1000
EUR	1.53	1.37	1.16	1.07

Plastic/Acryl

400 Unit, Polybag

75 mm x 50 mm x 15 mm



05120 Bottle holder „Store“

For cans and cups between 0.2 and 0.5 litres. Variable circumference. Suitable for virtually any kind of car - clip-on type.

Piece(s)	1	500	1000	5000
EUR	0.63	0.57	0.48	0.45



Plastic/Polypropylene

150 Unit, Bulk

73 mm x 130 mm x 130 mm



07041 Beer bottle crate „Six Pack“

Ideal also for giving away single bottles. Suitable for six beer bottles (0.5 litres).

Piece(s)	1	50
EUR	17.22	15.42

Wood/Birch wood

15 Unit, Bulk

225 mm x 160 mm x 310 mm



05005 Beer bottle carry-all „Take 6“

Foldable bottle carry-all for up to six beer or lemonade bottles. Ideal give-away with usage instructions. Easy assembly.

Piece(s)	1	100	500	1000
EUR	5.45	4.88	4.11	3.84

📦 Plastic/Polypropylene 📦 25 Unit, Polybag
 📏 270 mm x 174 mm x 257 mm



04865 Beer mat stand „Beer crate“

Small box in the shape of a beer crate. For use as a notelet box or beer mat stand. Supplied unfilled.

Piece(s)	1	500	1000	5000
EUR	1.51	1.35	1.14	1.07

📦 Plastic/Polystyrene 📦 100 Unit, Bulk
 📏 104 mm x 75 mm x 67 mm



06089 Beer coaster holder „Hill“

Triangle beer coaster holder with large advertising space on both sides. For all common beer coaster types.

Piece(s)	1	500	1000	5000
EUR	2.02	1.79	1.48	1.38

📦 Plastic/Polystyrene 📦 50 Unit, Bulk
 📏 135 mm x 72 mm



Foam rubber feet for safe, non-slip stand!

NEW!



01820 Beer coaster holder „Gastro“

The eye-catcher on every table. Menu card holder and beer coaster stand in one. Made of natural beech wood. Includes 4 EVA feet on the base.

Piece(s)	1	100	500
EUR	6.37	5.70	4.80

📦 Wood/Beech wood 📦 112 Unit, Individual carton + Polybag
 📏 110 mm x 50 mm x 50 mm
 ⚠️ Decoration



06090 Menu card holder „Hill“

Classic menu holder with triangle stand and 2 crystal clear holder surfaces. Perfect for menu cards, ice cream menu or for beverage lists.

Piece(s)	1	100	500	1000
EUR	6.11	5.45	4.58	4.29

📦 Plastic/Acryl

📦 50 Unit, Bulk

📏 180 mm x 105 mm x 55 mm



01631 Wooden menu holder „Cube“

An eye-catcher for any table. A square menu holder made from oak wood with a groove for menus etc. As wood is a natural product, variations in colour and grain may occur.

Piece(s)	1	100	500	1000
EUR	6.42	5.75	4.84	4.52

📦 Wood/Oakwood

📦 48 Unit, Bulk

📏 60 mm x 60 mm x 60 mm



Foam rubber feet for safe, non-slip stand!



01033 Menu card holder „Concrete“

The Highlight on every table. Concrete menu card holder, with two different slots of different depth for inserting the menus. Includes foam rubber feet on the bottom for anti-slip function.

Piece(s)	1	100	500	1000
EUR	3.05	2.73	2.30	2.14

📦 Stone/Concrete

📦 18 Unit, Individual carton + Polybag

📏 100 mm x 45 mm x 50 mm



Foam rubber feet for safe, non-slip stand!

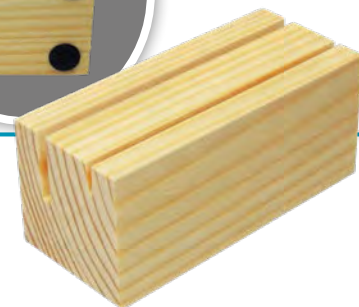

NEW!

01821 Menu card holder „Gastro“

The eye-catcher on every table. Menu card holder made of natural beech wood with two different slots for inserting the menus. Including 4 EVA feet on the bottom.

Piece(s)	1	100	500
EUR	8.46	7.57	6.38

📦 Wood/Beech wood

📦 112 Unit, Individual carton + Polybag

📏 110 mm x 50 mm x 45 mm

⚠️ Decoration



05113 Top hat Cavalier large

Neat bottle cooler in the shape of an inverted top hat made of break-proof plastic. With large advertising space.

Piece(s)	1	100	500	1000	
EUR	3.45	3.09	2.60	2.43	

Plastic/Polystyrene
 218 mm x 120 mm

16 Unit, Bulk



Magnetic!



01195 Kitchen timer „Falun“

Optimal timing in the kitchen! The cylindrical kitchen timer has a manual adjustment time ranging from 1 - 60 minutes. The timer is made from stainless steel and has a magnet on the bottom for attachment to metal surfaces.

Piece(s)	1	100	500	1000
EUR	7.33	6.56	5.53	5.16

Metal/Stainless steel
 47 mm x Ø 60 mm

100 Unit, Individual carton + Polybag



08688 Flag picker „Germany“

Perfect for any fan party. 12 cm long wooden sticks with sharpened bottom and small paper flag in German colours. Ideal for decorating finger food. A set of 10 pieces in a plastic bag.

Piece(s)	1	500	1000	5000
EUR	0.45	0.41	0.34	0.32

Paper/Cardboard
 50 mm x 35 mm x 130 mm

2000 Unit, Polybag





01656 Oven glove „Heat resistant“, set of 2

A beautiful pair of oven gloves that will make a perfect addition to your kitchen. The quilted gripping side safely protects your hands from hot surfaces such as oven grilles, baking trays or casseroles. Machine washable at up to 30°C.

Piece(s)	1	50	250	500
EUR	9.43	8.44	7.11	6.63

 Textile/Cotton + PP

 36 Unit, Polybag

 365 mm x 180 mm x 20 mm

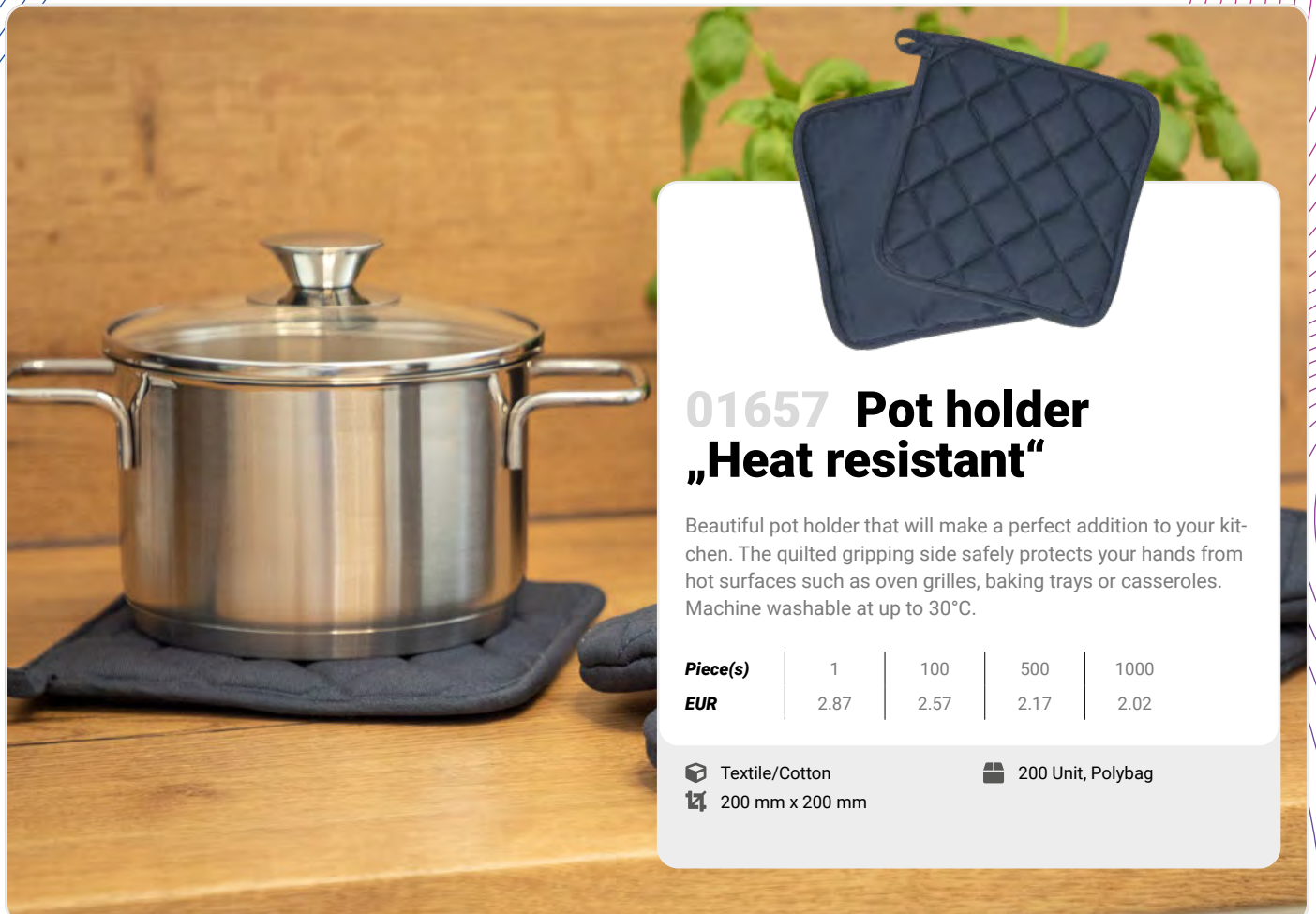

01657 Pot holder „Heat resistant“

Beautiful pot holder that will make a perfect addition to your kitchen. The quilted gripping side safely protects your hands from hot surfaces such as oven grilles, baking trays or casseroles. Machine washable at up to 30°C.

Piece(s)	1	100	500	1000
EUR	2.87	2.57	2.17	2.02

 Textile/Cotton

 200 Unit, Polybag



 200 mm x 200 mm



05150 Divider „Triangle“

Plastic pyramid with large advertising space on all three sides.

Piece(s)	1	100	500	1000
EUR	2.81	2.52	2.12	1.98

 Plastic/Polypropylene
 350 mm x 40 mm x 37 mm



 100 Unit, Bulk



04430 Bag clip „Easy Fresh“

Practical kitchen accessories. Whether chips or cornflakes ... with this chip open packs and bags can be closed without a problem.

Piece(s)	1	500	1000	5000	
EUR	0.42	0.36	0.27	0.24	

 Plastic/Polypropylene
 83 mm x 20 mm x 21 mm



 500 Unit, Bulk



09070 Tube Pusher „Squeeze“

Get the last little bit out of your tube! Whether hand cream, toothpaste or tomato paste - the tube pusher ensures that everything comes out of the tube simply and efficiently. Simply place it over the tube from the bottom and push it piece by piece until the tube is completely empty.

Piece(s)	1	500	1000	5000
EUR	0.22	0.20	0.17	0.15

 Plastic/Polypropylene
 90 mm x 38 mm x 8 mm

 1000 Unit, Polybag



05134 Box „C-Box“

Beautifully shaped box for storing and transporting cosmetic articles or other important little things. With practical click-lock.

Piece(s)	1	500	1000	5000	
EUR	0.76	0.68	0.57	0.53	

Plastic/Polypropylene 150 Unit, Bulk
 101 mm x 78 mm x 30 mm



04084 Universal box „Mini“

Universal box for things like business cards, jewellery, plasters, chewing gum and much more. Available in a large selection of colours.

Piece(s)	1	500	1000	5000	
EUR	0.60	0.53	0.45	0.42	

Plastic/Polypropylene 250 Unit, Bulk
 101 mm x 67 mm x 11 mm



04830 Storage box „Swimming box“

Watertight bathing box with screw cap, ring seal and cord. You will never need to leave your valuables out of your sight.

Piece(s)	1	500	1000	5000	
EUR	1.31	1.17	0.99	0.92	

Plastic/Polystyrene 200 Unit, Bulk
 115 mm x Ø 39 mm



05478 Box „Flat“

The box with the child lock. Great, flat plastic box with special lock which can only be opened by lifting two opposed quick-release catches. Ideal for stowing things that should not be handled by children.

Piece(s)	1	500	1000	5000	
EUR	1.60	1.43	1.21	1.13	

Plastic/Polypropylene 70 Unit, Bulk
 158 mm x 118 mm x 30 mm

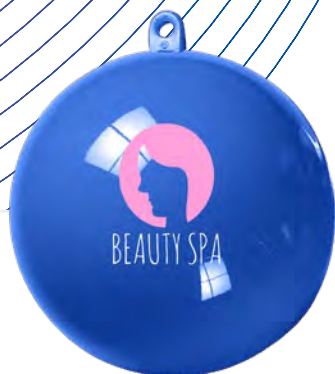

05315 Plastic bauble "mini ball"

Versatile for individual filling, this small 2-part jar made of polystyrene with eye for hanging up. Custom colours on request. Foodstuffs need to be separately wrapped.

Piece(s)	1	500	1000	5000	
EUR	0.58	0.52	0.44	0.41	

Plastic/Polystyrene
 Ø 60 mm

250 Unit, Bulk



01532 Wooden box „Pino“, small without dividing compartments

Practical, useful and attractive. The wooden box has a foldable metal fastening and is perfect for keeping things tidy, storing collector items and lots more. The box is made from natural spruce, which means there may be variations in the colour and grain. This material is very good for decorating using decoupage, painting, poker work or similar. Whether oiled, colour glazed or untreated, the box always looks good.

Piece(s)	1	50	200	500
EUR	7.58	6.74	5.86	5.59

Wood/Spruce wood
 210 mm x 160 mm x 85 mm

20 Unit, Bulk
 Decoration



05267 Plastic bauble "mini heart"

Versatile for individual filling, this small 2-part jar made of polystyrene with eye for hanging up. Custom colours on request. Foodstuffs need to be separately wrapped.

Piece(s)	1	500	1000	5000	
EUR	0.46	0.41	0.35	0.32	

Plastic/Polystyrene
 63 mm x 65 mm x 35 mm

300 Unit, Bulk

05262 Plastic bauble "maxi heart"

Piece(s)	1	500	1000	5000	
EUR	1.32	1.19	1.00	0.93	

Plastic/Polystyrene
 108 mm x 100 mm x 60 mm

100 Unit, Bulk



04436 Sock collector „Laundry“

Never again fetch single socks from the washing machine. With the practical socks collectors, stockings etc can be washed in pairs and hung straight to dry thanks to the integrated hook. What belongs together is left together. Also ideal for using as a product hanger.

Piece(s)	1	500	1000	5000	
EUR	0.27	0.24	0.20	0.19	

Plastic/Polyethylene 600 Unit, Bulk
 51 mm x 90 mm x 4 mm



01204 Clothes hanger „Woody“

Timeless clothes hanger made of beech wood, with a metal hook. Due to its sturdy construction, the hanger is ideally suited for holding heavy garments. With a crossbar for hanging trousers and skirts. The precise notches at either end enable the secure hanging of garments with straps. Since wood is a natural product, variations in the colour and grain cannot be ruled out.

Piece(s)	1	100	500	1000
EUR	2.41	2.16	1.82	1.70

Wood/Birch wood 60 Unit, Bulk
 440 mm x 250 mm x 16 mm



01073 Door sign „Plaza“

Decorative slate board for your house door. The door sign made from waterproof stone impresses with its natural broken external edges and the beautiful colour. The jute cord means it can be easily mounted anywhere. The cord is 30 cm long. Easy to clean. Due to the natural material, there may be variations in the colour and texture.

Piece(s)	1	100	500	1000
EUR	3.74	3.35	2.82	2.63

Stone/Slate 30 Unit, Individual carton + Bubble wrap
 250 mm x 100 mm x 5 mm

NEW!



01883 Door sign „Woody“

The high-quality, robust door sign looks perfect on every door. In oiled beech wood.

Piece(s)	1	100	500	1000
EUR	5.63	5.04	4.24	3.96

Wood/Oakwood Bulk
 172 mm x 75 mm

09311 Doormat „Home“, small



There's no place like home. Water-repellent doormat with anti-skidding effect. Easy to clean with a cloth. The absorbent non-woven surface can be completely refined with a photorealistic all-over imprint.

Piece(s)	1	50	250	500
EUR	9.87	8.82	7.44	6.94

Plastic/Rubber
600 mm x 400 mm x 3 mm

50 Unit, Polybag

09310 Doormat „Home“, large

Piece(s)	1	50	250	500
EUR	13.94	12.48	10.51	9.81

Plastic/Rubber
750 mm x 500 mm x 3 mm

50 Unit, Polybag



08568 Sewing set „Travel“

Useful for travelling thanks to its handy size. Great sewing set with a pair of scissors, two spare buttons, two safety pins, one embroidery needle, one pin, a threader and a 6-piece sewing thread set (brown, yellow, red, green, white, black). Incl. white sleeve for inserting. Offers an efficient advertising space.

Piece(s)	1	500	1000	5000
EUR	0.74	0.67	0.56	0.53

Plastic/Polystyrene
90 mm x 55 mm x 7 mm

400 Unit, Polybag



08289 Shoe shining set „Fusion“

Always well-looked-after shoes. Practical shoe shine set in a metal box. Small brush with wooden handle, small tin with colourless shoe cream, small shoehorn made of ABS and a cleaning cloth made of 100 % cotton.

Piece(s)	1	100	500	1000
EUR	5.28	4.89	4.49	4.20

Metal
110 mm x 75 mm x 45 mm

72 Unit, Individual carton + Polybag



01090 Shoe horn „Madera“, small

Helps you to put your shoes on quickly! This oiled beech wood shoehorn is robust, and can be stored in a small area due to its handy size. With opening for hanging up. Since the article is made of natural materials, actual colouring and grain may differ from product to product.

Piece(s)	1	100	500	1000
EUR	2.25	2.02	1.70	1.58

Wood/Beech wood
 265 mm x 35 mm x 10 mm

350 Unit, Bulk

01096 Shoe horn „Madera“, large with backscratcher

Piece(s)	1	100	500
EUR	5.86	5.25	4.42

01091 Shoe horn „Madera“, large

Piece(s)	1	100	500
EUR	7.02	6.28	5.29

01096
 585 mm x 38 mm x 20 mm
 167 Unit, Bulk

01091
 630 mm x 38 mm x 10 mm
 100 Unit, Bulk



05103 Shoe horn „Cliff“

Long, ergonomic shoe horn featuring eyelet for hanging.

Piece(s)	1	500	1000	5000	
EUR	1.56	1.39	1.17	1.10	

Plastic/Polypropylene
 430 mm x 35 mm x 45 mm

150 Unit, Bulk



05092 Shoe horn „Grip“

The smooth surface and great shape make it easy for you to slip into your shoes. Handy format and with a eye for hanging up. Available in a large selection of colours.

Piece(s)	1	500	1000	5000	
EUR	0.57	0.50	0.41	0.39	

Plastic/Polypropylene
 174 mm x 43 mm x 15 mm

500 Unit, Bulk

NEW!



01882 Shoe horn „Tiny“

This handy helper will get you into every shoe with its ergonomic shape. Oiled beech wood and leather provide the highest quality and elegant design.

Piece(s)	1	100	500	1000
EUR	4.19	3.75	3.16	2.95

Wood/Beech wood
120 mm x 40 mm

Bulk



06650 Slippers „Frottee“

Soft slippers - single size, comfortable to wear. Ideal for hotel and wellness industry.

Piece(s)	1	500	1000	5000
EUR	1.93	1.73	1.45	1.36

Textile/Terry cloth

100 Unit, Polybag

275 mm x 110 mm x 30 mm

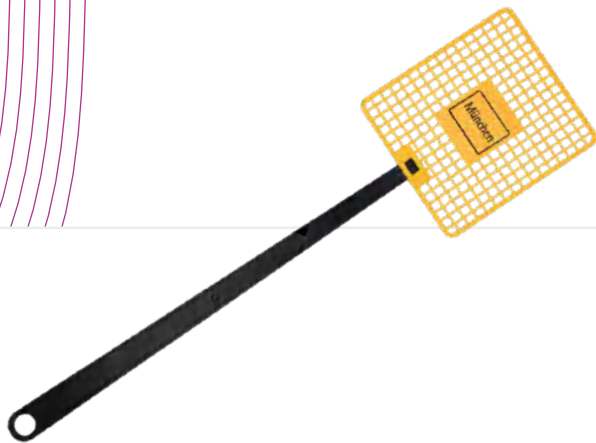

07123 Fly swatter „Logo“

Square fly swatter with extra large advertising space at centre. Available in a large selection of colours.

Piece(s)	1	500	1000	5000
EUR	1.17	1.05	0.89	0.83



Plastic/Polypropylene
350 mm x 90 mm x 8 mm

150 Unit, Bulk



05501 Fly swatter „Kit“

Kit shaped. With 1 advertising space on each side at the centre of the swatter. Available in a large selection of colours.

Piece(s)	1	500	1000	5000
EUR	1.33	1.19	1.00	0.93

Plastic/Polypropylene

150 Unit, Bulk

372 mm x 115 mm x 7 mm





01068 Dog bowl „Dog“

Robust feeding bowl made from stainless steel, for puppies, dogs and cats. Perfect for dry and wet feed, treats or water. Its clever design means that the bowl cannot tip over. The rubber ring prevents slipping and protects the base from scratches. Easy to clean and long-lasting. Capacity: Approx. 1.0 litre.

Piece(s)	1	100	500	1000
EUR	5.42	4.85	4.09	3.81

 Metal/Stainless steel

 50 Unit, Polybag

 55 mm x Ø 255 mm

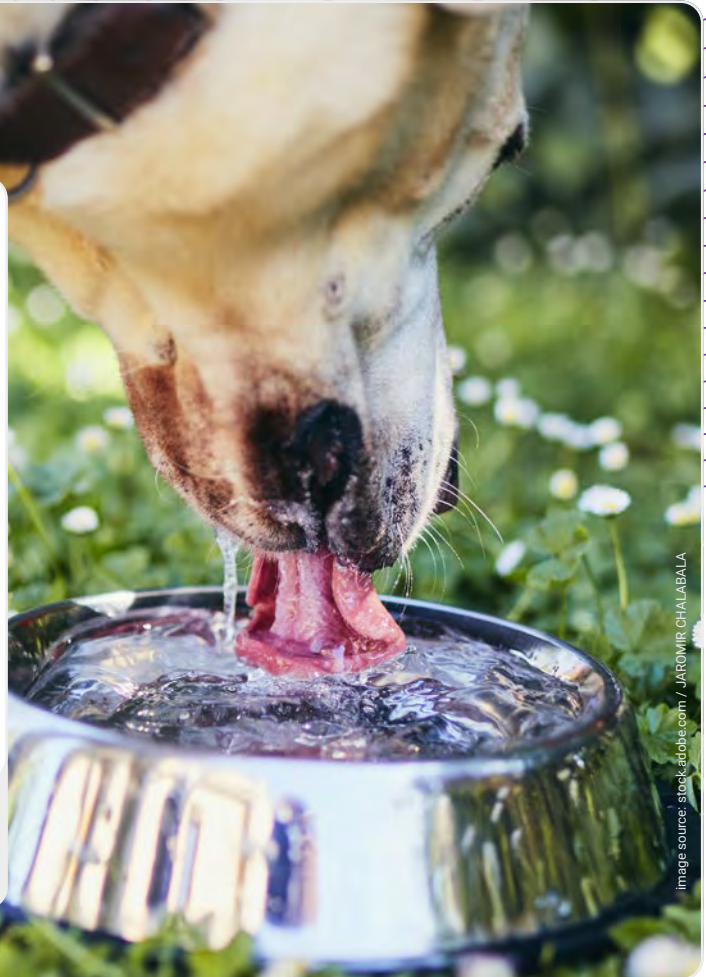

image source: stock.adobe.com / JAROMIR CHALABALA





01051 Animal travel blanket „Travel“

A comfortable resting place on the road. Quilted animal travel blanket in two colours, filled with polyester padding. Finishing is possible on the bottom side and on the top.

Piece(s)	1	50	250	500
EUR	9.50	8.51	7.17	6.69

 Textile/Polyester-felt

 40 Unit, Polybag

 690 mm x 540 mm





01050 Grooming glove „Pet“

Relaxing time for human's best friend. Glove with integrated silicone „brush“ for a shiny dog coat and easier hair removal during the shedding phase. Suitable for right-handers. Advertising possible on the closure at the wrist.

Piece(s)	1	100	500	1000
EUR	4.41	3.94	3.32	3.10

Textile/Polyester
 240 mm x 160 mm

150 Unit, Polybag



08976 Dog Waste Dispenser „Dog“

Ideal for all dog owners. 15 Black plastic bag (thickness 1.2 mm) in plastic dispenser in capsule form with a convenient slot. With the help of the plastic snap hooks, the bag dispenser can be attached comfortably at the belt or similar object, so that you always have both hands free.

Piece(s)	1	500	1000	5000
EUR	0.92	0.82	0.69	0.65

Plastic/Polypropylene
 140 mm x Ø 43 mm

300 Unit, Polybag



01333 Poo bag dispenser „Bone“

The hard cover of the „Bone“ poo bag dispenser is made of nylon and comes with an aluminium hook, which makes it easy to mount. It is closed using a zip fastener. Incl. one roll of poo bags with 15 bags.

Piece(s)	1	100	500	1000
EUR	3.51	3.15	2.65	2.47

Textile/Nylon
 115 mm x 65 mm x 32 mm

200 Unit, Polybag



01052 Dog treat bag „Goodie“

Treats - to Go. Goodie bag with carabiner for attaching to the belt. Main compartment with cord closure incl. insert pocket for treats and 20 small PE dog waste bags.

Piece(s)	1	100	500	1000
EUR	4.61	4.12	3.45	3.16

Textile/Polyester 600D
 120 mm x Ø 90 mm



50 Unit, Polybag



01366 Cooling mat for animals „Chill“, large

This cooling mat offers a refreshing place to rest on warm summer days. The cooling effect of the gel in the mat is activated by the pressure of your pet's body. To recharge, place the mat in a cool place. The smooth surface material can easily be cleaned by hand using a damp cloth, and dries well. The mat can be used in the house, garden, and when travelling. When not in use, simply fold together and store in a dry place at room temperature.

Piece(s)	1	25	100	250
EUR	24.58	22.00	18.53	17.29



 Textile/100% Polyester
 750 mm x 950 mm

 3 Unit, Polybag



01367 Cooling mat for animals „Chill“, small

Piece(s)	1	50	250	500
EUR	10.64	9.52	8.02	7.49

 Textile/100% Polyester
 400 mm x 600 mm

 6 Unit, Polybag

Office and School.

- *Stickers and magnets*
- *Letter opener*
- *Computer and telephone accessories*
- *Pencil case and organizer*
- *Stapling, stapling and holding*
- *Rulers and stencils*
- *Magnifiers*
- *Colouring books and writing pads*
- *Notebooks and notepads*
- *Promotion Cases*
- *Erasers*
- *Calculators and pocket calculators*
- *Sharpeners*
- *Pencils and pens*
- *Business card cases*



06287 Pencil „Nature“ short

Useful and handy. Short pencil made from natural wood with 6 printable segments via hexagonal form. HB Lead.

Piece(s)	1	500	1000	5000
EUR	0.11	0.10	0.09	0.07

Wood 5000 Unit, Bulk
85 mm x Ø 7 mm

06293 Pencil „Nature“ long

Piece(s)	1	500	1000	5000
EUR	0.12	0.11	0.09	0.08

Wood 2500 Unit, Bulk
175 mm x Ø 7 mm



06282 Pencil „Carpenter“

Classic carpenter's pencil with typical oval shape allows for larger advertising surface than on normal pencils. Delivered unsharpened.

Piece(s)	1	500	1000	5000
EUR	0.55	0.49	0.42	0.39

Wood 1000 Unit, Bulk
240 mm x 11 mm x 7 mm

SALE!



01014 Carpenter's pencil „Deluxe“

The practical plastic version of the classic carpenter's pencil. Printable plastic case with pencil lead and locking function for the lead. Including 2 lead refills in the case and sharpener at the end piece of the slider.

Piece(s)	1	500	1000	5000
EUR	0.97	0.87	0.73	0.69

Plastic/Polypropylene 1000 Unit, Polybag
180 mm x 15 mm x 12 mm



06259 Pencil „Black“

You'll definitely need this some time. Round pencil with black coating. Lead hardness HB. Custom colours on request.

Piece(s)	1	500	1000	5000
EUR	0.10	0.09	0.08	0.07

Wood
176 mm x Ø 7 mm

2500 Unit, Bulk



06271 Pencil „White“ with eraser

Round pencil with integrated eraser on top.

Piece(s)	1	500	1000	5000
EUR	0.14	0.12	0.10	0.10

Wood
190 mm x Ø 7 mm

2500 Unit, Bulk

SALE!



06398 Crayon set „Skinny“

12 long, unpainted crayons in triangular shape and 1 white pencil sharpener for thin and thick pencils, packed in a slipcase made of natural-coloured cardboard (400 g).

Piece(s)	1	500	1000	5000
EUR	1.26	1.12	0.94	0.89

Wood
220 mm x 64 mm x 18 mm

240 Unit, Individual carton
Toys, 4+, 8



06399 Coloured pencil set „Jumbo“

6 thick, long pencils in triangular shape made of unpainted wood and 1 white pencil sharpener, packed in a slipcase made of natural-coloured cardboard (400 g).

Piece(s)	1	500	1000	5000
EUR	1.96	1.65	1.47	1.42





Wood
220 mm x 60 mm x 18 mm

96 Unit, Individual carton + Polybag
Toys, 4+, 8

06292 Coloured pencil set „Nature 6“ short

Short pencils made from unpainted wood comes as a set of 6 and packed in cardboard.





Piece(s)	1	500	1000	5000
EUR	0.38	0.34	0.29	0.27

 Wood
 960 Unit, Individual carton
 90 mm x 47 mm x 10 mm
 Toys, 4+



06297 Crayon set „Nature 6“ long

Piece(s)	1	500	1000	5000
EUR	0.63	0.57	0.48	0.45

 Wood
 480 Unit, Individual carton
 180 mm x 47 mm x 10 mm
 Toys, 4+







SALE!

06298 Coloured pencil set „Nature 12“ long

Long colouring pencils, unpainted and comes as a set of 12 in cardboard packaging. All 12 pencils are hexagonal (6 sided).





Piece(s)	1	500	1000	5000
EUR	0.94	0.84	0.72	0.67

 Wood
 144 Unit, Individual carton
 180 mm x 90 mm x 9 mm
 Toys, 4+

06280 Crayon „Rainbow“ thin

Colouring pencil with protective lacquer and 4 colours of lead, in colours red, yellow, blue and green. Due to the hexagonal shape of the pencil there are 4 printable sides.

Piece(s)	1	500	1000	5000
EUR	0.48	0.43	0.36	0.34

 Wood
 2500 Unit, Bulk
 176 mm x ø 7 mm
 Toys, 4+



04344 Children's coloured pencil set „Eco Line“

Making the world a bit brighter. Childrens colouring set packed in naturally coloured cartons. With 10 coloured pencils made from natural wood in hexagonal form, 1 small colouring book with 20 sides and different designs for painting, 1 plastic sharpener and 1 ruler with cm and inch scaling.

Piece(s)	1	500	1000	5000
EUR	1.23	1.11	0.93	0.87

Paper/Cardboard
 180 mm x 75 mm x 14 mm

300 Unit, Individual carton + Polybag
 Toys, 4+, 8



06408 Coloured pencil set „Sharpener“

Handy 2in1 set containing 12 short, unpainted wooden colouring pencils in a cardboard cylinder, with transparent plastic cover and built in sharpener. All pencils are round.

Piece(s)	1	500	1000	5000
EUR	1.03	0.92	0.77	0.72

Paper/Cardboard
 108 mm x Ø 35 mm

120 Unit, Polybag
 Toys, 4+, 8



06690 Pencil holder „Basic“ large

Round cardboard pen holder, filled with 12 long, natural colouring pencils in hexagonal form.

Piece(s)	1	500	1000	5000
EUR	1.63	1.46	1.23	1.15

Paper/Cardboard
 190 mm x Ø 36 mm

240 Unit, Individual carton
 Toys, 4+

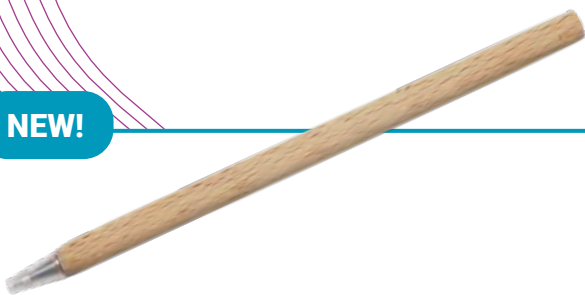
NEW!

01866 Pen „Beech“

Untreated beech wood ballpoint pen in the classic shape of a pencil. A plastic closure cap protects the lead. Black ink.

Piece(s)	1	500	1000	5000
EUR	0.54	0.49	0.41	0.38

Wood/Beech wood
 1000 Unit, Polybag
 145 mm

NEW!

01867 Pen „Shirakami“

Sustainable writing: the elegant ballpoint pen in beech wood with natural wood grain, a black metal tip and a black metal tip. Black ink.

Piece(s)	1	500	1000	5000
EUR	1.71	1.53	1.29	1.20

Wood/Beech wood
 1000 Unit, Polybag
 140 mm



09095 Ball pen „Novi“

Blue ink. Elegant ball pen with push button and metal clip. The metallic shimmering housing in different colours appears particularly stylish because of the two silver dividing lines.

Piece(s)	500	1000	5000
EUR	0.59	0.56	0.53

Metal/Chrome
 500 Unit, Bulk
 136 mm x ø 10 mm

SALE!

06379 Pen „Touch Pen“

Elegant pen with practical touch pen. Capacitive stylus pen for all smartphones and tablet PCs. The pen writes in blue and has a twist mechanism.

Piece(s)	1	500	1000	5000
EUR	0.70	0.64	0.60	0.59

Metal
 1000 Unit, Polybag
 130 mm x ø 9 mm





09094 Ball pen „Yuma“

Blue ink. Light retractable ballpoint pen with white housing and metal clip. Thanks to its transparent colour rubber the pen is anti-skidding.

Piece(s)	500	1000	5000
EUR	0.23	0.22	0.19

 Plastic

 1000 Unit, Bulk

 141 mm x Ø 17 mm



09496 Pen roll „Cork“

Flexible cork. Pen roll covered with natural cork. The inside is made from linen-coloured textile and contains an eraser, a pencil sharpener, a wooden ruler and 12 coloured pencils made from untreated wood. The overwrap prevents the utensils from falling out. The roll is closed by a button and a rubber strap.

Piece(s)	1	100	500	1000
EUR	6.29	5.63	4.75	4.43

Wood/Cork

80 Unit, Polybag

200 mm x 20 mm



09498 Pencil case „Cork“

This cylindrical pencil case made from linen-coloured textile with cork exterior offers space for many pencils. Incl. zipper and strap.

Piece(s)	1	100	500	1000
EUR	3.30	2.95	2.49	2.32

Wood/Cork

60 Unit, Polybag

200 mm x 60 mm



SALE!

09495 Organizer „Cork“

Beautiful file with cork on its outside and textile interior with zipper. Various straps and flaps make sure that there is space for one eraser, one sharpener, one ruler, two pencils, one fine liner and a notebook. The outside is equipped with a brown PU badge.

Piece(s)	1	100	500	1000
EUR	4.65	4.50	4.36	4.28

Wood/Cork

40 Unit, Polybag

210 mm x 160 mm x 25 mm



04291 Pencil sharpener „Helmet“

Pencil sharpener in the shape of a helmet. An advertising article with a very long working life. Available in various shapes it is perfect for various promotion activities.

Piece(s)	1	500	1000	5000	
EUR	1.70	1.52	1.28	1.20	

Plastic
 58 mm x 40 mm x 46 mm

500 Unit, Bulk



04306 Pencil sharpener „Trash Can“

Pencil sharpener in the shape of a dustbin with cap. An advertising article with a very long working life. Available in various shapes it is perfect for various promotion activities.

Piece(s)	1	500	1000	5000	
EUR	1.99	1.78	1.50	1.40	

Plastic/Polystyrene
 36 mm x 42 mm x 62 mm

500 Unit, Bulk

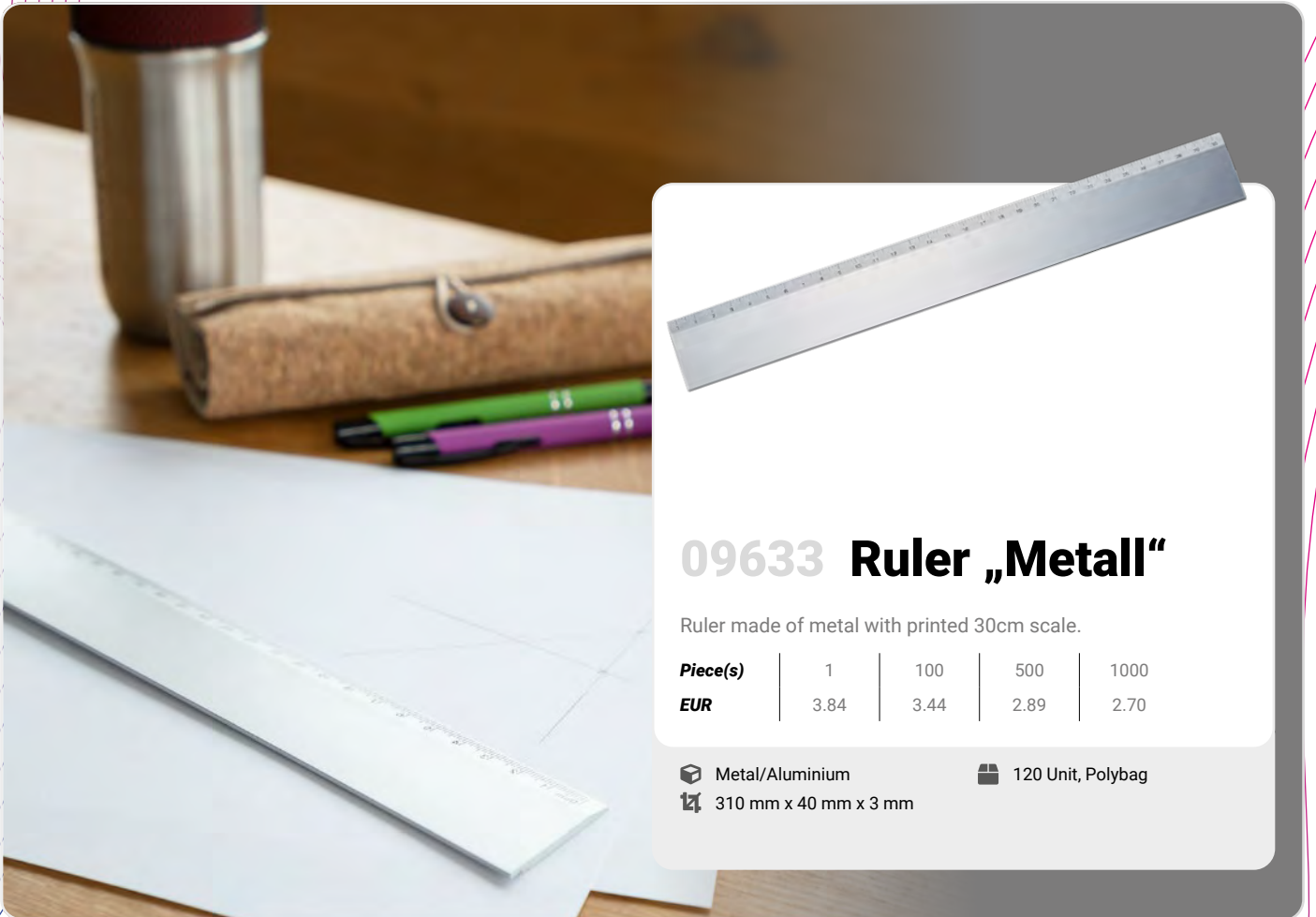

09633 Ruler „Metall“

Ruler made of metal with printed 30cm scale.

Piece(s)	1	100	500	1000
EUR	3.84	3.44	2.89	2.70

Metal/Aluminium

120 Unit, Polybag

310 mm x 40 mm x 3 mm



03883 Ruler „16 cm“

Sturdy 16 cm long ruler made from plastic with moulded-on millimeter scale on one side. Without printing as standard. Hole on one side.

Piece(s)	1	500	1000	5000	
EUR	0.59	0.53	0.45	0.42	

Plastic/Polystyrene
 180 mm x 29 mm x 2 mm

500 Unit, Bulk

03885 Ruler „30 cm“

Piece(s)	1	500	1000	5000	
EUR	1.13	1.02	0.86	0.80	

03884 Ruler „20 cm“

Piece(s)	1	500	1000	5000	
EUR	0.78	0.70	0.59	0.55	

03885
 311 mm x 37 mm x 3 mm
 250 Unit, Bulk

03884
 215 mm x 35 mm x 3 mm
 600 Unit, Bulk



03715 Ruler „Poly-S“

Transparent ruler with 33cm and 13 inch scale. Scales and company logo possible in one colour.

Piece(s)	1	100	500	1000
EUR	3.50	3.13	2.64	2.46

Plastic/Polystyrene 120 Unit, Polybag
 345 mm x 48 mm x 5 mm



03312 Eraser „Square“

Square eraser, various colours. Customisable as of 5,000 units.

Piece(s)	1	500	1000	5000
EUR	0.56	0.50	0.42	0.40



Plastic/TPE 1000 Unit, Bulk
 39 mm x 29 mm x 7 mm

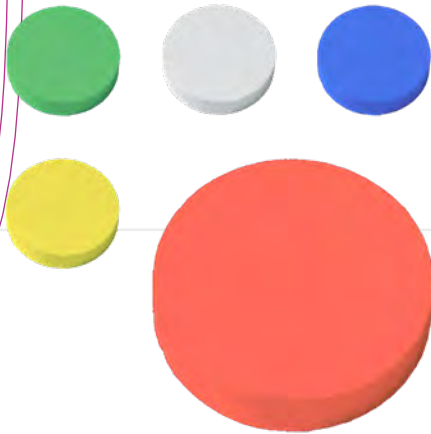

03311 Eraser „Round“

Round. Classic eraser for erasing pencil and crayon drawings. Customisable as of 5,000 units.

Piece(s)	1	500	1000	5000
EUR	0.63	0.56	0.47	0.44



Plastic/TPE 1000 Unit, Bulk
 7 mm x Ø 34 mm



04046 Eraser „Pill“

Indispensable in the office. Eraser with cap in the shape of a pill. Ideal for use in doctors' surgeries and chemists.

Piece(s)	1	500	1000	5000
EUR	1.22	1.09	0.92	0.86



Plastic/ABS 400 Unit, Bulk
 64 mm x Ø 24 mm



01003 Notebook „Note“ A5



Perfect for collecting notes, Hardcover notebook with 80 checked pages, elastic band for closing and a paper pocket on the last page. Due to special coating the outer material is more impassible. Available in black and white. A5 format.

Piece(s)	1	100	500	1000
EUR	2.98	2.67	2.25	2.10

 Paper/Cardboard  40 Unit, Polybag
 215 mm x 148 mm x 13 mm

01002 Notebook „Note“ A4

Piece(s)	1	100	500	1000
EUR	5.58	4.99	4.21	3.93



 Paper/Cardboard  20 Unit, Polybag
 297 mm x 210 mm x 13 mm



07091 Notebook „Agenda“ A6

PVC coated notebook with black rubber band and 96 chequered pages in DIN A6. Quality of the paper: white 70g/qm, double-side offset. With paperbag on the backside.

Piece(s)	1	100	500	1000
EUR	3.76	3.37	2.84	2.65



 Plastic/PVC  90 Unit, Polybag
 95 mm x 145 mm x 18 mm



07093 Notebook „Agenda“ A4

Piece(s)	1	100	500	1000
EUR	9.36	8.38	7.06	6.59

07092 Notebook „Agenda“ A5

Piece(s)	1	100	500	1000
EUR	4.53	4.05	3.41	3.18

07093
 295 mm x 214 mm x 15 mm
 20 Unit, Polybag

07092
 210 mm x 145 mm x 15 mm
 40 Unit, Polybag



08950 Notebook „2Tone“

DIN A5 format notebook with 80 chequered sheets. The haptic and peculiar two-color-effect which arises by laser engraving provides for a durable and impressive advertising success. The textile ribbon in matching color rounds off the stylish design. Ideal for individual item manufacturing.

Piece(s)	1	100	500	1000
EUR	4.07	3.64	3.07	2.86

Plastic/Polyurethane
 40 Unit, Polybag
 210 mm x 150 mm x 13 mm

SALE!



01039 Notebook „Style“, A5

Trendy hardcover notebook with two colored cover. With 80 square-paper pages and vertical rubber closure band, which can also be used as a pen holer. Durable PU outer material. A5 format

Piece(s)	1	100	500	1000
EUR	3.53	3.16	2.66	2.49

Plastic/Polyurethane
 50 Unit, Polybag
 215 mm x 145 mm x 15 mm



08092 Notebook „Felt“

Modern notebook with felt cover in anthracite and with black rubber band for closing. 80 sheets (chequered) in DIN A5 format. Paper quality: white 70 g/m2, double-side offset.

Piece(s)	1	100	500	1000
EUR	5.06	4.53	3.82	3.56

Textile/Felt
 60 Unit, Polybag
 210 mm x 140 mm x 15 mm



09494 Notebook „Cork“

Pure nature. Very hand-friendly notebook with cork cover incl. black rubber strap for closing. Format DIN A5, 80 sheets chequered, incl. bookmark.

Piece(s)	1	100	500	1000
EUR	5.95	5.32	4.48	4.18

Wood/Cork
 40 Unit, Polybag
 210 mm x 140 mm x 20 mm

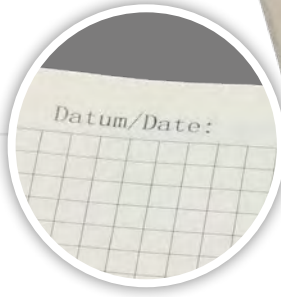

06113 Notebook „Cotton“ A4

It is trendy to be natural. Cool notebook with cotton (70 %) and polyester (30 %) binding including a elastic closure. Size DIN A4, 96 sheets (70 g) of natural-coloured paper, squared with date/ date imprint and narrow border all around. Also with band as bookmark.

Piece(s)	1	100	500	1000
EUR	5.80	5.19	4.37	4.08

Paper/Cardboard 20 Unit, Bulk
 297 mm x 210 mm x 15 mm

06115 Notebook „Cotton“ A6

Piece(s)	1	500	1000	5000
EUR	1.75	1.56	1.32	1.23

06114 Notebook „Cotton“ A5

Piece(s)	1	100	500	1000
EUR	3.46	3.09	2.61	2.43

06115 148 mm x 105 mm x 15 mm 100 Unit, Bulk
06114 210 mm x 148 mm x 15 mm 50 Unit, Bulk

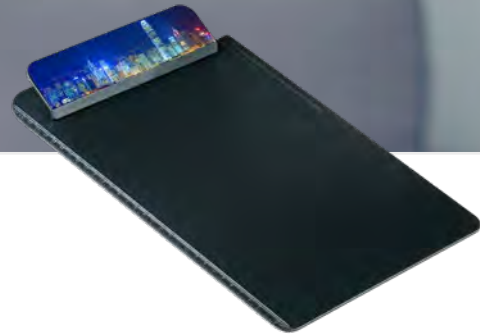

04431 Message board „DIN A4 black“

DIN A4 clipboard with alignment rule, groove for pen, scale and clamp with metal spring. Supplied without accessories. Made of recycled material.

Piece(s)	1	100	500	1000
EUR	4.59	4.11	3.46	3.23

Plastic/Polystyrene 35 Unit, Bulk
 340 mm x 240 mm x 29 mm



04435 Message board „DIN A4 colour“

DIN A4 clipboard with alignment rule, clamp with metal spring, business card holder above clamp, groove for pen and scale. Supplied without accessories.

Piece(s)	1	100	500	1000
EUR	5.42	4.85	4.09	3.81

Plastic/Polystyrene 35 Unit, Bulk
 342 mm x 240 mm x 31 mm



04428 Message board „DIN A5“

DIN A5 clipboard with alignment rule, groove for pen, scale and clamp with metal spring.

Piece(s)	1	100	500	1000
EUR	3.13	2.80	2.36	2.20

Plastic/Polystyrene 30 Unit, Bulk
 270 mm x 177 mm x 28 mm



08746 Business card holder „Vita“

Landscape format business card holder with a small silver metal plate for laser engraving as an enhancement. A magnet allows for the simple opening and closing of the cover. Imitation leather look on the outside, aluminium on the inside and velvet on the cover.

Piece(s)	1	100	500	1000
EUR	3.13	2.80	2.36	2.20

Metal/Aluminium 200 Unit, Individual carton + Polybag
 65 mm x 95 mm x 10 mm

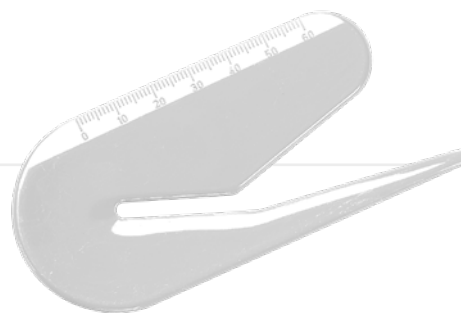

04256 Paper knife „Kombi“

Practical and handy paper knife with integrated 6cm ruler.

Piece(s)	1	500	1000	5000
EUR	0.46	0.41	0.35	0.33

Plastic/Polystyrene 500 Unit, Bulk
 110 mm x 50 mm x 3 mm



04222 Paper knife „Multi“

Paper knife in cheque card format with round and line magnifying glass and ruler with 10cm and 4 inch scale.

Piece(s)	1	500	1000	5000	
EUR	1.15	1.03	0.87	0.81	

Plastic/Polystyrene 320 Unit, Bulk
 120 mm x 75 mm x 3 mm



04218 Magnifying glass „Bookmark“

Practical pair. Flat magnifying glass which can be used as a bookmark.

Piece(s)	1	500	1000	5000	
EUR	0.21	0.19	0.16	0.15	

Plastic/Polystyrene 2000 Unit, Bulk
 80 mm x 36 mm x 2 mm

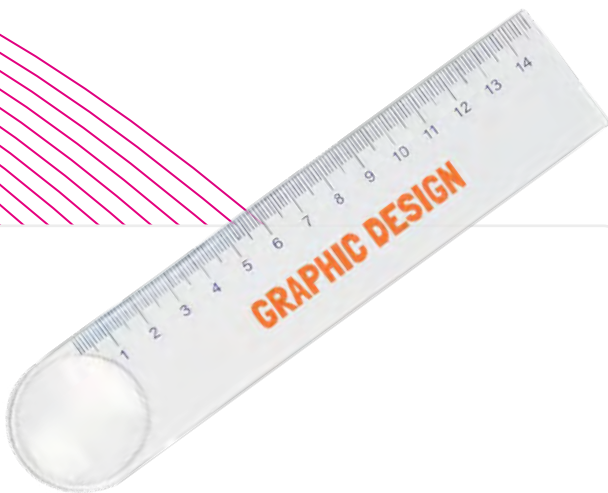

04273 Magnifying glass „Ruler 4 x“

Measure and magnify. 14cm ruler with integrated, round magnifying glass and 4x magnification.

Piece(s)	1	100	500	1000	
EUR	3.81	3.41	2.87	2.68	

Plastic/Polymethyl methacrylate 200 Unit, Polybag
 180 mm x 39 mm x 2 mm



04217 Magnifying glass „Slide“

Very handy and well protected. Handy folding magnifying glass with coloured case.

Piece(s)	1	500	1000	5000	
EUR	0.68	0.61	0.52	0.48	

Plastic/Polystyrene 500 Unit, Bulk
 9 mm x Ø 50 mm



04267 Magnifying glass „Double 3 x/6 x“

2 magnifying glass with 3x and 6x magnification. Lens aperture 23x23mm, weight 26g, sight field: 50x55mm = 3x, 25x25mm = 6x.

Piece(s)	1	100	500	1000	
EUR	5.01	4.48	3.77	3.52	

Plastic/Polymethyl methacrylate 370 Unit, Individual carton
 82 mm x 35 mm x 13 mm



04271 Magnifying glass „Measurement 10 x“

Upright magnifying glass with binocular look. 10x magnification, 17mm lens aperture, 15mm sight field, 25g weight.

Piece(s)	1	50	250	500	
EUR	12.27	10.98	9.25	8.63	

Plastic/Polymethyl methacrylate 200 Unit, Individual carton
 44 mm x 35 mm x 40 mm



04023 Upright magnifying glass „Box“

Practical magnifying glass with 4cm measuring scale in bottom. Simply place on the image you wish to magnify. No need to hold in place.

Piece(s)	1	100	500	1000	
EUR	6.62	5.92	4.99	4.66	

Plastic/Polystyrene 30 Unit, Bulk
 82 mm x Ø 79 mm



04026 Upright magnifying glass „Jupiter 2“

Magnifying glass with 5x magnification, coloured rim and 4cm measuring scale in bottom. No need to hold in place.

Piece(s)	1	50	250	500	
EUR	12.83	11.48	9.67	9.02	

Plastic/Polymethyl methacrylate 45 Unit, Individual carton + Polybag
 61 mm x Ø 72 mm



04278 Magnifying glass with handle „Handle 3 x“

Stable plastic magnifying glass, 50mm diameter, 3x magnification, handle for easy holding.

Piece(s)	1	100	500	1000	EUR
EUR	6.37	5.70	4.80	4.48	

Plastic/Polymethyl methacrylate
147 mm x 62 mm x 9 mm

100 Unit, Individual carton + Polybag



04277 Magnifying glass with handle „Handle 5 x“

Piece(s)	1	500	1000	5000	EUR
EUR	1.78	1.60	1.35	1.26	

04279 Magnifying glass with handle „Handle 4 x“

Piece(s)	1	100	500	1000	EUR
EUR	8.46	7.58	6.38	5.96	

04277
85 mm x 34 mm x 5 mm
800 Unit, Plastic box

04279
158 mm x 66 mm x 17 mm
200 Unit, Individual carton + Polybag



04240 Upright magnifying glass „Micro“

Stable magnifying glass with large 24mm lens aperture, 3cm sight field and just 30g weight.

Piece(s)	1	100	500	1000	EUR
EUR	8.02	7.18	6.05	5.65	

Plastic/Polymethyl methacrylate
39 mm x 39 mm x 43 mm

200 Unit, Individual carton



04233 Upright magnifying glass „Measurement 8 x“

Stable magnifying glass with large 24mm lens aperture, 8x magnification, 3cm sight field and 32g weight.

Piece(s)	1	50	250	500	EUR
EUR	11.76	10.53	8.87	8.28	

Plastic/Polymethyl methacrylate
47 mm x 40 mm x 44 mm

200 Unit, Individual carton

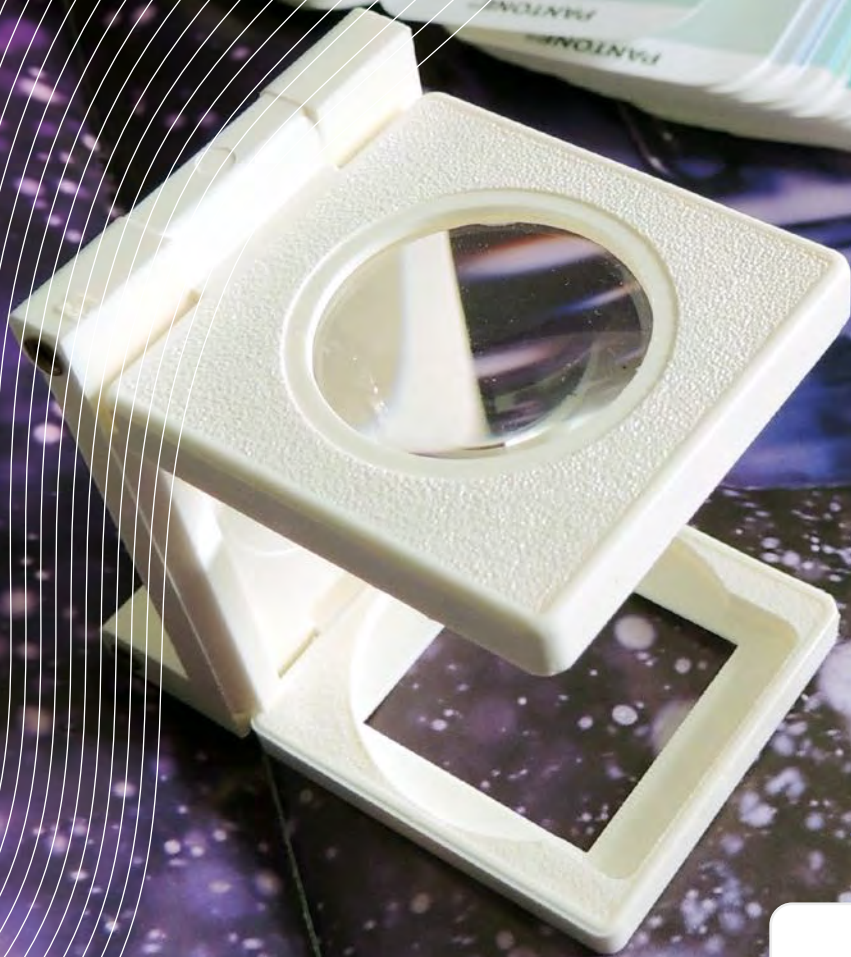



04272 Magnifying glass „Fold 5 x“

Very popular with printers. Folding upright magnifying glass with 5x magnification, 25mm lens aperture, 25x25mm sight field and 25g weight.

Piece(s)	1	100	500	1000
EUR	6.43	5.76	4.85	4.53



 Plastic/Polymethyl methacrylate

 200 Unit, Individual carton

 57 mm x 39 mm x 55 mm



04001 Magnet „Magnifying glass“

Piece(s)	1	100	500	1000	EUR
EUR	2.30	2.06	1.73	1.62	

Plastic/ABS 240 Unit, Bulk
 66 mm x 30 mm x 12 mm



08541 Film magnet „Rectangle“

Piece(s)	1	500	1000	5000	EUR
EUR	0.23	0.20	0.17	0.17	

Plastic/PVC Polybag
 33 mm x 33 mm x 2 mm



01634 Wooden magnet „Woody“

Piece(s)	1	100	500	1000	EUR
EUR	2.02	1.80	1.52	1.42	

Wood/Hazelnut wood 750 Unit, Bulk
 Ø 40 mm



04003 Magnet „Area“

Piece(s)	1	500	1000	5000	EUR
EUR	1.12	1.01	0.85	0.79	

Plastic/ABS 500 Unit, Bulk
 46 mm x 36 mm x 7 mm



04009 Magnet „Triangle“

Piece(s)	1	500	1000	5000	EUR
EUR	1.08	0.97	0.82	0.76	

Plastic/ABS 500 Unit, Bulk
 53 mm x 53 mm x 7 mm



04307 Magnet „Clapper board“

Piece(s)	1	500	1000	5000	EUR
EUR	0.74	0.66	0.56	0.52	

Plastic/ABS 500 Unit, Bulk
 55 mm x 40 mm x 6 mm



04013 Magnet „Head“

Piece(s)	1	500	1000	5000	EUR
EUR	1.04	0.93	0.79	0.73	

Plastic/ABS 500 Unit, Bulk
 49 mm x 44 mm x 7 mm



04014 Magnet „Crown cap“

Piece(s)	1	500	1000	5000	EUR
EUR	0.76	0.68	0.58	0.54	

Plastic/ABS 500 Unit, Bulk
 8 mm x Ø 29 mm



04002 Magnet „Oblong Maxi“

Piece(s)	1	500	1000	5000	
EUR	1.05	0.94	0.79	0.74	

Plastic/ABS 500 Unit, Bulk
 65 mm x 21 mm x 8 mm



04018 Magnet „Oblong Mini“

Piece(s)	1	500	1000	5000	
EUR	0.99	0.88	0.74	0.69	

Plastic/ABS 500 Unit, Bulk
 45 mm x 15 mm x 9 mm



04011 Magnet „Square“

Piece(s)	1	500	1000	5000	
EUR	0.96	0.86	0.72	0.67	

Plastic/ABS 500 Unit, Bulk
 42 mm x 42 mm x 7 mm



04006 Magnet „Square Maxi“

Piece(s)	1	500	1000	5000	
EUR	1.08	0.97	0.82	0.76	

Plastic/ABS 500 Unit, Bulk
 50 mm x 26 mm x 7 mm

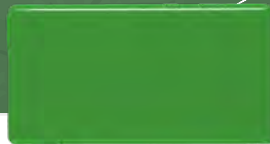

04004 Magnet „Square Mini“

Piece(s)	1	500	1000	5000	
EUR	0.93	0.83	0.70	0.65	

Plastic/ABS 500 Unit, Bulk
 37 mm x 22 mm x 7 mm



04012 Magnet „Round“

Piece(s)	1	500	1000	5000	
EUR	0.95	0.85	0.72	0.67	

Plastic/ABS 500 Unit, Bulk
 8 mm x Ø 42 mm



08840 Magnetic Clip „Fridge“

Piece(s)	1	500	1000	5000
EUR	0.50	0.44	0.41	0.39

Plastic/Polystyrene 500 Unit, Polybag
 30 mm x Ø 60 mm

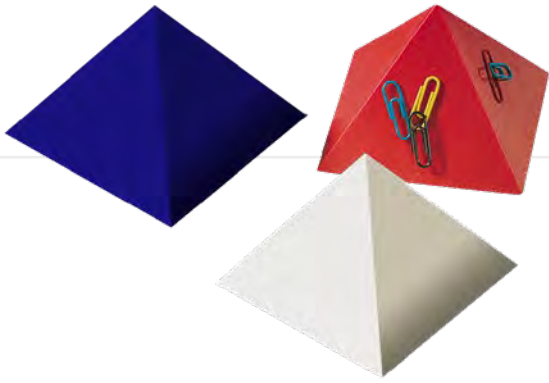

04438 Paper clip holder „Magnet Pyramid“

The magnetic points on the inside keep the paper clips magically attracted to the pyramid. Supplied with 50, colourful, plastic coated paper clips.

Piece(s)	1	100	500	1000
EUR	4.01	3.59	3.02	2.82

Plastic/Polystyrene
 97 mm x 97 mm x 69 mm

50 Unit, Individual carton + Polybag



04293 Desk organiser „Clapper board“

And action! ... let the show begin. Practical office utensil in the shape of a clapper board. Paper and pencils on request.

Piece(s)	1	100	500	1000
EUR	5.81	5.20	4.38	4.09

Plastic/ABS
 153 mm x 40 mm x 85 mm

28 Unit, Individual carton + Polybag



04280 Desk organiser „Pen holder“

Practical on any desk. Note box with 3 extra compartments for keeping pens and other writing implements. Filled with environmentally friendly recycling paper.

Piece(s)	1	100	500	1000	
EUR	5.17	4.63	3.90	3.64	

Plastic/Polystyrene
 106 mm x 106 mm x 68 mm

27 Unit, Shrink-wrap



04285 Note Box „Cube“

Classic. Unobtrusive and purpose-built plastic box, filled with environmentally friendly recycling paper. Offers large advertising space.

Piece(s)	1	100	500	1000	
EUR	7.29	6.52	5.50	5.13	

Plastic/Polystyrene
 100 mm x 100 mm x 100 mm

27 Unit, Shrink-wrap



06979 Case „Felt“

For old and young. Roomy zippered pocket for pens and other accessories. Tear-resistant and stable.

Piece(s)	1	100	500	1000
EUR	3.00	2.69	2.27	2.11

Textile/Felt 250 Unit, Polybag
 230 mm x 110 mm x 55 mm



SALE!

01203 Pencil case „Nino“

Beautiful pencil case with zip. This matches the colour of the loop sewn onto the side. The robust polyester with a herringbone pattern enables long-term use and the simple transportation of pointed pencils, without leaving holes in the fabric.

Piece(s)	1	500	1000	5000
EUR	1.03	0.92	0.77	0.72

Textile/Polyester 500 Unit, Bulk
 100 mm x 220 mm x 5 mm



05257 Storage box „Hold-all“ empty

Round collectors box made of quality acrylic material with chamfered edge. Transparent or coloured and individually fillable. Supplied without content.

Piece(s)	1	100	500	1000	
EUR	8.46	7.58	6.38	5.96	

Plastic/Polystyrene 16 Unit, Polybag
 217 mm x Ø 145 mm



04216 Paper clip „Heart“

Light, flat note clamp in the shape of a heart. Perfect for mail shots and as a give-away.

Piece(s)	1	500	1000	5000	
EUR	0.21	0.19	0.16	0.15	

Plastic/Polystyrene 2000 Unit, Bulk
 59 mm x 46 mm x 1 mm



08964 Mouse pad „Microfiber“

This mouse pad is flexible and skid-proof and convinces furthermore with a big advertising surface. The top side is completely realized in 4 colours and can be individually customized. On the bottom side the special anti-skid coating prevents slipping when the computer mouse is being used. Furthermore, the top surface can be used as a microfiber cloth for cleaning the screen or other items.

Piece(s)	1	100	500	1000
EUR	2.27	2.03	1.71	1.60

Textile/Polyester + Polyamide 1000 Unit, Polybag
 230 mm x 175 mm

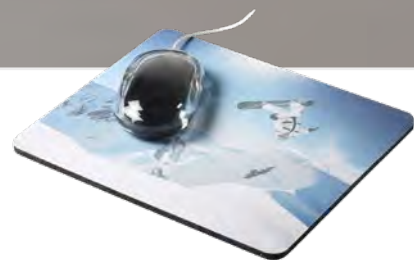

01137 Mousepad „Subli“

Mousepad designed to your taste. 100 % polyester fabric on 3mm soft rubber mat makes this mousepad really comfortable and hard-wearing. 4c Sublimation finishing possible for your custom design.

Piece(s)	1	100	500	1000
EUR	2.19	1.96	1.65	1.54

Textile/Polyester 160 Unit, Bulk
 234 mm x 195 mm x 3 mm

Lifestyle and Accessories.

- *Displaycleaner*
- *Shopping trolley chips and deposit*
- *Mobile accessories*
- *Pins and buttons*
- *Key fob*
- *Sunglasses*
- *Economy and storage boxes*
- *Mirror*
- *other accessories*





01623 Sunglasses „Beach“, clean-up

Wear sunglasses and clean up the oceans at the same time! On-trend sunglasses that also do the environment a favour! For each pair of sunglasses purchased, the Honu Movement fishes 2 PET bottles from the ocean. The lenses offer UV-400 protection. Meets the requirements of EU Regulation 2016/425 PPE, category 1 and standard EN ISO 12312-1:2013+A1:2015 (DIN EN ISO 12312-1:2015-12).

Piece(s)	1	100	500	1000	
EUR	3.51	3.14	2.96	2.79	

Plastic/ABS + PC

180 Unit, Individual carton

150 mm x 147 mm x 49 mm

1. Wear sunglasses.
2. Clean the ocean.

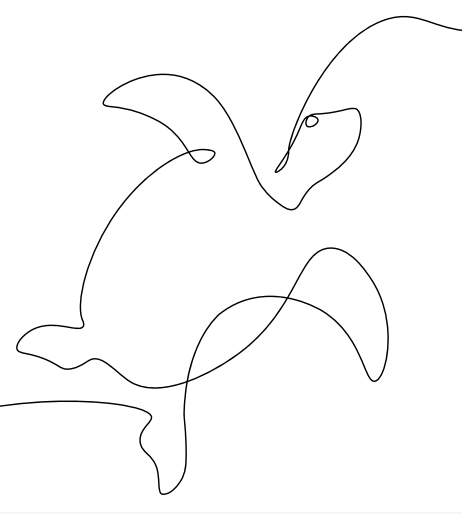

For every pair of "Beach" sunglasses, employees of The Honu Movement collect and recycle 2 waste single-use plastic bottles from the ocean.



CERTIFIED PARTNER
PFP-202268



Quality
Made in
Germany.

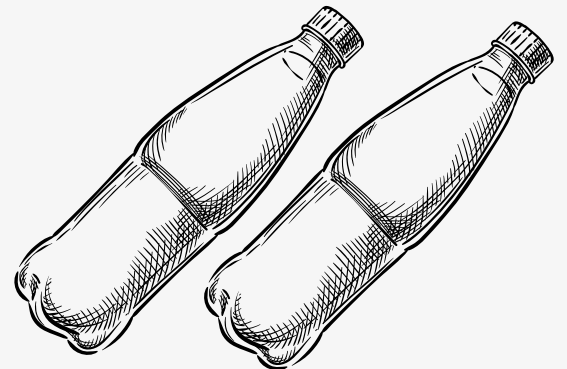
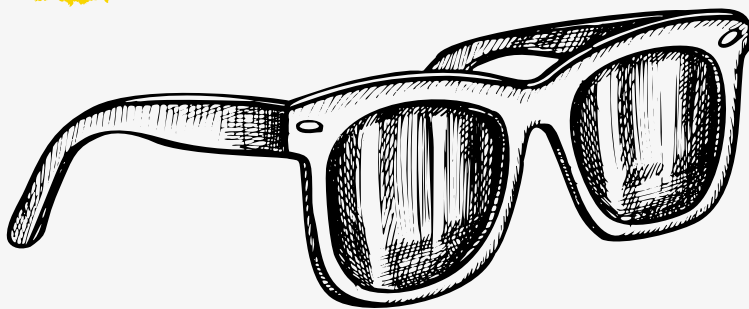

01623 Sunglasses
"Beach" clean-up



2 waste single-use plastic
bottles from the ocean.

What The Honu Movement is all about...



Removing plastic.

We employ our own staff to collect plastic from the ocean.



Reusing plastic.

We process the collected plastic using certified local recycling systems.



Avoiding plastic.

Dedicated teachers teach children about sustainable lifestyle.



Combatting poverty.



We provide fair jobs for the poorest of the poor.



07878 Sunglasses „Blues“

Iconic sunglasses in blues style. Available in different colours. The frame is made of lightweight PC. The black tinted lenses are acrylic with UV-400 protection. Light and comfortable to wear. Complies with requirements of EU directive 2016/425 and standard EN ISO 12312-1. Filter category 3, Class I.

Piece(s)	1	100	500	1000
EUR	2.06	1.85	1.55	1.45



 Plastic/Polycarbonate
  300 Unit, Polybag
 145 mm x 150 mm x 48 mm



08080 Sunglasses „Blues“ ocean

Iconic sunglasses in blues style. Frame colour available in black, white or transparent. The frame is made of lightweight PC. The tinted lenses are acrylic with UV-400 protection. Specially mirrored blue foil creates the unique effect. Light and comfortable to wear. Complies with requirements of EU directive 2016/425 and standard EN ISO 12312-1. Filter category 3, Class I.

Piece(s)	1	100	500	1000
EUR	2.87	2.57	2.17	2.02



 Plastic/Polycarbonate
  300 Unit, Polybag
 145 mm x 150 mm x 48 mm



08081 Sunglasses „Blues“ sun

Iconic sunglasses in blues style. Frame colour available in black, white or transparent. The frame is made of lightweight PC. The tinted lenses are acrylic with UV-400 protection. Specially mirrored, yellow/orange foil creates the unique effect. Light and comfortable to wear. Complies with requirements of EU directive 2016/425 and standard EN ISO 12312-1. Filter category 3, Class I.

Piece(s)	1	100	500	1000
EUR	3.43	3.07	2.59	2.42



 Plastic/Polycarbonate
  300 Unit, Polybag
 145 mm x 150 mm x 50 mm



07757 Sunglasses „Bamboo“

Really stylish. Fashionable sunglasses in blues style with real bamboo temples and a delicately structured frame of black PC. The black tinted lenses are acrylic with UV-400 protection. Light and comfortable to wear. Complies with requirements of EU directive 2016/425 and standard EN ISO 12312-1. Filter category 3, Class I.

Piece(s)	1	50	250	500
EUR	10.30	9.22	7.77	7.25



 Wood/Bamboo
  400 Unit, Polybag
 135 mm x 160 mm x 50 mm



01277 Sunglasses „Sunshine“

Stylish sunglasses for your ad campaign. Frame colour available in black or white. The frame is lightweight PC. The tinted glasses are also acrylic and have UV-400 protection level. The specially mirrored blue foil creates the special effect. Light and comfortable to wear. Complies with requirements of EU Act 2016/425, Class 1 and Standard EN ISO 12312-1. Filter category 3.

Piece(s)	1	100	500	1000
EUR	2.38	2.13	1.80	1.68

 Plastic/Polycarbonate
  300 Unit, Polybag

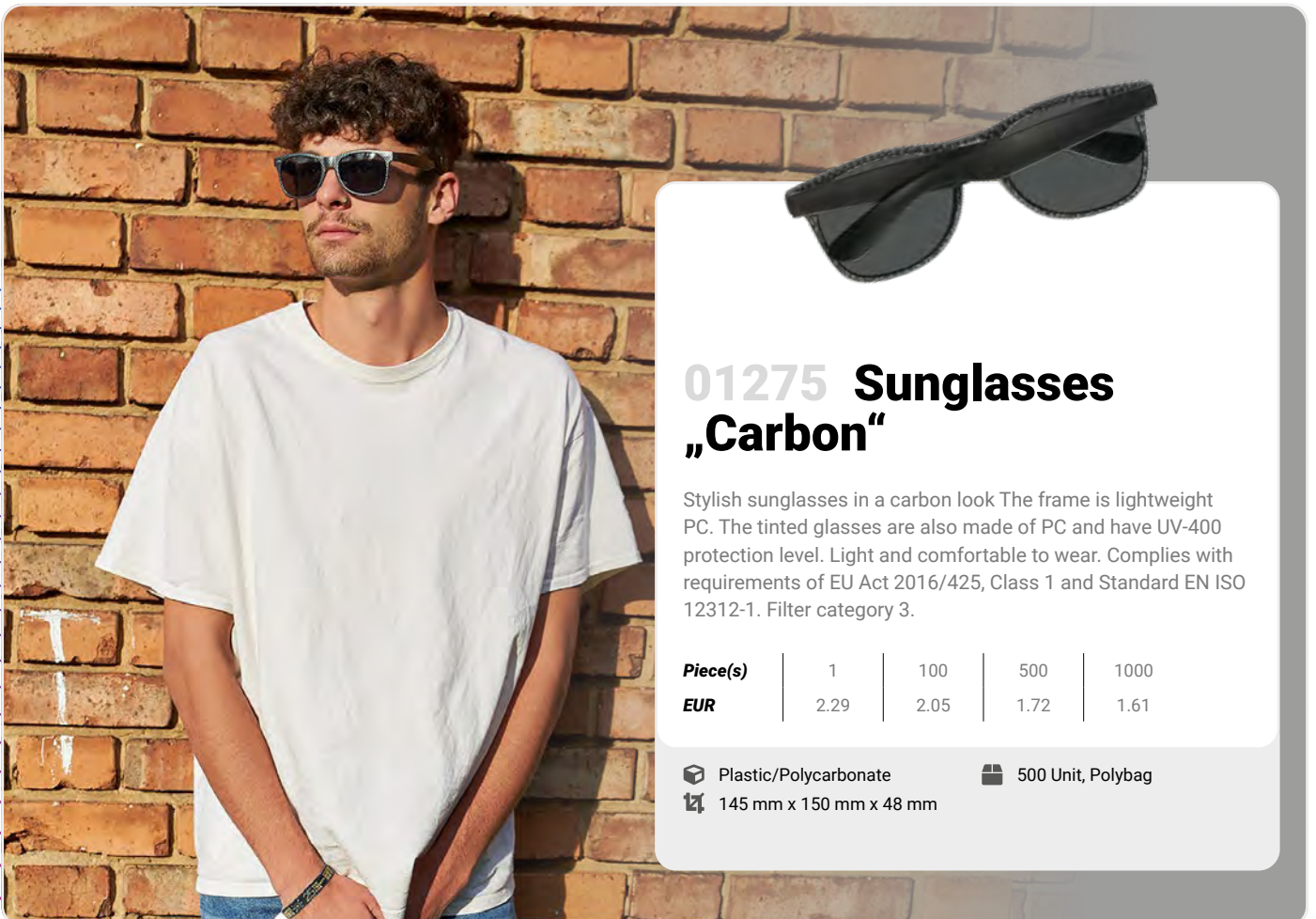

 145 mm x 150 mm x 48 mm



01275 Sunglasses „Carbon“

Stylish sunglasses in a carbon look. The frame is lightweight PC. The tinted glasses are also made of PC and have UV-400 protection level. Light and comfortable to wear. Complies with requirements of EU Act 2016/425, Class 1 and Standard EN ISO 12312-1. Filter category 3.

Piece(s)	1	100	500	1000
EUR	2.29	2.05	1.72	1.61

 Plastic/Polycarbonate
  500 Unit, Polybag

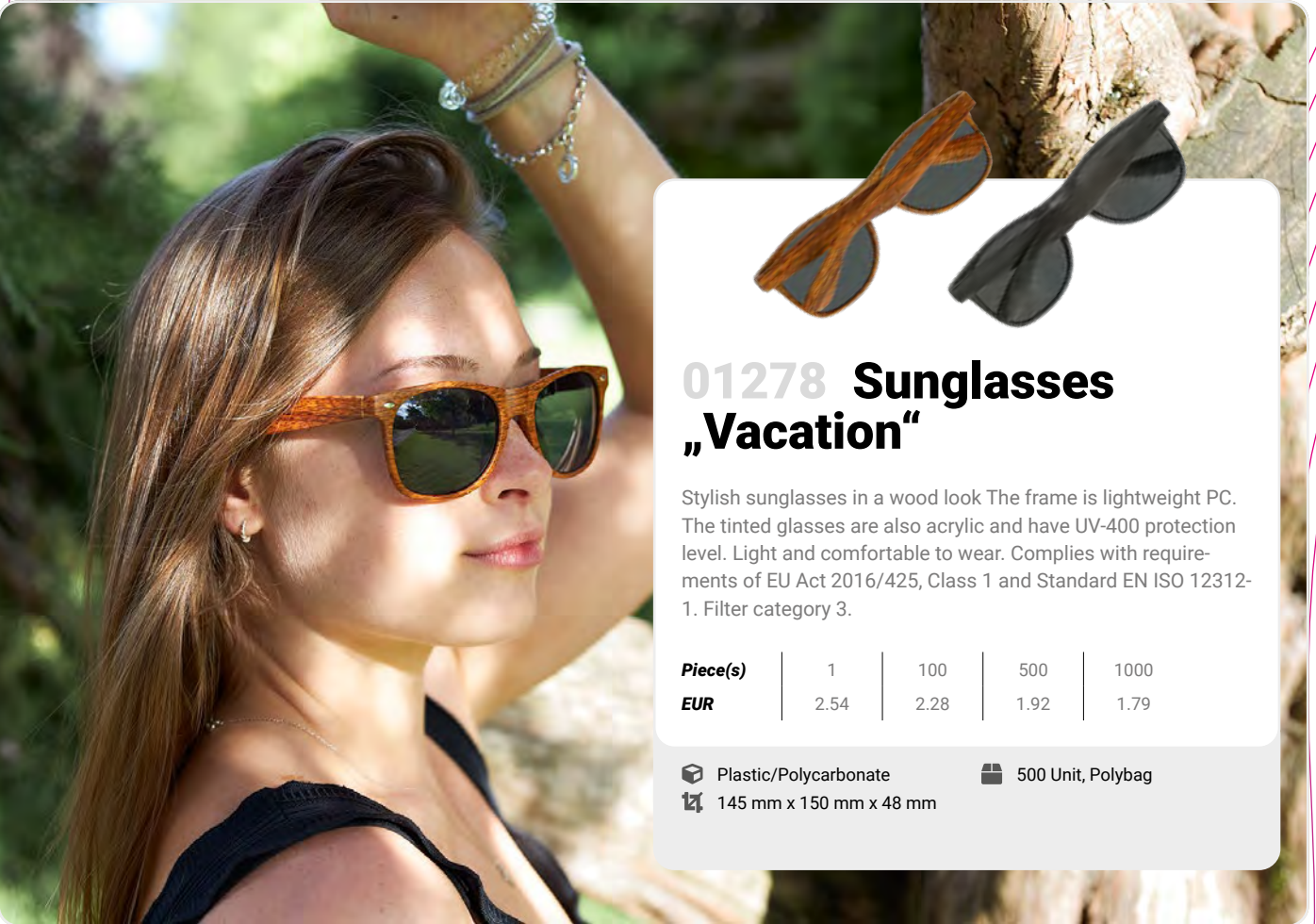

 145 mm x 150 mm x 48 mm



01278 Sunglasses „Vacation“

Stylish sunglasses in a wood look. The frame is lightweight PC. The tinted glasses are also acrylic and have UV-400 protection level. Light and comfortable to wear. Complies with requirements of EU Act 2016/425, Class 1 and Standard EN ISO 12312-1. Filter category 3.

Piece(s)	1	100	500	1000
EUR	2.54	2.28	1.92	1.79

 Plastic/Polycarbonate
  500 Unit, Polybag



 145 mm x 150 mm x 48 mm



01279 Sunglasses „Verano“

Stylish sunglasses with just one large eyeglass lens. The frame is lightweight PC. The silver mirrored glass is also made of PC. The glasses have UV-400 protection level. Light and comfortable to wear. Complies with requirements of EU Act 2016/425, Class 1 and Standard EN ISO 12312-1. Filter category 3.

Piece(s)	1	100	500	1000
EUR	2.83	2.54	2.14	1.99

 Plastic/Polycarbonate
  500 Unit, Polybag

 145 mm x 150 mm x 48 mm



07877 Fun glasses „Bavaria“

To give your spirits a lift... cool fun glasses with PC frames with a white-blue diamond pattern. Light and pleasant to wear. The lenses have a light blue tint.

Piece(s)	1	100	500	1000
EUR	2.55	2.28	1.92	1.79

- Plastic/Polycarbonate
- 300 Unit, Polybag
- 145 mm x 150 mm x 50 mm
- Fan items



01460 Safety Goggle Strap

Practical nylon safety goggle strip for the 01430 Safety Goggles, featuring a cord stopper for simple length adjustment. The strap is attached by pulling both sides over the ends of the safety goggles. It is incredibly easy, yet still provides a secure hold. Goggles not included.

Piece(s)	1	500	1000	5000
EUR	1.09	0.97	0.82	0.76

- Plastic/Nylon
- 1000 Unit, Polybag
- 590 mm x 10 mm



01462 Glasses pouch „Textile“

Practical protective pouch for your glasses. The polyester pouch protects glasses from scratches and wear-and-tear. With double-sided drawstring fastening.

Piece(s)	1	500	1000	5000
EUR	1.03	0.92	0.77	0.72

- Plastic/Polyester
- 1000 Unit, Bulk
- 200 mm x 115 mm



04810 Glasses case „B-Box“

Well kept. Stable plastic box for glasses, sunglasses, or even crayons. With snap fastener.

Piece(s)	1	500	1000	5000
EUR	1.46	1.30	1.10	1.03

- Plastic/Polypropylene
- 120 Unit, Bulk
- 160 mm x 65 mm x 50 mm

SALE!

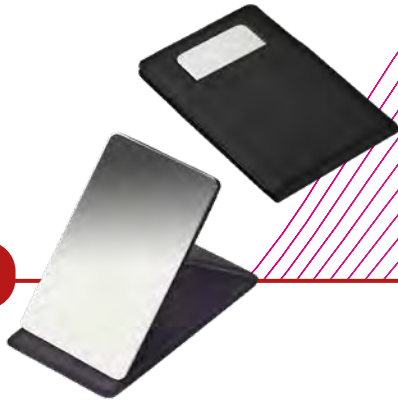

07426 Pocket mirror „Fold-Out“

Elegant accessory for being on the road and for any handbag. Foldable and placeable hand mirror, made of a thin, polished iron plate in, in synthetic leather case with suede coating on the inside and a magnetic clasp. Furthermore, the outside features an integrated stainless steel platelet in trendy gun grey. The mirror is break-proof and therefore ideal for travels.

Piece(s)	1	100	500	1000
EUR	1.97	1.77	1.49	1.39

Plastic/Artificial leather 200 Unit, Individual carton + Polybag
 90 mm x 55 mm x 4 mm



01081 Fan „Calor“

Perfect for hot days. Folding polyester fan with case for occasional cooling off.

Piece(s)	1	500	1000	5000
EUR	0.69	0.62	0.52	0.49

Textile/Polyester 210D 500 Unit, Polybag
 315 mm x 220 mm Fan items



02310 Fan „Cloud“

For you to create fresh advertising messages. Manufactured from plastic compartments in the form of clouds with large advertising space.

Piece(s)	1	500	1000	5000	
EUR	0.87	0.78	0.66	0.61	

Plastic/Polystyrene 200 Unit, Bulk
 242 mm x 194 mm x 3 mm



02320 Fan „Heart“

For romantic messages. Heart-shaped fan made of robust plastic

Piece(s)	1	500	1000	5000	
EUR	0.94	0.85	0.71	0.67	

Plastic/Polystyrene 200 Unit, Bulk
 235 mm x 184 mm x 3 mm



04072 Cigarette box „Zig-Box“

This clever gadget protects your cigarette pack against squashing and breaking as well as against the scary photos on the pack. Simple and highly functional plastic holder for cigarettes including a hinged lid. Proved for a big advertising space.

Piece(s)	1	500	1000	5000	EUR
EUR	0.86	0.77	0.65	0.60	

Plastic/Polypropylene 112 Unit, Bulk
65 mm x 28 mm x 95 mm

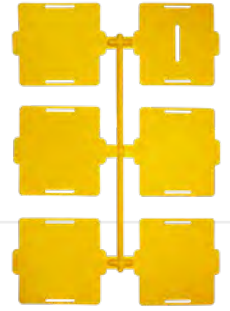

03770 Savings box „Self-Made“

Perfect as an on-pack. This flat DIN A4 format savings jar is designed for easy assembly. Large advertising spaces on up to 6 sides of the cube.

Piece(s)	1	500	1000	5000	GER
EUR	1.66	1.48	1.25	1.17	

Plastic/Polystyrene 100 Unit, Bulk
80 mm x 80 mm x 80 mm

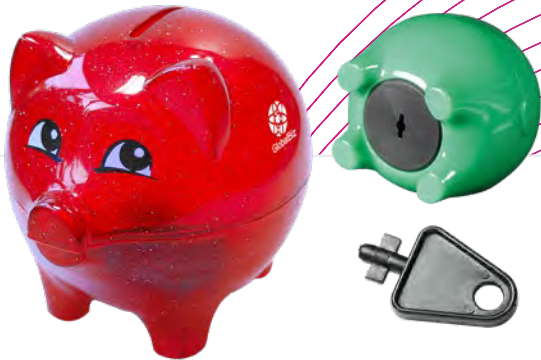

03771 Savings box „Piggy“

Cute plastic piggy with print-on eyes, slot for coins, closable lid and matching key.

Piece(s)	1	100	500	1000
EUR	2.89	2.59	2.18	2.04

Plastic/Polystyrene 60 Unit, Bulk
115 mm x 95 mm x 100 mm

SALE!



06093 Savings box „Sweet Home“

The new building society box. Drop in a few coins every day and your dream of a new home will come closer. Savings box made of hard plastic. Ideal for banks. With twist-on lid underneath.

Piece(s)	1	100	500	1000
EUR	2.00	1.79	1.52	1.42

Plastic/Polystyrene 60 Unit, Individual carton + Polybag
100 mm x 85 mm x 90 mm



08693 VR glasses „Cardboard“

Enter the virtual world. With this cardboard you can experience virtual movies, games, 360° pictures and museum tours via free apps. Just put the smartphone inside the set up cardboard glasses, close the lid using the hook and loop fastener and fix it to the head by means of the flexible strap. Suitable for all standard smartphones with a display of 5.5".

Piece(s)	1	100	500	1000
EUR	3.02	2.71	2.28	2.13

Paper/Cardboard 100 Unit, Polybag
 136 mm x 90 mm x 80 mm

SALE!



08695 VR glasses „Cyber“

High-quality VR glasses with stable distance and lens control as well as elastic headbands that can be adapted to any head size by the hook-and-loop fastener. The padded face foam offers a pleasing wearing comfort even in case of longer usage. Suitable for most smartphones. The front cover offers a large printable area of 16 x 6.5 cm and is securely attached to the glasses by means of magnets.

Piece(s)	1	50	250	500
EUR	7.85	7.71	7.42	7.28

Plastic/ABS 20 Unit, Individual carton + Polybag
 203 mm x 147 mm x 113 mm



03031 Mobile phone dock „PowerPort Holder“

Mobile phone charger dock consisting of base and mount. 5 different mounts available (oval, round, rectangular, square, and hand).

Piece(s)	1	500	1000	5000
EUR	1.64	1.47	1.24	1.16

Plastic/Polystyrene 200 Unit, Polybag
 165 mm x 105 mm



SALE!



08633 Mobile holder „Curved“

An elegant piece. Design mobile phone holder made from plastics with pedestal and hole on the rear for passing through a charging cable. The advertising space is placed optimally as it is always in the user's field of vision.

Piece(s)	1	500	1000	5000
EUR	0.60	0.53	0.45	0.42



 Plastic/Polystyrene  250 Unit, Polybag
 55 mm x 50 mm x 65 mm



01629 Smartphone holder „Woody“

Holds your smartphone securely in place on your desk, in the office or on your bedside table. View photos and videos, make Skype calls, film yourself, read cooking recipes - with this birchwood holder for your desk you can view everything at the perfect angle.

Piece(s)	1	100	500	1000
EUR	1.99	1.78	1.50	1.40

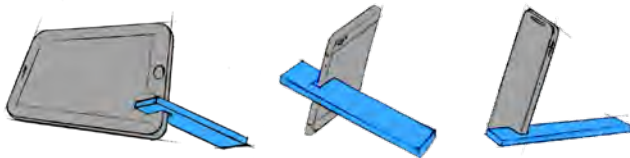

 Wood/Birch wood  240 Unit, Bulk
 70 mm x 140 mm



01431 Mobile device holder „Upprett“

Holds your smartphone or tablet computer securely in place on your desk, in the office or on your bedside table. View videos or photos, make Skype calls, film yourself, read cooking recipes - with this handy and minimalistic holder for your table, you can do all this and more - and always with the correct viewing angle. Position your mobile device exactly how you need it. Suitable for devices with a depth of up to 1.0 cm.

Piece(s)	1	500	1000	5000
EUR	2.40	2.33	2.25	2.14

 Plastic/ABS  100 Unit, Folding card
 160 mm x 30 mm x 6 mm





06844 Bag „Waterproof Smartphone“

Protects against external influences. With zip and hook-and-loop fastener. Perfect for the beach, outings or holidays.

Piece(s)	1	500	1000	5000
EUR	2.16	1.93	1.62	1.50

Plastic/PVC

200 Unit, Polybag

230 mm x 95 mm x 2 mm



06434 Smartphone gloves „Touch“

No more cold hands when using your smartphone and the like. Touch gloves with capacitive material incorporated into the tips of the thumb, index and middle fingers. 83 % polyacrylic, 7 % polyurethane, 5 % elastane and 5 % metal fibre. Ideal for smartphones and tablet PCs.

Piece(s)	1	100	500	1000
EUR	3.00	2.69	2.26	2.11

Plastic/Polyacrylic

345 Unit, Polybag

230 mm x 120 mm



03792 Badge „Colour-Clip“

Unobtrusive. Large, round clip for clamping with 55mm advertising space on front and clamp on rear side.

Piece(s)	1	500	1000	5000	
EUR	0.36	0.32	0.27	0.25	

Plastic/Polystyrene

1000 Unit, Bulk

9 mm x Ø 55 mm

NEW!



01678 Plastic chip „40mm“

Attractive plastic chip with versatile options for use. Use as poker chips, tokens for board games or card games, deposit tokens or as a mathematical learning aid for children - these chips are always the perfect choice.

Piece(s)	1	500	1000	5000	
EUR	0.14	0.13	0.11	0.10	

Plastic/ABS

2000 Unit, Bulk

Ø 40 mm



01491 Key fob „Safe contact“

Perfectly suitable for contactless operation of light switches, PIN pads, cash machines, or opening doors. This key fob can easily be attached to your keyring, ensuring that it is always on hand and ready for use. Reusable, as it can be cleaned with detergent and even disinfectant.

Piece(s)	1	500	1000	5000	
EUR	0.57	0.51	0.43	0.40	

Plastic/Polystyrene 250 Unit, Bulk
 100 mm x 50 mm x 3 mm



01499 Key fob „Safe contact“ with key ring

Piece(s)	1	500	1000	5000
EUR	0.75	0.67	0.56	0.53

Plastic/Polystyrene 200 Unit, Bulk
 100 mm x 50 mm



SALE!

01461 Shopping Trolley Protection Kit

Practical set of neoprene grips that protect your hand against direct contact with the handle of a shopping trolley. The 4 cm-wide hook and loop fastening makes them easy to apply. The neoprene offers its users a comfortable feel. Set contains 2 pieces.

Piece(s)	1	100	500	1000
EUR	2.62	2.35	1.97	1.84

Plastic/Rubber 16 Unit, Polybag
 160 mm x 130 mm

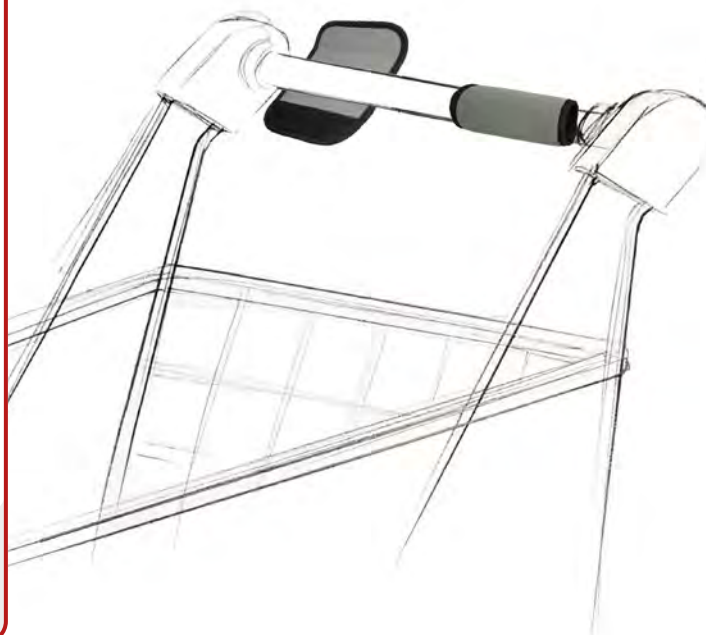



01155 Keyring „Rectangle“

Key fob made of transparent plastic. Square shape, including keyring.

Piece(s)	1	500	1000	5000
EUR	0.55	0.49	0.42	0.39

Plastic/Polystyrene
 1000 Unit, Bulk
 50 mm x 20 mm x 4 mm



01156 Keyring „Round“

Key fob made of slightly transparent plastic with matte finish. Round shape with football look, including keyring.

Piece(s)	1	500	1000	5000
EUR	0.55	0.49	0.42	0.39

Plastic/Polystyrene
 1000 Unit, Bulk
 3 mm x Ø 35 mm



01157 Keyring „Angel“

Key fob made of slightly transparent plastic with matte finish. Shaped like an angel, including keyring.

Piece(s)	1	500	1000	5000
EUR	0.55	0.49	0.42	0.39

Plastic/Polystyrene
 1000 Unit, Bulk
 42 mm x 43 mm x 3 mm



01158 Keyring „Heart“

Key fob made of transparent plastic. Heart shaped including keyring.

Piece(s)	1	500	1000	5000
EUR	0.55	0.49	0.42	0.39

Plastic/Polystyrene
 1000 Unit, Bulk
 40 mm x 42 mm x 3 mm



07945 Keyring „Inlay 35*24“

Handy. Transparent key fob, rectangular shape with keyring. Logo possible as customisable paper insert.

Piece(s)	1	500	1000	5000
EUR	0.82	0.72	0.60	0.56

📦 Plastic 📦 1500 Unit, Bulk
 📏 47 mm x 30 mm x 6 mm



08910 Keyring „Rectangle“

Classic, square key fob with metal ring. Logo possible as customisable paper insert. Inserts on request. The compartment for the insert can be opened using a coin.

Piece(s)	1	500	1000	5000
EUR	1.00	0.90	0.74	0.69

📦 Plastic 📦 1000 Unit, Bulk
 📏 57 mm x 37 mm



04295 Keyring „Mini clapper board“

And action! ... let the show begin. Small key fob in clapperboard design.

Piece(s)	1	500	1000	5000	🏆 EUR
EUR	0.67	0.60	0.51	0.47	

📦 Plastic/ABS 📦 1000 Unit, Bulk
 📏 45 mm x 30 mm x 4 mm



04297 Keyring „Magnifying glass clapper board“

And action! ... let the show begin. Key fob shaped like a clapperboard with 5x fold-out magnifying glass.

Piece(s)	1	100	500	1000
EUR	2.61	2.34	1.97	1.84

📦 Plastic 📦 1000 Unit, Bulk
 📏 56 mm x 36 mm x 7 mm



04035 Keyring „Police stop“

Attention guaranteed. Available as police stop, fire service stop, border patrol stop versions. With keyring.

Piece(s)	1	500	1000	5000	
EUR	1.06	0.95	0.80	0.74	

Plastic 1500 Unit, Bulk
 70 mm x 30 mm x 8 mm



SALE!

01016 Key fob „Care“

Practical keychain with integrated manicure set. The set includes a nail clipper, a file, tweezers and a cuticle pusher. These are certainly fixed by magnets in the matching compartments in a grey sliding case. Incl. keyring for fixing.

Piece(s)	1	100	500	1000
EUR	1.54	1.37	1.16	1.09

Metal/Stainless steel 300 Unit, Individual carton + Polybag
 125 mm x 25 mm x 20 mm



09574 Key pendant „Pocket Bottle“

Mini flat man with metal carabiner.

Piece(s)	1	100	500	1000
EUR	4.24	3.80	3.20	2.98

Metal 500 Unit, Individual carton + Polybag
 105 mm x 40 mm x 20 mm



09061 Key pendant „Apartment“

Small model in the shape of the classical hotel key pendant, made of massive metal with zinc alloy and rubber ring.

Piece(s)	1	100	500	1000
EUR	3.78	3.39	2.85	2.66

Metal/Zinc 140 Unit, Gift box + Slipcase
 50 mm x Ø 20 mm



09599 Key pendant „Open“

Key pendant with opener for bottles and tins made of metal.

Piece(s)	1	500	1000	5000
EUR	1.00	0.90	0.76	0.71

Metal/Aluminium
 64 mm x 15 mm x 15 mm

600 Unit, Individual carton + Polybag



06000 Keyring „Parma“

Light as a feather and so practical. Bottle opener made of a light and stable aluminium alloy. With metal keyring.

Piece(s)	1	500	1000	5000
EUR	0.38	0.34	0.28	0.27

Metal/Aluminium
 60 mm x 7 mm x 10 mm

1500 Unit, Polybag



09063 Chip key pendant „Business“

Round chip key pendant made of matt brush-finished metal with chip for a shopping trolley.

Piece(s)	1	100	500	1000
EUR	2.16	1.94	1.63	1.52

Metal
 5 mm x Ø 35 mm

300 Unit, Polybag



SALE!

08983 Keyring pendant „Letter Opener“

Keyring pendant made from plastics incl. keyring and small integrated bottle opener. The blade features an automatic retract function to prevent injuries.

Piece(s)	1	500	1000	5000
EUR	0.51	0.46	0.39	0.36

Plastic/ABS
 70 mm x 30 mm x 7 mm

1000 Unit, Polybag



01196 Key fob „Cardiff“ oval

Showcase your style, with your keys Fantastic oval key fob made from genuine leather with a metal trim made from zinc alloy in a matt grey finish. Includes keyring, and available in brown or black.

Piece(s)	1	100	500	1000
EUR	3.13	2.80	2.36	2.20

Metal/Zinc
 65 mm x 36 mm x 5 mm

250 Unit, Individual carton + Polybag



01197 Key fob „Cardiff“ rectangular

Piece(s)	1	100	500	1000
EUR	3.55	3.18	2.68	2.50

Metal/Zinc
 65 mm x 20 mm x 5 mm

250 Unit, Individual carton + Polybag



06885 Felt pendant „Strap“

Strong and tear-proof. Trendy pendant made of two-layer felt with metal eye and metal key ring. Rugged thanks to felt layers of 2 mm each.

Piece(s)	1	500	1000	5000
EUR	0.81	0.72	0.61	0.57

Textile/Polyester-felt
 120 mm x 25 mm x 5 mm

1000 Unit, Polybag

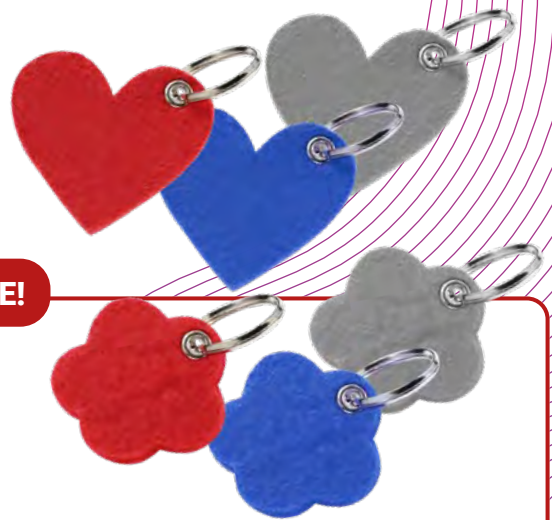

SALE!

06958 Felt pendant „Motiv“

Trendy accessory for your key ring. Heart or flower-shaped pendant made of 5mm felt, with metal eye and key ring.

Piece(s)	1	500	1000	5000
EUR	0.46	0.41	0.35	0.33

Textile/Polyester-felt
 5 mm x Ø 60 mm

2500 Unit, Polybag

SALE!



01205 Key case „Nino“

Durable key case with keyring and zip. This matches the colour of the loop sewn onto the side. The robust polyester with a herringbone pattern enables long-term use and the simple transportation of keys without leaving holes in the fabric.

Piece(s)	1	500	1000	5000
EUR	0.84	0.76	0.63	0.59

Textile/Polyester
 100 mm x 100 mm x 5 mm

500 Unit, Bulk



01145 Fan keyring „Survival“

A keyring for all football fans! Sturdy keyring made of woven nylon cord in black, red and yellow. The aluminium carabiner hook is perfectly suited for holding together even heavy keys.

Piece(s)	1	500	1000	5000
EUR	1.59	1.42	1.20	1.12

Textile/Nylon
 130 mm x 30 mm x 5 mm

500 Unit, Polybag



01638 Key ring „Cork“, rectangular

Lovely rectangular-shaped key ring made of two layers of cork with a metal ring for keys.

Piece(s)	1	500	1000	5000
EUR	1.29	1.16	0.98	0.91

Wood/Cork
 85 mm x 27 mm x 6 mm

1000 Unit, Bulk



01639 Key ring „Cork“, round

Lovely rounded key ring made of two layers of cork with a metal ring for keys.

Piece(s)	1	500	1000	5000
EUR	1.29	1.16	0.98	0.91

Wood/Cork
 75 mm x 45 mm x 6 mm x Ø 45 mm

1000 Unit, Bulk



01290 Key ring „Natura“, square

Piece(s)	1	500	1000	5000
EUR	0.57	0.51	0.43	0.40

Wood/Beech wood 1000 Unit, Bulk
 110 mm x 30 mm x 7 mm Decoration

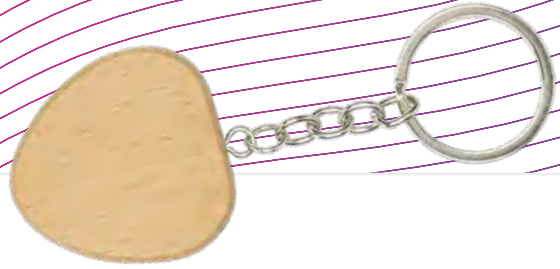

01291 Key ring „Natura“, heart

Piece(s)	1	500	1000	5000
EUR	0.62	0.56	0.47	0.44

Wood/Beech wood 1000 Unit, Bulk
 100 mm x 40 mm x 7 mm Decoration

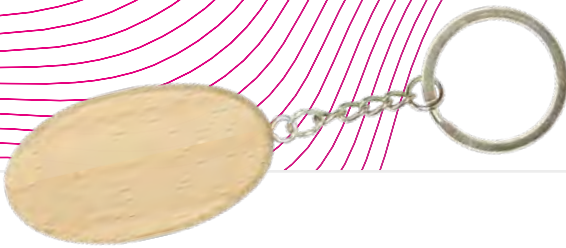

01292 Key ring „Natura“, oval

Piece(s)	1	500	1000	5000
EUR	0.57	0.51	0.43	0.40

Wood/Beech wood 1000 Unit, Bulk
 100 mm x 30 mm x 7 mm Decoration



01293 Key ring „Natura“, round

Piece(s)	1	500	1000	5000
EUR	0.57	0.51	0.43	0.40

Wood/Beech wood 1000 Unit, Bulk
 90 mm x 40 mm x 7 mm Decoration



01632 Wooden key ring „Woody“

Piece(s)	1	100	500	1000
EUR	1.91	1.71	1.44	1.34

Wood/Hazelnut wood 500 Unit, Bulk
 Ø 45 mm



01633 Square wooden key ring „Maple“

Piece(s)	1	500	1000	5000
EUR	1.62	1.45	1.22	1.14

Wood/Maple wood 500 Unit, Bulk
 100 mm x 100 mm



01643 Token-keyring „Circle“

Piece(s)	1	500	1000	5000
EUR	0.89	0.80	0.67	0.63

Wood
Ø 30 mm

3000 Unit, Bulk



01642 Token-keyring „Round“

Piece(s)	1	500	1000	5000
EUR	0.89	0.80	0.67	0.63

Wood
Ø 30 mm

3000 Unit, Bulk



01038 Token-keyring „Natural“

Piece(s)	1	500	1000	5000
EUR	0.93	0.84	0.70	0.66

Wood
43 mm x 42 mm x 5 mm

2400 Unit, Polybag



01037 Shopping trolley token „Natural“

Piece(s)	1	500	1000	5000
EUR	0.23	0.20	0.17	0.16

Wood
2 mm x Ø 23 mm

10000 Unit, Bulk



01720 Shopping trolley token „Bamboo“

Piece(s)	1	500	1000	5000
EUR	0.60	0.53	0.45	0.42

Wood/Bamboo
65 mm x 22 mm

2000 Unit, Bulk

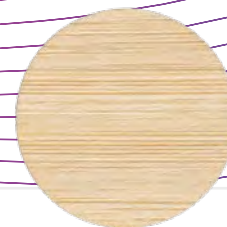

01699 Shopping trolley token „Bamboo“

Piece(s)	1	500	1000	5000
EUR	0.28	0.25	0.22	0.20

Wood/Bamboo
2 mm x Ø 23 mm

20000 Unit, Bulk



04078 Clip Chip

It is small, round and features a clip at the key ring. This great shopping trolley chip made of stable plastic can be attached at a key ring easily and in a loss-protected way. Nevertheless, it just takes a small twist to have it at your hand when you are shopping.

Piece(s)	1	500	1000	5000	
EUR	0.18	0.16	0.14	0.13	

Plastic/Polystyrene 10000 Unit, Bulk
 Ø 23 mm



04243 Shopping cart chip without hole

Shopping cart chip without keyring.

Piece(s)	1	500	1000	5000	
EUR	0.13	0.10	0.09	0.07	

Plastic/Polystyrene 10000 Unit, Bulk
 2 mm x Ø 23 mm



04249 Shopping cart chip „Anti-Tick“

A smile against ticks. This small, but effective helper removes ticks without any problems and quickly. In addition, it can be used as shopping cart chip. With a hole for key ring.

Piece(s)	1	500	1000	
EUR	0.16	0.14	0.11	

Plastic/Polystyrene 10000 Unit, Bulk
 2 mm x Ø 23 mm



04244 Shopping cart chip „1 Euro“

Shopping cart chip without keyring.

Piece(s)	1	500	1000	5000	
EUR	0.10	0.09	0.07	0.07	

Plastic/Polystyrene 10000 Unit, Bulk
 2 mm x Ø 23 mm



04123 Chip-keyhanger „Rectangular“

Light, flat and always available. Plastic keyring with shopping cart chip. Efficient advertising space.

Piece(s)	1	500	1000	5000	
EUR	0.29	0.26	0.22	0.21	

Plastic/Polystyrene 2000 Unit, Bulk
 65 mm x 30 mm x 4 mm



04127 Chip keyring „Square“

Ultra-flat. Square key fob available in a large selection of colours. Without keyring.

Piece(s)	1	500	1000	5000	
EUR	0.30	0.27	0.23	0.21	

Plastic/Polystyrene 2000 Unit, Bulk
 57 mm x 30 mm x 4 mm



04129 Chip keyring „Ghost“ with chip

Extra-flat, ergonomic chip holder without keyring. Includes chip.

Piece(s)	1	500	1000	5000	
EUR	0.39	0.33	0.28	0.26	

Plastic/Polystyrene 1500 Unit, Bulk
 45 mm x 30 mm x 3 mm



04133 Chip keyring „Fix“

Practical and ultra-flat chip holder without keyring. Includes chip.

Piece(s)	1	500	1000	5000	
EUR	0.35	0.32	0.27	0.25	

Plastic/Polystyrene 2000 Unit, Bulk
 49 mm x 32 mm x 4 mm



04121 Rotating keyring „Point“ without chip

Ultra-light key fob with keyring and a rotating compartment to hold coins or a shopping cart chip.

Piece(s)	1	500	1000	5000
EUR	0.60	0.54	0.45	0.42

📦 Plastic/Polystyrene 📦 1000 Unit, Bulk
📏 59 mm x 38 mm x 7 mm



04120 Rotating keyring „Point“ with chip

Piece(s)	1	500	1000	5000
EUR	0.71	0.63	0.53	0.50

📦 Plastic/Polystyrene 📦 1000 Unit, Bulk
📏 59 mm x 38 mm x 7 mm



04137 Rotating keyring „Heart“

Close to your heart. Heart-shaped shopping cart chip with keyring.

Piece(s)	1	500	1000	5000
EUR	1.16	1.03	0.87	0.81

📦 Plastic/Polystyrene 📦 1000 Unit, Bulk
📏 46 mm x 42 mm x 10 mm



04128 Chip keyring „Elegance“

Always at hand. Useful metal shopping cart chip made of metal with carabiner hook and keyring.

Piece(s)	1	500	1000	5000
EUR	0.65	0.58	0.49	0.46

📦 Metal 📦 1000 Unit, Polybag
📏 84 mm x 23 mm x 7 mm

Wellness and Healthcare.

- *Eye masks*
- *Community masks*
- *first aid*
- *Gel cushion*
- *Hairbrushes*
- *Hygiene*
- *Manicure*
- *Oral Hygiene*
- *Pillboxes*
- *Protective equipment*
- *Wellness and massage*





05096 Plaster box „Cross“

Practical, light plaster box shaped like a cross. The low height makes it an ideal companion wherever you go. Ideal for travelling. Filled with 4 dual quality plasters by Hartmann.

Piece(s)	1	500	1000	5000	
EUR	1.78	1.59	1.34	1.25	

Plastic/Polypropylene 150 Unit, Bulk
 104 mm x 100 mm x 13 mm



05101 Bandage box „Stripe“

Can be opened single-handedly with a press of a button. The practical plastic box filled with 10 high quality plasters from Hartmann. Various colour combinations and an embossed logo on the button possible on request.

Piece(s)	1	500	1000	5000	
EUR	1.58	1.42	1.19	1.11	

Plastic/Polypropylene 450 Unit, Bulk
 83 mm x 36 mm x 16 mm



05091 First Aid Kit „Plaster Box“

Ultra flat box with 4 dual quality plasters by Hartmann. IMould finish possible.

Piece(s)	1	500	1000	5000
EUR	1.62	1.45	1.22	1.14

Plastic/Polypropylene 250 Unit, Bulk
 102 mm x 68 mm x 11 mm



05117 Emergency kit „Emergency“

All important things at hand. Rescue kit, consisting of box 05269, filled with high quality articles: plaster, emergency bandage, plaster strips, first-aid kit, compresses, fixing bandage, scissors, disposable gloves.

Piece(s)	1	100	500	1000
EUR	7.16	6.41	5.40	5.04

Plastic/Polypropylene 40 Unit, Bulk
 185 mm x 135 mm x 53 mm



05115 Travelbox „First Aid“

Square, practical plastic box with click closure that can be easily opened with one hand. Filled with 10 water-resistant and 10 high-quality Hartmann band-aids and 1 hygiene cloth.

Piece(s)	1	100	500	1000
EUR	3.44	3.08	2.59	2.42

Plastic/Polypropylene 140 Unit, Bulk
 110 mm x 103 mm x 24 mm



05479 Box „First Aid“

The box with the child lock, filled with different double plaster strips by Hartman (5 pieces each), one hygienic wipe and one refreshing wipe. Great, flat plastic box with special lock (05478) which can only be opened by lifting two opposed quick-release catches.

Piece(s)	1	100	500	1000
EUR	3.57	3.20	2.69	2.51

Plastic/Polypropylene 70 Unit, Bulk
 158 mm x 118 mm x 30 mm



05073 First Aid Kit „Box“, large

Plastic box with 2 click fasteners, full of quality articles. Plasters, first aid dressings, plaster strips, bandage packs, compresses, immovable bandage, small pair of scissors, disposable gloves.

Piece(s)	1	100	500	1000	
EUR	9.55	8.54	7.20	6.72	

Plastic/Polypropylene 50 Unit, Bulk
 180 mm x 125 mm x 45 mm



05072 First Aid Kit „Box“, small

Plastic box with 1 click fastener, full of quality articles. Plasters, first aid dressings, plaster strips, compresses, immovable bandage, small pair of scissors, disposable gloves.

Piece(s)	1	100	500	1000	
EUR	8.23	7.37	6.21	5.79	

Plastic/Polypropylene 120 Unit, Bulk
 125 mm x 85 mm x 40 mm

NEW!



01880 First Aid Kit „Pouch“, small

The practical set is always to hand. Polyester bag filled with high-quality items: sticking plasters, wound dressing, 2 plaster strips, bandage pack, 2 compresses, elastic bandage, small scissors and disposable gloves.

Piece(s)	1	100	500	1000
EUR	7.31	6.54	5.51	5.14

Textile/Polyester Polybag
 160 mm x 120 mm

01881 First Aid Kit „Pouch“, large

Piece(s)	1	100	500	1000
EUR	8.67	7.76	6.54	6.10

Textile/Polyester Polybag
 160 mm x 120 mm



08513 First Aid Kit „Bag“, small

Practical polyester bag with handle, 2 interior pockets and all-round zipper. Full of quality articles. Plasters, first aid dressings, plaster strips, compresses, immovable bandage, small pair of scissors, disposable gloves.

Piece(s)	1	100	500	1000
EUR	8.97	8.03	6.77	6.31

Textile/Polyester 600D 100 Unit, Polybag
 165 mm x 120 mm x 50 mm





04316 Key pendant „Anti-Tick“

Always at hand in case of an emergency. Tick remover to push out with eye to attach to bunch of key. Standard supply without key ring.

Piece(s)	1	500	1000	5000	EUR
EUR	0.56	0.50	0.42	0.39	

Plastic/Polystyrene 2000 Unit, Bulk
 61 mm x 22 mm x 4 mm



00630 Key fob „Tick map“

More than just convenient: The trolley chip is integrated in the housing of the key pendant which carries a groove with additional use. Due to its special form a tick can be easily removed from the skin. Keyring included.

Piece(s)	1	500	1000	5000	EUR
EUR	0.61	0.55	0.46	0.43	

Plastic/Polystyrene 2000 Unit, Bulk
 45 mm x 27 mm x 6 mm



04314 Key pendant box „Anti-Tick“

An indispensable set for the summer. Practical plastic box with 1 pair of disposable gloves, key ring and integrated tick remover to push out.

Piece(s)	1	500	1000	5000
EUR	1.25	1.12	0.94	0.88

Plastic/Polystyrene 500 Unit, Bulk
 65 mm x 30 mm x 14 mm



04315 Key pendant card „Anti-Tick“

3 in 1. Plastic card with integrated scale up to 6 cm removeable shopping cart chip and a tick remover to push out. Including eye to attach to bunch of keys.

Piece(s)	1	500	1000	5000	EUR
EUR	0.71	0.64	0.54	0.50	

Plastic/Polystyrene 500 Unit, Bulk
 82 mm x 51 mm x 4 mm



04317 Tick card

The useful and flat card will pester the miniature vampires. Easy removal of ticks by means of the two slots at the corners. The built-in magnifying glass can then be used to check if the arachnid has been completely removed.

Piece(s)	1	500	1000	5000	
EUR	0.79	0.71	0.59	0.55	

Plastic/Polystyrene 1280 Unit, Bulk
 86 mm x 54 mm x 1 mm



04049 Ampule opener

Ampule opener for break-open ampules.

Piece(s)	1	500	1000	5000
EUR	1.03	0.92	0.78	0.72

Plastic/ABS 300 Unit, Individual carton
 70 mm x 16 mm x 15 mm



03663 Storage box „Duo“

Handy box made of food safe plastic with 2 separate compartments and snap fastener. The smooth surface ensures best possible use of the advertising surface.

Piece(s)	1	500	1000	5000	
EUR	0.33	0.30	0.25	0.23	

Plastic/Polypropylene 400 Unit, Bulk
 61 mm x 40 mm x 14 mm

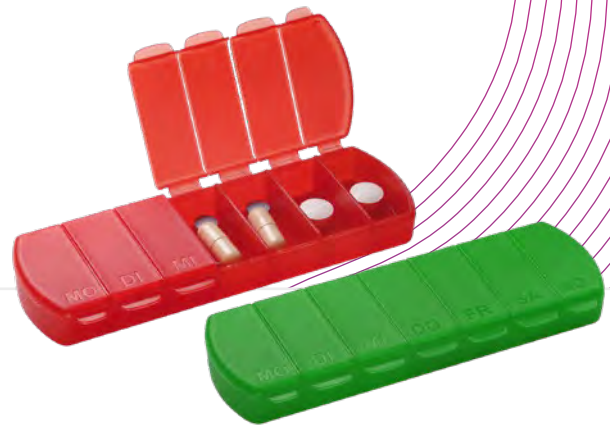

03664 Storage box „Seven Days“

A compartment for each day of the week. Light, transparent box made of food safe plastic with 7 compartments, separated by 6 webs. Ideal for travelling, as the articles can't be mixed up even if you turn the box on its head. Days of the week labels in German.

Piece(s)	1	500	1000	5000	
EUR	0.64	0.57	0.48	0.45	

Plastic/Polypropylene 200 Unit, Bulk
 110 mm x 40 mm x 14 mm



05407 Protective box „Toothbrush“

Fold-up plastic box with space for 1 toothbrush - protects against soiling. Ideal for travelling.

Piece(s)	1	500	1000	5000
EUR	0.87	0.78	0.66	0.61



 Plastic/Polypropylene

 150 Unit, Bulk

 205 mm x 26 mm x 24 mm



05226 Toothbrush tumbler „Clean“

For dental hygiene. Made of plastic with large advertising space! Capacity: 0.2 litres.

Piece(s)	1	500	1000	5000	
EUR	0.90	0.80	0.68	0.63	

Plastic/Polystyrene 130 Unit, Bulk
 91 mm x Ø 70 mm



05277 Toothbrush tumbler „Fresh“

For dental hygiene. Made of plastic with large advertising space!

Piece(s)	1	500	1000	5000	
EUR	0.82	0.74	0.62	0.58	

Plastic/Polystyrene 180 Unit, Bulk
 82 mm x Ø 64 mm



05225 Toothbrush tumbler „Pure“

For dental hygiene. Made of plastic with large advertising space! Capacity: 0.2 litres.

Piece(s)	1	500	1000	5000	
EUR	0.65	0.58	0.49	0.46	

Plastic/Polystyrene 250 Unit, Bulk
 91 mm x Ø 64 mm



05288 Children tooth mug „Care“

Ideal for storing children's toothbrushes and for rinsing after brushing the teeth. Great plastic mug in conical shape and with raised rim. Available in different colours.

Piece(s)	1	500	1000	5000	
EUR	0.34	0.30	0.25	0.24	



Plastic/Polypropylene 100 Unit, Bulk
 127 mm x Ø 67 mm



06180 Eye mask „Oasis“

Cooling mask with elastic strap. Put in refrigerator before using it. Partial and comfortable cooling for tired eyes.

Piece(s)	1	500	1000	5000
EUR	1.43	1.28	1.08	1.01



 Plastic/PVC  250 Unit, Plastic box
 200 mm x 50 mm



08246 Eye mask „Relax“

Black eye mask made of nylon with double rubber band for a good fit and great wearing comfort. In screen printing only in silver or gold printable.

Piece(s)	1	500	1000	5000
EUR	1.06	0.95	0.80	0.75

 Plastic/Polyamide  500 Unit, Polybag
 185 mm x 80 mm x 4 mm



06183 Eye mask „Wellness“

Place in refrigerator before use. With cooling gel and hook-and-loop fastener.

Piece(s)	1	100	500	1000
EUR	2.82	2.52	2.12	1.98



 Plastic/PVC  100 Unit, Plastic box
 170 mm x 85 mm x 5 mm

Image source: stock.adobe.com / Andrey Milkin



05224 Massage device „Relaxation“

Head massage device with anodised aluminium handle and flexible massage rods made of stainless steel with rounded ends for a pleasant sensation. Goosebumps and relaxation due to stimulation of the scalp. Just try it - it works. Handle 85 mm and rods 170 mm.

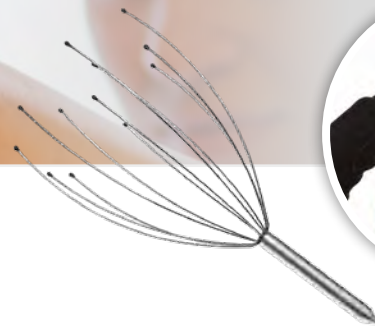
Piece(s)	1	100	500	1000
EUR	2.13	1.90	1.59	1.49

 Metal/Steel
 250 mm x Ø 90 mm



 100 Unit, Individual carton



06230 Wellness-Ball „Hedgehog“

The blood circulation is stimulated by moving the knobby ball across the body.

Piece(s)	1	500	1000	5000
EUR	1.22	1.10	0.92	0.86

 Plastic/PVC
 Ø 70 mm

 100 Unit, Polybag



01644 Soap Dispenser „Bamboo“, 0.2 l

Beautiful bamboo soap dispenser in a natural and minimalist design, which will make the perfect addition to any bathroom. Once the soap or lotion has been used up, the dispenser can be easily refilled. The pump action enables the individual dosing of the quantity to be dispensed. Capacity: 0.2 litres.

Piece(s)	1	100	500	1000
EUR	8.03	7.19	6.06	5.65

Wood/Bamboo + ABS 50 Unit, Individual carton
 65 mm x 65 mm x 180 mm

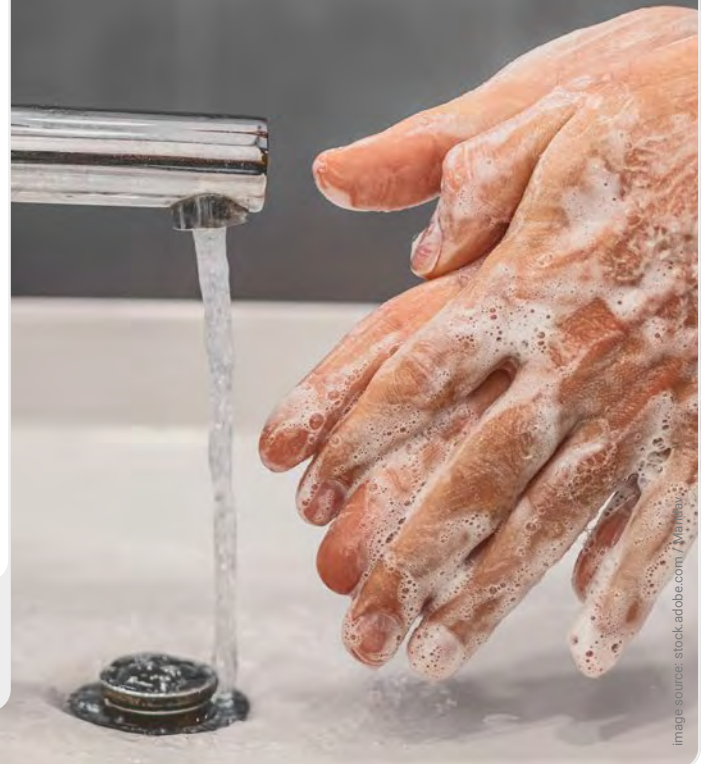

Image source: stock.adobe.com / Marney

01436 Soap Dispenser „Pure“ 250 ml

Small, practical soap dispenser for travelling, camping or simply for home use. Refillable, reusable, environmentally-friendly, portable and featuring a metal spring. Simple and comfortable to operate. With a locking function in the pump mechanism. Filling capacity: 250 ml.

Piece(s)	1	100	500	1000
EUR	1.82	1.63	1.37	1.28

Plastic/PP + PET 200 Unit, Individual carton + Polybag
 50 mm x 50 mm x 166 mm x Ø 50 mm



01437 Soap Dispenser „Pure“ 500 ml

Piece(s)	1	100	500	1000
EUR	2.14	1.91	1.61	1.50

Plastic/PP + PET 200 Unit, Individual carton + Polybag
 64 mm x 64 mm x 189 mm x Ø 64 mm

#stayclean - Soap dispensers and spray bottles.

Quality Made in Germany.

- ✓ Made of very high quality, taste- and odorless tritan.
- ✓ Breakproof material.
- ✓ BPA free and without critical plasticizers.
- ✓ The wide opening makes it easy to fill and clean.
- ✓ Suitable for disinfectants.
- ✓ Leakproof.



Volume.

0,4 / 0,7 / 1,0 LITER



Choice of lids.



Lid colour options:
Matte or metal look



Bottle colours.

Solid colour



Transparent



Finishing tip.

Dishwasher-safe all-round printing using the PremioTouch process in photorealistic quality with haptic effect.



NEW!

01671 Soap dispenser „Basic“ 0.4 l, clear/transparent

A soap dispenser with a high-quality tritan vessel and plastic pump. Provides the perfect amount, as the desired quantity of soap or lotion can be pumped out by gently pressing the dosage button. Refillable and reusable, thanks to the large opening. Due to the locking function of the dispenser, accidental activation of the pump can be prevented. Capacity: 0.4 litres.

Piece(s)	1	100	500	1000
EUR	3.88	3.59	3.22	3.08

Plastic/Tritan + PP
215 mm x Ø 65 mm

40 Unit, Bulk



01673 Soap dispenser „Basic“ 1.0 l, clear/transparent

Piece(s)	1	100	500	1000
EUR	5.79	5.31	4.69	4.45

01672 Soap dispenser „Basic“ 0.7 l, clear/transparent

Piece(s)	1	100	500	1000
EUR	5.23	4.81	4.25	4.05

01673
260 mm x Ø 1 mm
24 Unit, Bulk

01672
235 mm x Ø 80 mm
24 Unit, Bulk

NEW!

01674 Soap dispenser „Basic“ 0.4 l, colour

A soap dispenser with a high-quality tritan vessel and plastic pump. Provides the perfect amount, as the desired quantity of soap or lotion can be pumped out by gently pressing the dosage button. Refillable and reusable, thanks to the large opening. Due to the locking function of the dispenser, accidental activation of the pump can be prevented. Capacity: 0.4 litres.

Piece(s)	1	100	500	1000
EUR	4.10	3.80	3.40	3.25

Plastic/Tritan + PP
215 mm x Ø 65 mm

40 Unit, Bulk



01676 Soap dispenser „Basic“ 1.0 l, colour

Piece(s)	1	100	500	1000
EUR	6.16	5.65	4.98	4.72

01675 Soap dispenser „Basic“ 0.7 l, colour

Piece(s)	1	100	500	1000
EUR	5.49	5.05	4.46	4.23

01676
260 mm x Ø 88 mm
24 Unit, Bulk

01675
235 mm x Ø 80 mm
24 Unit, Bulk



06164 Gel heating pad „House“

Piece(s)	1	500	1000	5000
EUR	1.47	1.32	1.10	1.03

Plastic/PVC
 100 Unit, Bulk
 135 mm x 115 mm x 10 mm



06162 Gel heating pad „Heart“

Piece(s)	1	500	1000	5000
EUR	1.02	0.91	0.77	0.72

Plastic/PVC
 100 Unit, Bulk
 110 mm x 115 mm x 10 mm



06170 Gel heating pad „Oval“, large

Piece(s)	1	500	1000	5000
EUR	1.12	1.00	0.84	0.79

Plastic/PVC
 100 Unit, Bulk
 110 mm x 80 mm x 10 mm



06177 Gel heating pad „Oval“, small

Piece(s)	1	500	1000	5000
EUR	0.79	0.70	0.59	0.54

Plastic/PVC
 100 Unit, Bulk
 90 mm x 63 mm



06171 Gel heating pad „Square“

Piece(s)	1	500	1000	5000
EUR	1.33	1.19	1.00	0.93

Plastic/PVC
 100 Unit, Bulk
 98 mm x 98 mm x 15 mm

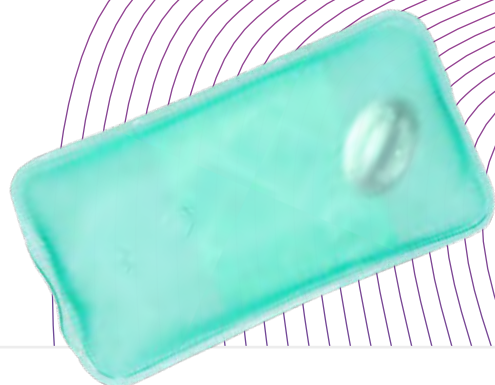

06172 Gel heating pad „Rectangle“

Piece(s)	1	500	1000	5000
EUR	1.07	0.96	0.81	0.75

Plastic/PVC
 100 Unit, Bulk
 110 mm x 60 mm x 10 mm



06187 Gel heating pad „Round“

Piece(s)	1	500	1000	5000
EUR	0.95	0.85	0.71	0.67

Plastic/PVC

100 Unit, Bulk

10 mm x Ø 95 mm



06196 Gel heating pad „Snowman“

Piece(s)	1	500	1000	5000
EUR	0.76	0.67	0.57	0.53

Plastic/PVC

100 Unit, Bulk

130 mm x 80 mm x 10 mm



06168 Gel heating pad „Star“

Piece(s)	1	500	1000	5000
EUR	1.26	1.13	0.96	0.89

Plastic/PVC

100 Unit, Bulk

120 mm x 120 mm x 5 mm



06173 Gel heating pad „Hot-water bottle“

Piece(s)	1	500	1000	5000
EUR	0.90	0.82	0.67	0.63

Plastic/PVC

100 Unit, Bulk

115 mm x 65 mm x 10 mm



09198 Cooling/heating pad „Bead“, oval

Piece(s)	1	500	1000	5000
EUR	1.25	1.12	0.94	0.88

Plastic/PVC

250 Unit, Polybag

110 mm x 80 mm x 20 mm



09197 Cooling/heating pad „Bead“, round

Piece(s)	1	500	1000	5000
EUR	1.20	1.07	0.90	0.84

Plastic/PVC



250 Unit, Polybag

20 mm x Ø 100 mm



06179 Cooling/heating pad „Fresh“, small



Piece(s)	1	500	1000	5000
EUR	1.27	1.18	1.08	1.01

 Plastic/PVC
  80 Unit, Individual carton
 150 mm x 105 mm x 10 mm



06184 Cool/hot pad "Relieve"



Piece(s)	1	500	1000	5000
EUR	1.42	1.27	1.07	1.00

 Plastic/PVC
  80 Unit, PVC box
 135 mm x 90 mm x 15 mm



06188 Cooling/heating pad „Round“



Piece(s)	1	500	1000	5000
EUR	0.90	0.81	0.68	0.64

 Plastic/PVC
  100 Unit, Bulk
 10 mm x Ø 95 mm



06193 Cool/heat pad „Soft“, white



Piece(s)	1	100	500	1000
EUR	2.07	1.85	1.56	1.46

 Plastic/PVC
  80 Unit, Individual carton
 180 mm x 95 mm x 17 mm



06277 Cooling pad „Active“, small

Piece(s)	1	500	1000	5000
EUR	1.33	1.19	1.01	0.94

 Plastic/PVC
  100 Unit, Individual carton
 145 mm x 110 mm x 10 mm

Safety for life.

Protective Items.

Why we do what we do.

In the current Covid-19 crisis, the demand for high-quality respiratory masks, mouth and nose masks, as well as other protective items is enormous. We have therefore decided to expand our product range with these articles.

We offer the best quality at fair prices.

Thanks to our long-standing cooperation with our excellent suppliers, we are able to offer protective items of the highest quality and at fair prices. These are subject to a stringent and permanent quality control process and are produced by us in line with European standards. Our production process, packaging, and storage all adhere to the highest standards in terms of environmental-friendliness and hygiene, and are the basis of our work.

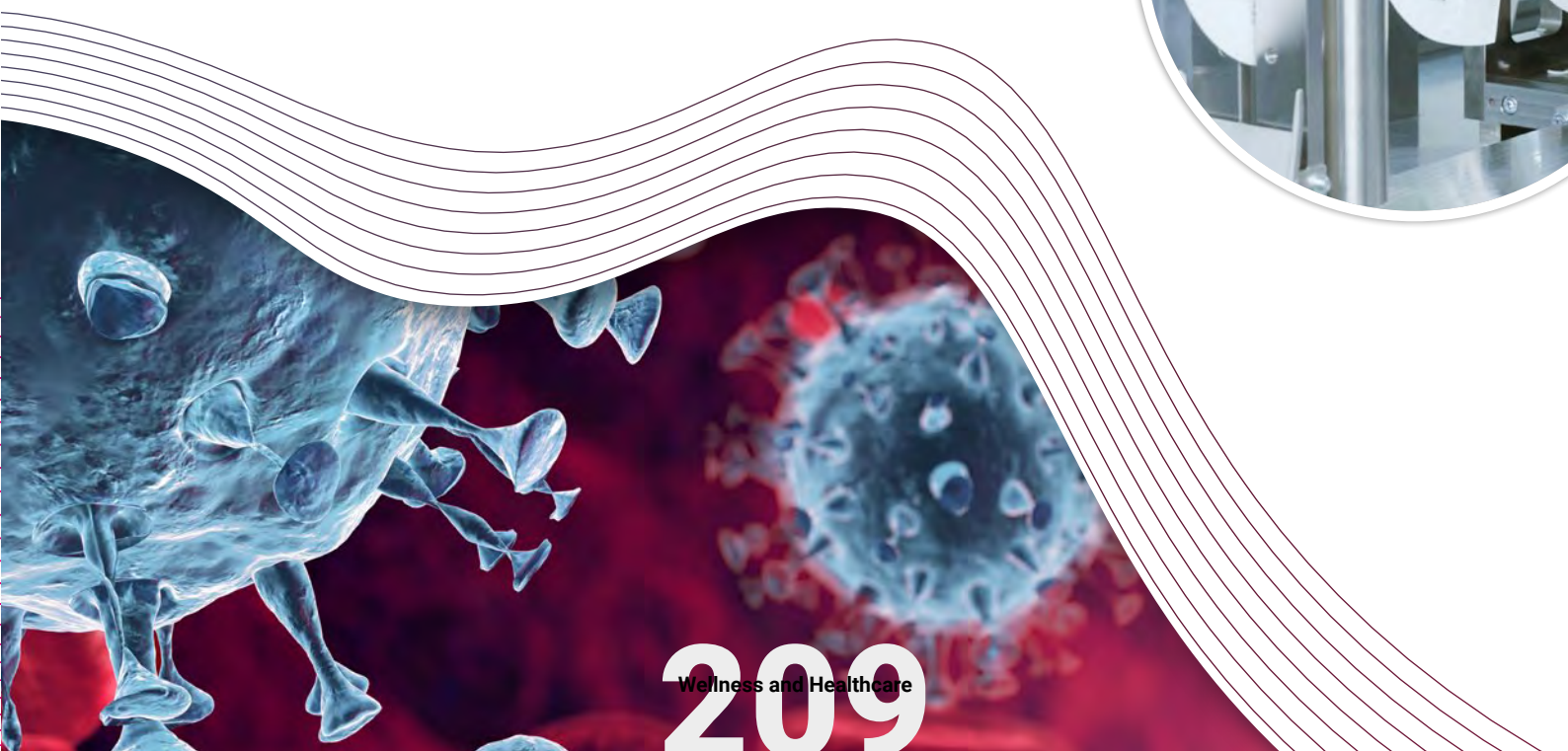

Respiratory Mask.

FFP2 and FFP3.

CERTIFIED

In accordance with Regulation (EU) 2016/425 and the European EN 149:2001 + A1:2009 standard.



*Quality
Made in
Germany.*

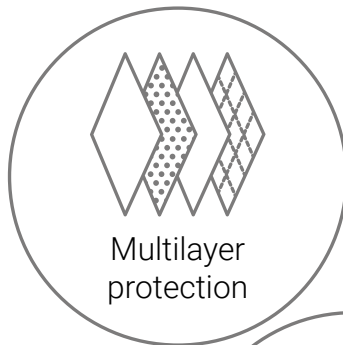

Multilayer protection

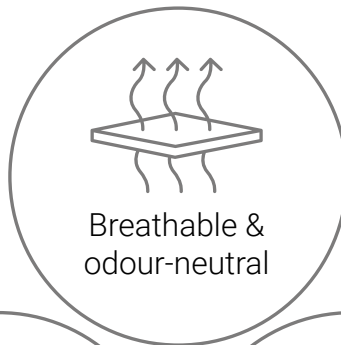

Breathable & odour-neutral

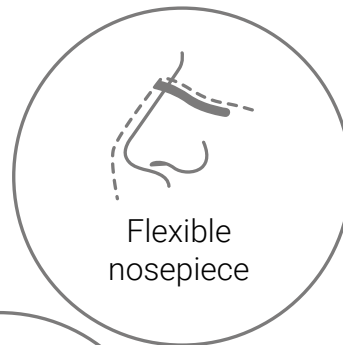

Flexible nosepiece



Aerosol protection

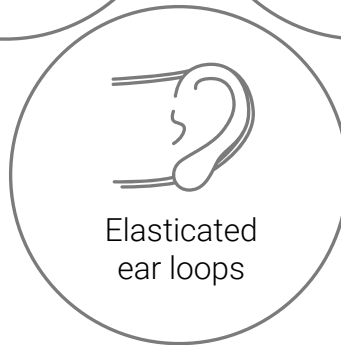

Elasticated ear loops

Our quality promise.

- Production and Material – 100% Made in Germany.
- High-quality processing in accordance with European standards.
- Highest standards with regard to environmentally-friendly and hygienic production processes, packaging and storage.
- Uncompromising and consistent quality checking for the most exacting requirements and security.

Your benefits.

- The use of high-quality German filter fabrics means that there is no need for redundant additional filter layers. This makes breathing and the long-term wearing of the mask much more pleasant than with the majority of other models.
- Safe and effective protection for the wearer against particles, liquids and solid aerosols.
- Free from glass fibres, latex and odours.
- Extra skin-friendly non-woven fabric with very low breathing resistance, a higher level of comfort and an exceptional fit.

Your respiratory masks with custom colour printing.

CERTIFIED

In accordance with Regulation (EU) 2016/425 and the European EN 149:2001 + A1:2009 standard.

Minimum quantity:
from 50 sets (500 masks).

Up to 4 colours per motif.

Max. Print size:
Ø 40 mm.



NEW!

01747

Respiratory Mask „Colour” FFP2 NR, set of 10

Made in Germany. The colourful respiratory mask made from extremely high-quality fleece, offers reliable protection from liquid and solid aerosols. The fleece consists of 5 layers which are robustly interconnected. Furthermore, it offers very low breathing resistance and is particularly skin-friendly. The mask's ties are elasticated and ensure a high level of wearing comfort. The flexible and adjustable nose clip is integrated into the mask, allowing it to fit the shape of the nose perfectly. Not reusable. Not washable. Certified according to Regulation (EU) 2016/425 and the European Standard EN 149:2001 + A1:2009 (also includes printed masks).

Quality Made in Germany.

Textile/Meltblown
85 mm x 180 mm x 4 mm

25 Unit, 10 pcs. In a polybag



Price on request

Respiratory Mask.

FFP2 and FFP3.



01481 Respiratory Mask „A” FFP2 NR (Set of 10)

Quality Made in Germany.

Price on request

Textile/Polypropylene
85 mm x 180 mm

30 Unit, 10 pcs. In a polybag

NEW!



01746 Respiratory Mask „CareAir” FFP2 NR (Set of 10)

Quality Made in Germany.

Price on request

Textile/Polypropylene
85 mm x 180 mm

25 Unit, 10 pcs. In a polybag

NEW!



01764 Respiratory Mask „AirCare” FFP2 NR (Set of 10)

Quality Made in Germany.

Price on request

Textile/Meltblown
85 mm x 180 mm

30 Unit, 10 pcs. In a polybag

NEW!

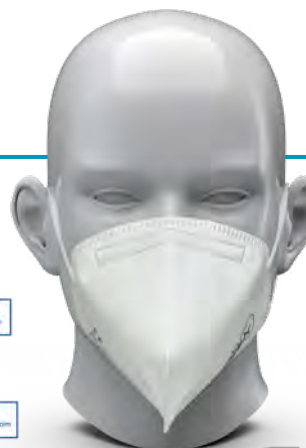

01769 Respiratory Mask „CareOne” FFP2 NR (Set of 10)

Quality Made in Germany.

Price on request

Textile/Meltblown
85 mm x 180 mm

30 Unit, 10 pcs. In a polybag

NEW!

01740 Mask holder „Comfort“, large

Avoid painful ears after wearing your mask for a long time. With this holder, weight is shifted away from sensitive ears towards the back of the head. It is suitable for use with all commonly used mouth and nose protection masks. Thanks to the number of hooks, your mask can be perfectly adapted to fit the size of your head. The mask holder can be cleaned with a cloth and detergent. It can also be cleaned with disinfectant. This ensures that it can be reused any number of times.

Piece(s)	1	500	1000	5000	
EUR	0.46	0.41	0.35	0.33	

Plastic/Polypropylene
 184 mm x 25 mm

2000 Unit, Bulk

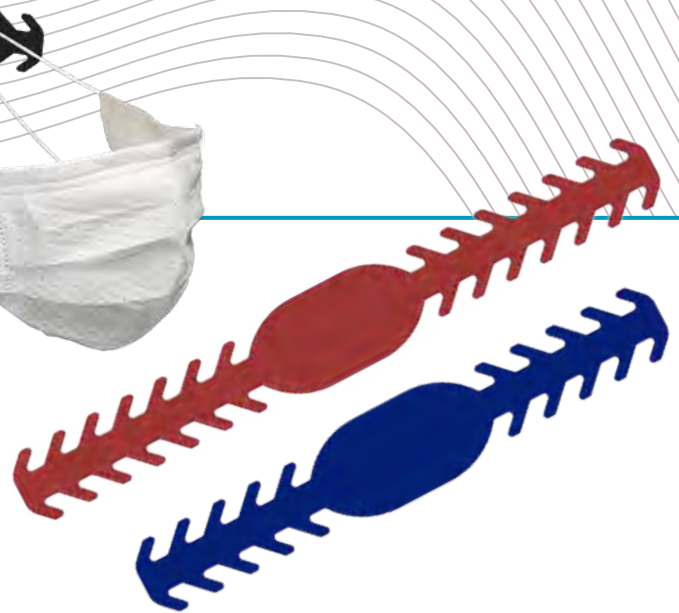

01492 Mask holder „Comfort“, medium

Piece(s)	1	500	1000	5000	
EUR	0.41	0.37	0.31	0.29	

Plastic/Polypropylene
 145 mm x 25 mm

2000 Unit, Bulk

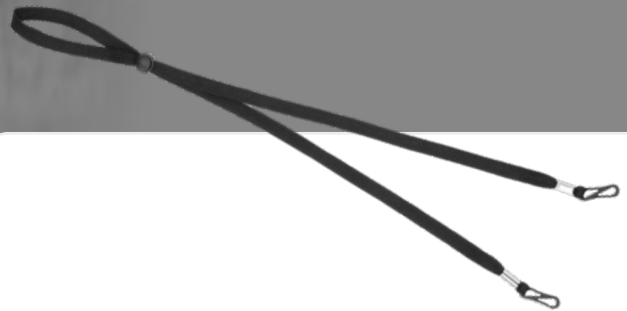

01654 Mask fixture „Adjust“

A practical mask fixture made of polyester making it extra soft to wear. The strap ensures that, even when you remove the mask, it is still around your neck ready to use, and thus does not get lost. The adjustable stopper means that the length of the strap can be adjusted individually.

Piece(s)	1	500	1000	5000
EUR	0.82	0.73	0.62	0.57

Textile/Polyester
 900 mm x 10 mm

2500 Unit, Polybag



01493 Face visor „Protection“

Generous facial shield offering a high level of comfort. The visor folds up, with 4 different levels. The size of the strap can be adjusted thanks to a snap fastener. The clear visor can be removed from the headband and replaced, which enables simple cleaning. Protects the eyes, mouth, and nose from aerosols, liquid splashes, and dust. Visor 5-Pack - Refill Pack 01494

Piece(s)	1	100	500	1000
EUR	7.88	7.05	5.94	5.54

Plastic/PET-G + PP

20 Unit

260 mm x 235 mm x 220 mm



01430 Safety goggles „Safety“

These „Safety“ protection glasses will win you over with their functionality and design. The scratch-resistant lenses are made from high-quality tritan, ensuring that they can deliver high comfort for a long time. They are break-resistant and offer reliable all-round protection for the eyes thanks to their raised lenses. Also suitable for people who wear glasses. Individually boxed. Compliant with (EU) regulation 2016/425 on personal protective equipment, Class II (protection against moderate risks) EN 166:2001.

Piece(s)	1	100	500	1000
EUR	4.10	3.67	3.09	2.89



Plastic/Tritan

50 Unit, Individual carton

166 mm x 56 mm x 68 mm

Tests for self-testing.

By private individuals or can also be used by companies!



01889 COVID-19 Antigen Rapid Test

Self-test.

Manufacturer: Beijing Hotgen Biotech Co., LTD

CE0123

Price on request

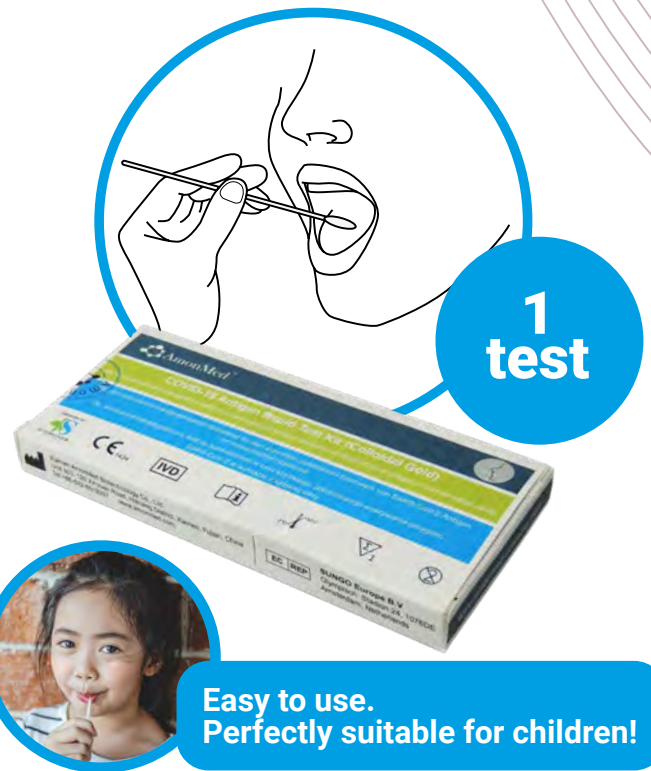

01886 COVID-19 Antigen Rapid Test

Self-test.

Manufacturer: Xiamen AmonMed Biotechnology Co., Ltd.

EC Certificate No. 1434-IVDD-467/2021, CE1434

Price on request



Simple sample collection.



Easily readable results.



No additional equipment necessary.



Rapid results.

Gargle test.

Test tubes and collection cups.

01798 Gargle test for use by pupils.
Set consisting of 2 tubes and 1 funnel.

01799 Collection cups (pool) for the school
and for sending to the testing laboratory.

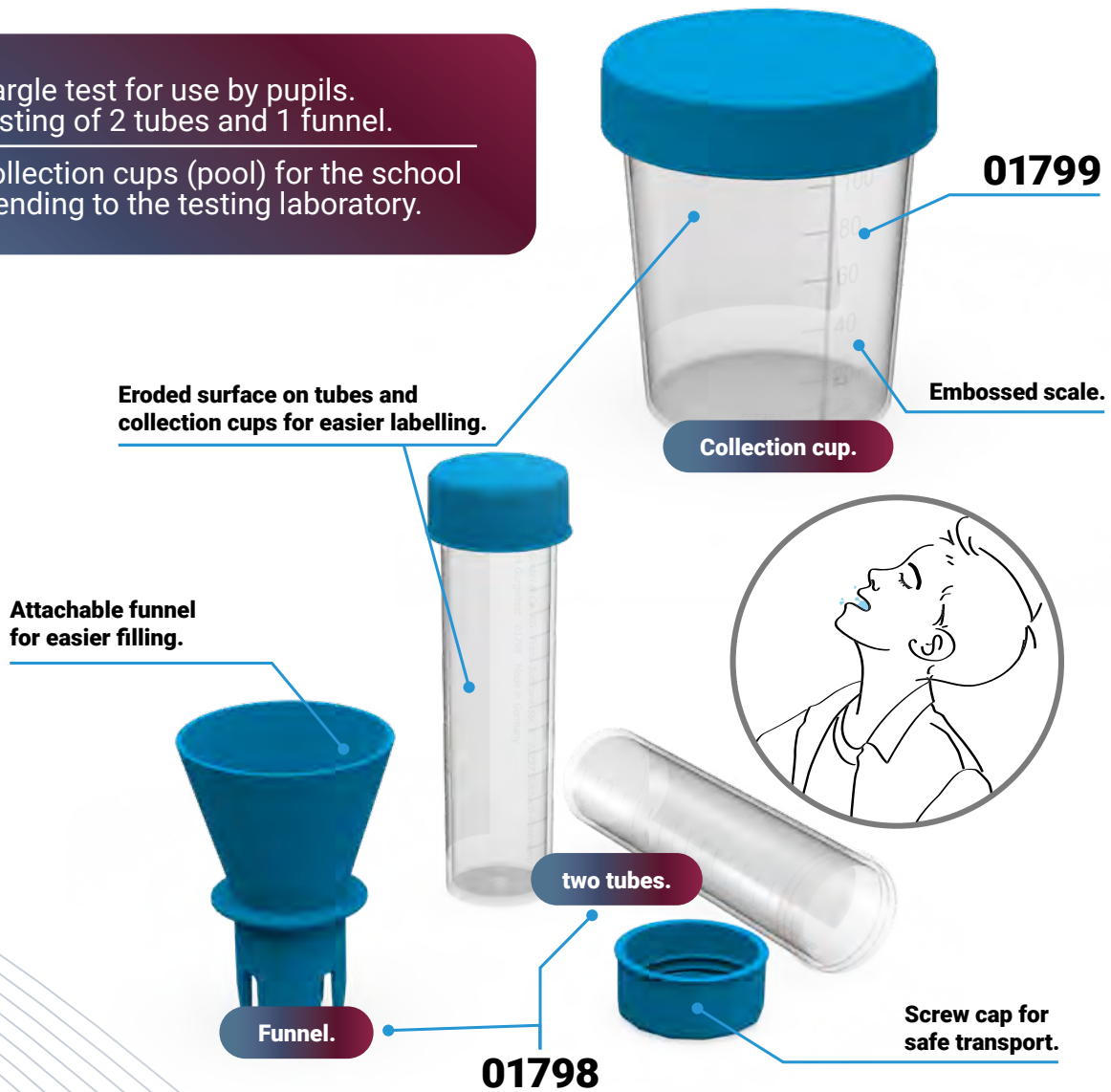

NEW!

Quality Made in Germany.

01798 Tube gargle test, 15ml

Set with 2 tubes and a funnel. The tubes have an embossed scale (1ml graduations) and a capacity of 15ml. Each has a screw cap. The reverse side is eroded for better labelling. Together with the collection cup (item no. 01799), you have all the items required for the so-called gargle test from the Wicovir study. This test procedure involves the testing of participating school classes twice weekly. This means: gargle tap water in the morning after getting up and fill the two tubes with the liquid. In the school, the contents of one of the two tubes is poured into a „pool“ (collection cup). Afterwards, the combined fluids from the group are tested. If there are any indications of a Coronavirus infection, children and adolescents must present their second tube for individual tests so that the infected pupil(s) can be filtered out.

Price on request

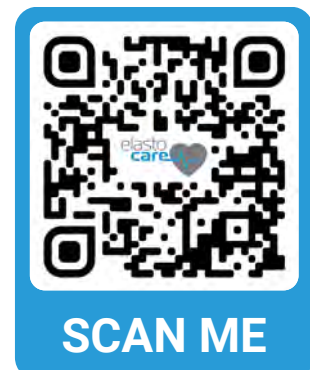

elasto.care/gurgeltest

01799 Collection cup
gargle test

Price on request

Hand disinfectant and hand cleansing gel.



Quality
Made in
Germany.

Whether at home, at work or while shopping – our gels can be used everywhere!



dermatest-garantie.de



01681 Hand cleansing gel „Classic“, 50ml

Piece(s)	480	960	4800	9600
EUR	1.52	1.46	1.29	1.16

01682 Hand cleansing gel „Classic“, 100ml

Piece(s)	480	960	4800	9600
EUR	2.19	1.85	1.73	1.67

- ✓ Cleanses and refreshes the hands.
- ✓ Registered with CPNP (Cosmetic Products Notification Portal).
- ✓ Bottle & Filling - Made in Germany.
- ✓ Bottle made of recycled plastic RPET.
- ✓ Dermatologically tested - excellent.
- ✓ Meets the requirements of the Cosmetics Regulation EU1223/2009.



dermatest-garantie.de



01683 Hand disinfectant gel „Mano“, 50ml

Piece(s)	480	960	4800	9600
EUR	2.10	1.92	1.67	1.52

01684 Hand disinfectant gel „Mano“, 100ml

Piece(s)	480	960	4800	9600
EUR	2.69	2.51	2.43	2.22

- ✓ Hand disinfection works undiluted in 30 sec.
- ✓ Registered at the BAuA. Bactericidal, levurocidal, tuberculocidal.
- ✓ Bottle, gel & filling - Made in Germany.
- ✓ Bottle made of recycled plastic RPET.
- ✓ Dermatologically tested - excellent. Fragrance free.
- ✓ Meets the requirements of the Biocide Regulation 528/2012.

SALE!



01468 Hand gel „Bumper“

Clear hand gel for cleaning all sorts of hands. Thanks to the individually adjustable silicon straps, the bottle can be securely attached to any trousers, bag or backpack. Refillable thanks to the screw cap. Capacity: 30 ml.

Piece(s)	1	500	1000	5000
EUR	0.64	0.56	0.50	0.47

 Plastic/PP + PET

 400 Unit, Bulk

 22 mm x 34 mm x 80 mm

image source: stock.adobe.com / miasaimages

SALE!





01467 Hand gel „Clean“ with carabiner

Cleans and refreshes hands. Clear hand gel for cleaning all sorts of hands. Thanks to the carabiner, the bottle can be securely attached to any trousers, bag or backpack. Refillable thanks to the screw cap. Capacity: 30 ml.

Piece(s)	1	500	1000	5000
EUR	0.64	0.56	0.50	0.47

 Plastic/PVC

 200 Unit, Bulk

 22 mm x 35 mm x 100 mm

Sports, Leisure and Events.

- *Fitness*
- *Soccer and accessories*
- *Sleds*
- *X-Mas*
- *Fan articles*





image source: [istockphoto.com/istockphoto](https://www.istockphoto.com/istockphoto)

NEW!

01703 Exercise band „Resistance“, low resistance

A high-quality exercise band for your next workout! Train the most diverse muscle groups with just one band, for an enhanced feeling of well-being. The band has a generous width and a soft surface, which prevents unpleasant cutting into the skin. The black non-slip strips on the inside are sewn securely into place and ensure that the band remains exactly where it's meant to be. Resistance: low.

Piece(s)	1	100	500	1000
EUR	3.50	3.24	2.98	2.78

Plastic/PES + Latex
 340 mm x 80 mm

120 Unit, Polybag

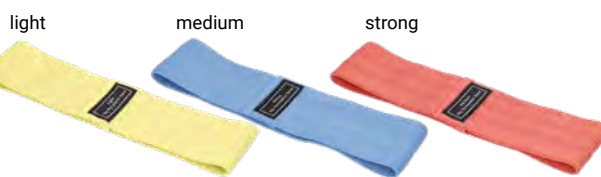

light

medium

strong

01705 Exercise band „Resistance“, high resistance

Piece(s)	1	100	500	1000
EUR	4.13	3.82	3.52	3.28

01704 Exercise band „Resistance“, medium resistance

Piece(s)	1	100	500	1000
EUR	3.83	3.55	3.26	3.04

01705
 340 mm x 80 mm
 120 Unit, Polybag

01704
 340 mm x 80 mm
 120 Unit, Polybag

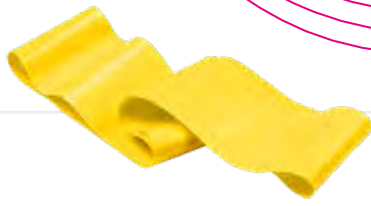

light



medium

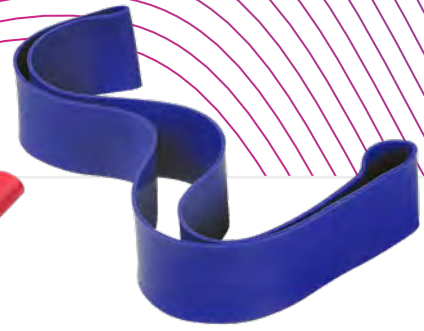

strong

09383 Rubber band „Loop“ light

Targeted and joint-protecting muscle workout for everyone. Circular rubber band, suitable for many different exercises and for improving different muscles and muscle groups. Resistance: slight.

Piece(s)	1	500	1000	5000
EUR	1.61	1.44	1.22	1.13

09385 Rubber band „Loop“ strong

Piece(s)	1	100	500	1000
EUR	2.35	2.10	1.77	1.65

09384 Rubber band „Loop“ medium

Piece(s)	1	500	1000	5000
EUR	2.07	1.86	1.56	1.46

Plastic/Latex
600 mm x 30 mm

1000 Unit, Polybag
Sport items

09385
600 mm x 30 mm
500 Unit, Polybag

09384
600 mm x 30 mm
625 Unit, Polybag



light



medium



strong

09391 Fitness box „Light“

Elegant box (05134) filled with the rubber band „Loop“ light (09383). Incl. instructions for different muscle exercises. There is additional space for one's own odds and ends.

Piece(s)	1	100	500	1000
EUR	2.38	2.13	1.80	1.68

09402 Fitness box „Strong“

Piece(s)	1	100	500	1000
EUR	3.47	3.11	2.62	2.44

09401 Fitness box „Medium“

Piece(s)	1	100	500	1000
EUR	2.83	2.53	2.13	1.99

Plastic/Polypropylene
101 mm x 78 mm x 30 mm

120 Unit, Bulk
Sport items

09402
101 mm x 78 mm x 30 mm
120 Unit, Bulk

09401
101 mm x 78 mm x 30 mm
120 Unit, Bulk



09389 Smallest Fitness studio

Keep fit. This small set enables effective training at any time, any place. The ring shaped rubber band (09383) is suitable for many various exercises and for enhancing various muscle groups. Resistance: light. Packed in a flat plastic box with a clicking lock (04084), that can be individually refined or personalised and these are also available in many different colours.

Piece(s)	1	100	500	1000
EUR	2.38	2.13	1.79	1.67

- Plastic/Polypropylene
- 250 Unit, Bulk
- 101 mm x 67 mm x 11 mm
- Sport items



01628 Gymnastics Band „Workout“, Set of 3

Practical set of 3 different loop bands in the colours black, red and yellow. The black band has the highest resistance, the yellow the lowest. As such, the bands make the perfect training tool for all those who wish to improve their strength and muscle flexibility - whether young or old, male or female, beginner or pro. Includes a practical bag with drawstring for the simple transportation of the training bands.

Piece(s)	1	100	500	1000
EUR	4.42	3.96	3.34	3.11

- Plastic/Latex
- 100 Unit, Plastic box + Polybag
- 190 mm x 80 mm

NEW!



01755 Gymnastic band „Fitness“, light

A high-quality exercise band for your next workout! Train the most diverse muscle groups with just one band, for an enhanced feeling of well-being. The band has a generous width of 4 cm and a soft surface, which prevents unpleasant cutting into the skin. The ends of the band are sewn up, preventing the band from fraying. Incl. black net bag with drawstring Length: 2.5 m. Resistance: low.

Piece(s)	1	100	500	1000
EUR	5.87	5.26	4.43	4.13

- Textile/PES + Latex
- 40 Unit, Nylon etui
- 2500 mm x 39 mm
- Sport items



01757 Gymnastic band „Fitness“, strong

Piece(s)	1	100	500	1000
EUR	6.64	5.94	5.01	4.67

01756 Gymnastic band „Fitness“, medium

Piece(s)	1	100	500	1000
EUR	6.32	5.65	4.77	4.44

- 01757**
- 2500 mm x 39 mm
- 40 Unit, Nylon etui

- 01756**
- 2500 mm x 39 mm
- 40 Unit, Nylon etui



light



medium

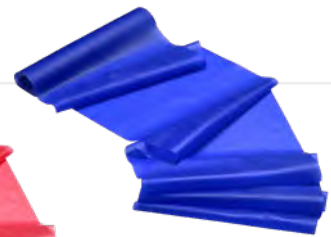

strong

09380 Exercise band „Bodywork“ light

Small thing, large effect. Elastic rubber band, ideal for exercising individual muscles or muscle groups as well as for strengthening the back. Different joint-protective exercises with this band ensure a better physical feeling. Resistance: slight.

Piece(s)	1	100	500	1000
EUR	6.39	5.72	4.82	4.50

Plastic/Latex
 2000 mm x 150 mm

250 Unit, Polybag
 Sport items

09382 Exercise band „Bodywork“ strong

Piece(s)	1	100	500	1000
EUR	8.89	7.96	6.71	6.26

09381 Exercise band „Bodywork“ medium

Piece(s)	1	100	500	1000
EUR	6.79	6.08	5.12	4.78

09382
 2000 mm x 150 mm
 150 Unit, Polybag

09381
 2000 mm x 150 mm
 200 Unit, Polybag

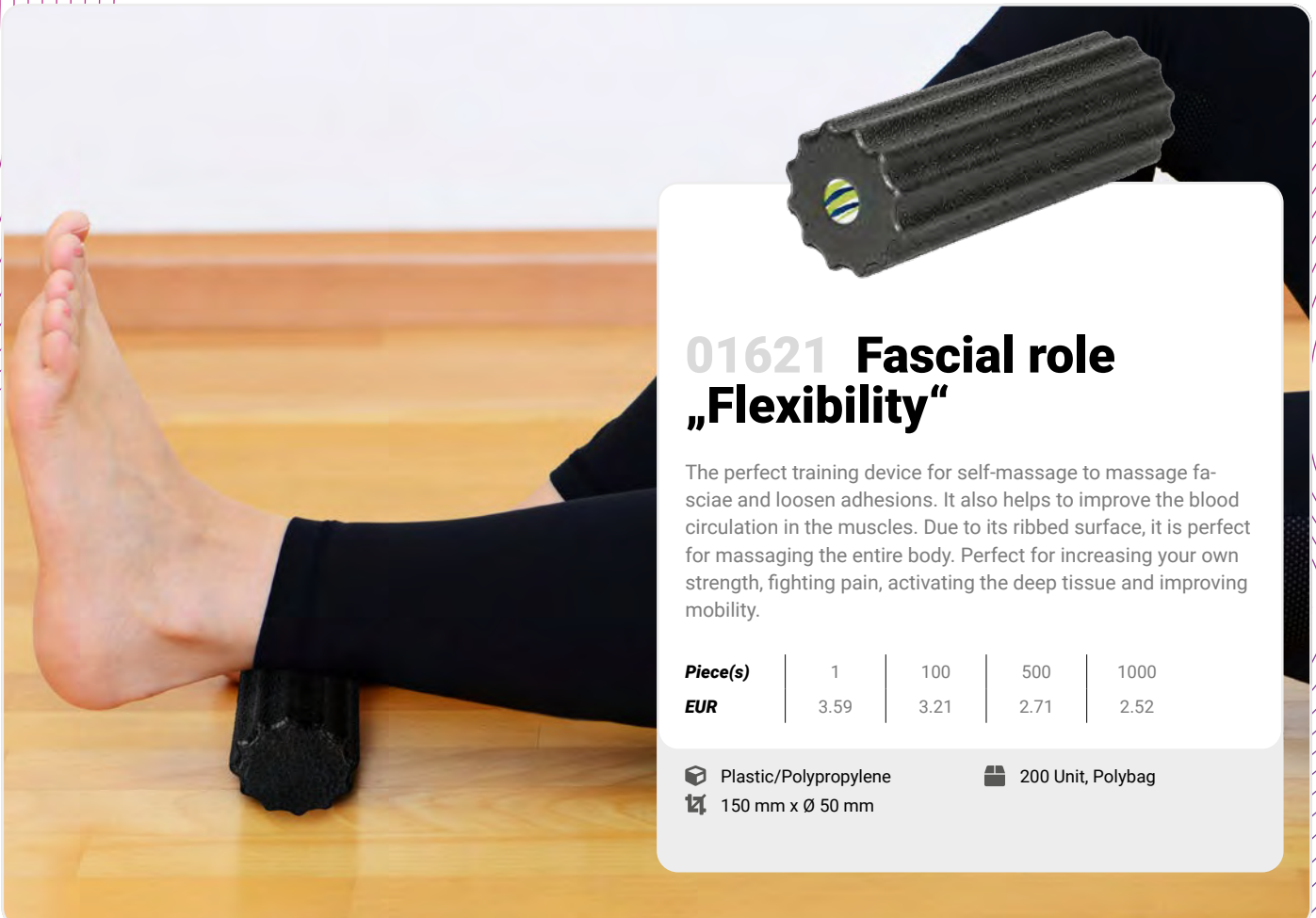

01621 Fascial role „Flexibility“

The perfect training device for self-massage to massage fasciae and loosen adhesions. It also helps to improve the blood circulation in the muscles. Due to its ribbed surface, it is perfect for massaging the entire body. Perfect for increasing your own strength, fighting pain, activating the deep tissue and improving mobility.

Piece(s)	1	100	500	1000
EUR	3.59	3.21	2.71	2.52

Plastic/Polypropylene
 150 mm x Ø 50 mm

200 Unit, Polybag



Usable on both sides.

01622 Slidepads „Flow“, set of 2

Slidepads for optimal whole-body training! Training with slidepads requires you to constantly stabilise the centre of your body and so is particularly effective. You can use both sides: the smooth plastic side for carpets the foam side for hard surfaces such as wood or tiles.

Piece(s)	1	100	500	1000
EUR	4.93	4.42	4.11	3.84

Plastic/ABS + EVA
 Ø 178 mm

50 Unit, Polybag

01627 Fitness mat „Active“

Water-repellent, washable and non-slip. This fitness mat is not just suitable for yoga and Pilates it can readily be used for fitness and gymnastics exercises too. Size: 170 x 60 cm. Thickness: 0.4 cm. A black bag is supplied along with the mat, so you can easily carry it around. With adjustable strap and draw cord for securely closing the bag.

Piece(s)	1	50	250	500
EUR	11.80	10.56	8.90	8.30

Plastic/PP + PS
 700 mm x 150 mm

20 Unit, Plastic box + Polybag



image source: stock.adobe.com / Jacob Ammentorp Lund



01452 Skipping rope „Wood“

Made of tear-proof cotton with an individually adjustable rope length. Advertising possible on wooden handles. Coloured handles on request.

Piece(s)	1	100	500	1000
EUR	4.08	3.65	3.08	2.87

Wood/Beech wood
 2500 mm x Ø 27 mm

50 Unit, Polybag
 Toys, 5+



01072 Sports bracelet „Viva“

Sporty, on the go. Elasticated sports bracelet made of 92 % polyester and 5 % elastane. The bracelet is a tube with a 7 cm long zip made of aluminium. Perfectly suited for jogging, e.g. so that you can carry your house key with you safely.

Piece(s)	1	500	1000	5000
EUR	1.89	1.69	1.42	1.33

Textile/Polyester
 10 mm x Ø 60 mm

505 Unit, Bulk
 Sport items

SALE!

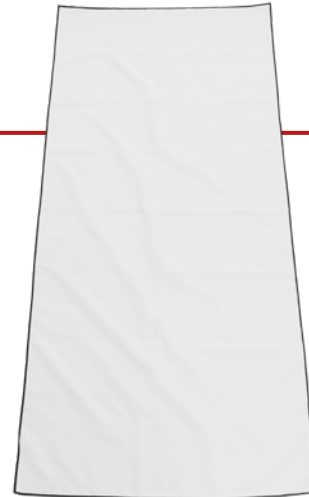
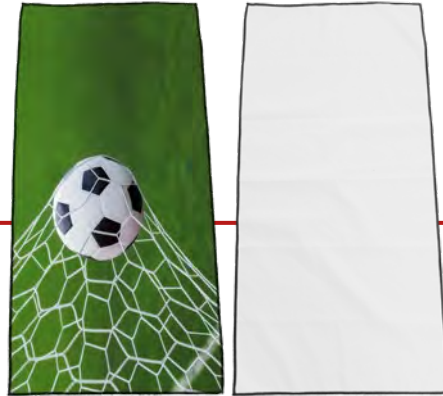
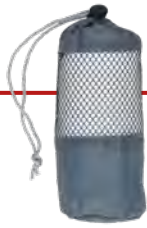

01044 Fitness towel „Sporty“ small

Whether for sports or on the beach: the small „Sporty“ fitness towel impresses with its „quick-drying“ feature. Packed in a polyester drawstring bag.

Piece(s)	1	100	500	1000
EUR	3.32	2.96	2.50	2.33

Textile/Polyester
 800 mm x 400 mm

100 Unit, Polyester etui + Polybag

01043 Fitness towel „Sporty“ large

Piece(s)	1	50	250	500
EUR	8.34	7.46	6.29	5.86

Textile/Polyester
 1400 mm x 700 mm

50 Unit, Polyester etui + Polybag

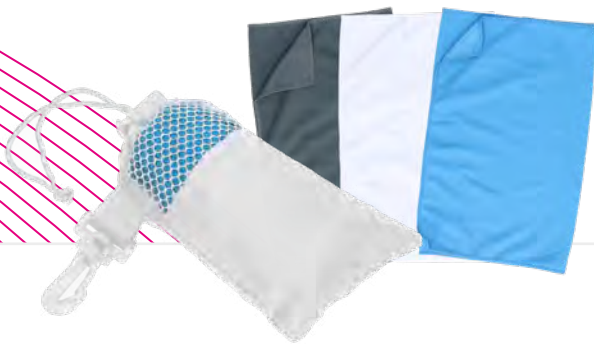

08932 Fitness towel „Cooling“

Smart fitness towel with cooling effect. Once soaked with cold water and wrung out, the cooling effect will unfold keeping the towel cold for several hours. In order to maintain the effect, just wet it again. Compact and easy to carry inside a bag with mesh on the top side. Including plastic snap hook as well as cord stopper for safe closure. Size of towel: 80 x 30 cm.

Piece(s)	1	100	500	1000
EUR	2.49	2.23	1.88	1.75

Textile/Polyester
 170 mm x 80 mm x 50 mm

200 Unit, Polybag



08378 Fitness towel „Keep Cool“

Great fitness towel with cooling effect. Slightly moistened with cold water and rolled-up around the neck it offers cooling for some time. Ideal for indoor and outdoor sports. Can be stored extremely compactly and it is easy to transport in a plastic box with screwable cap incl. snap hook function. Size of towel: 80 x 30 cm.

Piece(s)	1	100	500	1000
EUR	4.02	3.60	3.03	2.83

Textile/Polyester + Polyamide
 165 mm x 65 mm

100 Unit, Polybag



07465 Football net „All-Star“

Football net with fine meshed netting with cord pull and stopper made of black plastic. For up to size 5 match balls.

Piece(s)	1	500	1000	5000
EUR	1.49	1.33	1.12	1.05

Textile/Polypropylene
 370 mm x 350 mm

1000 Unit, Bulk



07246 Football goal „Pop Up“

Includes flexible wire frame and mesh material. Able to be collapsed via turning and then stored in its carrier. Bag features carrying band. Goal: 1200 x 750 x 450 mm

Piece(s)	1	25	100	250
EUR	23.31	20.86	17.58	16.40

Textile/Nylon

1200 mm x 750 mm x 360 mm

20 Unit, Polybag

Toys, 4+



Accessories in the handgrip.

06083 Hand pump

With 2 screw attachments for different valve sizes that stow away in the handle. Great for balls and standard valves on airbeds.

Piece(s)	1	100	500	1000
EUR	2.45	2.20	1.85	1.73

Plastic/Polypropylene
 205 mm x 56 mm x 33 mm

200 Unit, Polybag



01108 Football „Goldstar“

Machine-sewn. The size 5 football made from shiny PVC has 3 layers and 32 panels. The ball is 2.0 mm thick, with a butyl valve and latex bladder. The company address is printed on the valve. Weight: 300-350g.

Piece(s)	1	100	500	1000
EUR	8.47	7.59	6.39	5.96

Plastic/PVC
 Ø 220 mm

50 Unit, Polybag

Sport items



Image source: stock.adobe.com / Jacob Ammentorp Lund

01109 Football „League“

For all football fans! The size 5 football has 3 layers and 32 panels, including 6 double panels. The machine-sewn ball is made from smooth PVC with a butyl valve and latex bladder. The company address is printed on the valve. Weight: 280-300 g.

Piece(s)	1	100	500	1000
EUR	7.48	6.70	5.64	5.26

Plastic/PVC
 Ø 220 mm

50 Unit, Polybag
 Sport items



01105 Football „Champion“

A striking football! Machine-sewn PVC football in white, black and grey. Size 5. The ball has 3 layers and 32 panels, including a double panel. It is 2.0 mm thick, with a butyl valve and latex bladder. Weight: 330-360 g.

Piece(s)	1	100	500	1000
EUR	9.42	8.43	7.11	6.63

Plastic/PVC
 Ø 220 mm

50 Unit, Polybag
 Sport items



Also available as a matt version!



01107 Football „Classic“

Football in a retro design! The size 5 football has 3 layers and 32 panels, including 6 double panels. The machine-sewn ball is made from smooth PVC with a butyl valve and latex bladder. The company address is printed on the valve. Weight: 280-300 g.

Piece(s)	1	100	500	1000
EUR	7.39	6.61	5.57	5.20

Plastic/PVC
Ø 220 mm

50 Unit, Polybag
Sport items

01106 Football „Classico“, matte

Piece(s)	1	100	500	1000
EUR	7.11	6.37	5.36	5.01

Plastic/PVC
Ø 220 mm

50 Unit, Polybag
Sport items



01121 Football „Mini Carbon“

Silver football! The size 1 machine-sewn football made from PU-PVC-Shine has 3 layers and 32 panels, including one double panel. The 1.4 mm thick ball has a butyl valve, a latex bladder and the company name printed on the valve. Weight: 120-150 g.

Piece(s)	1	100	500	1000
EUR	7.19	6.43	5.42	5.06

Plastic/PU PVC
Ø 150 mm

100 Unit, Polybag
Sport items

01104 Football „Big Carbon“, large

Piece(s)	1	50	250	500
EUR	12.80	11.46	9.65	9.01

Plastic/PU PVC
Ø 220 mm

50 Unit, Polybag
Sport items



08944 Football „Germany“, small

Size 1, machine sewn, 32 panels, weight 180-190 g, 2 layers, Rubber bladder and rubber valve.

Piece(s)	1	100	500	1000
EUR	5.14	4.61	3.88	3.62

Plastic/PVC
 Ø 150 mm

100 Unit, Polybag
 Sport items

08086 Football „Germany“, big

Piece(s)	1	100	500	1000
EUR	6.26	5.60	4.72	4.40

Plastic/PVC
 Ø 220 mm

50 Unit, Polybag
 Sport items



01112 Football „Match“, small

Football in German colours! The machine-sewn size 1 football has 3c panel outlines in German colours. The ball is made from PVC and has 3 layers and 6 panels. With a butyl valve and latex bladder. Weight: 120-150 g.

Piece(s)	1	100	500	1000
EUR	6.47	5.79	4.88	4.55

Plastic/PVC
 Ø 150 mm

100 Unit, Polybag
 Sport items

01111 Football „Match“, large

Piece(s)	1	100	500	1000
EUR	7.15	6.40	5.39	5.03

Plastic/PVC
 Ø 220 mm

50 Unit, Polybag
 Sport items



08850 Wooden sledge „Snow“ small

Small wooden sledge made from European beech wood. The seat is made out of 100% polyester and is available in many colours. TÜV certified. Carrying weight: 90 kg

Price on request

Wood/Beech wood
700 mm x 260 mm

50 Unit, Bulk
Toys, 4+, 4

08851 Wooden sledge „Snow“ large

Price on request

Wood/Beech wood
1000 mm x 370 mm

36 Unit, Bulk
Toys, 4+, 4



07603 Sledge „Toboggan“

The cloth (100 % Polyester) covered seat top guarantees perfect sitting comfort. Supplied with rope for pulling.

Price on request

Wood
1120 mm x 155 mm x 355 mm

1 Unit, Bulk

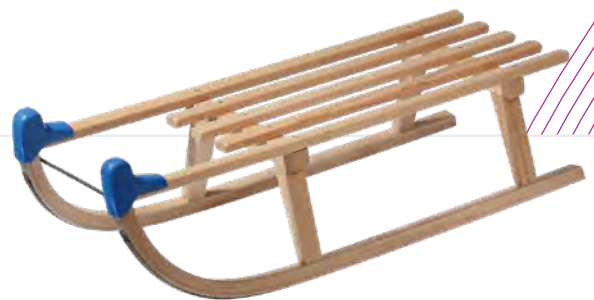

07973 Wooden sledge „Classic“

Sledge with slat seat, plastic covers on both front ends of sledge, runners and screws corrosion protected. You can fit a backrest to the sledge. Sledge also available in lengths 900, 1000, 1100 and 1200mm.

Price on request

Wood
800 mm x 370 mm x 260 mm

Bulk
Toys, 4+, 4



image source: shutterstock.com / Becky Weiss



01837 Snow glider „Olymp“

Snow gliding fun for all. Round snow glider made of sturdy plastic with 2 handles and elevated rim. Seating area can be finished with IMould.

Piece(s)	1	100	500	1000
EUR	7.67	6.85	5.72	5.33



Plastic/Polyethylene

15 Unit, Bulk

445 mm x 435 mm x 75 mm

Toys, 4+, 4

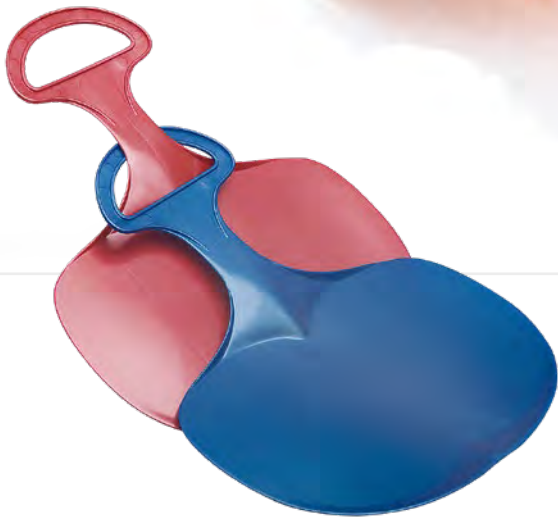

01830 Sledge „Standard“

Light, fast and resilient to cold. With handle and large advertising space.

Piece(s)	1	100	500	1000
EUR	2.69	2.41	2.03	1.90



Plastic/Polyethylene

80 Unit, Bulk

440 mm x 333 mm x 4 mm

Toys, 4+, 4



01835 Sledge „Glide Midi“

Light, fast and resilient to cold. With holder/carrying handle and large advertising space. IMould labelling only available for white model.

Piece(s)	1	100	500	1000
EUR	5.71	5.08	4.16	3.88



Plastic/Polyethylene

50 Unit, Bulk

520 mm x 345 mm x 38 mm

Toys, 4+, 4

PROMOTION FOR FANS.







Self-inflating.





08600 Noisemaking hose, self-inflating, „Germany“

Two self-inflating knocking tube sticks in Germany's colours. The foil of the sticks contains a granulate and a fluid bag. When hitting the bag slightly, it will burst and the stick inflates itself. The effect lasts for several weeks.

Piece(s)	1	500	1000	5000
EUR	1.13	1.01	0.85	0.79

 Plastic
  200 Unit, Polybag



 600 mm x 100 mm x 100 mm
  Fan items





07740 Noisemaking hose „Sticks“

2 inflatable hoses with self-sealing valve mechanism to prevent air escaping. A straw is provided for inflating and deflating.

Piece(s)	1	500	1000	5000
EUR	0.75	0.67	0.56	0.53

 Plastic/Polyethylene
  1000 Unit, Polybag

 590 mm x Ø 100 mm
  Fan items



09881 Rattle „Timber“

High volume advertising guaranteed! Traditional wooden rattle with 15cm rattle corpus. Standard type without imprint.

Piece(s)	1	100	500	1000
EUR	2.95	2.64	2.23	2.08

Wood
 100 Unit, Polybag
 146 mm x 145 mm x 35 mm
 Fan items



07320 Rattle „Nations - Timber“

Piece(s)	1	100	500	1000
EUR	3.06	2.74	2.31	2.15

Wood
 100 Unit, Polybag
 144 mm x 135 mm x 35 mm
 Fan items



03651 Rattle „Supreme“ Germany

Attractive advertising guaranteed! Made of plastic for extra loud rattle with 15 cm rattle corpus.

Piece(s)	1	500	1000	5000	
EUR	1.75	1.57	1.32	1.23	

Plastic/Polystyrene
 70 Unit, Bulk
 150 mm x 150 mm x 31 mm
 Fan items



03633 Rattle „Whistle“

2 in 1! Rattle with integrated whistle and small eye for attaching a cord.

Piece(s)	1	500	1000	5000	
EUR	1.28	1.14	0.96	0.90	

Plastic/Polystyrene
 150 Unit, Bulk
 130 mm x 60 mm x 26 mm
 Fan items

Image source: stock.adobe.com / LIGHTFIELD STUDIOS



07234 Whistle „Ref“

Piece(s)	1	500	1000	5000
EUR	0.86	0.76	0.62	0.57

Metal
 45 mm x Ø 20 mm

1000 Unit, Polybag
 Fan items



07415 Whistle „Goal“

Piece(s)	1	500	1000	5000
EUR	0.64	0.58	0.49	0.45

Plastic
 57 mm x 30 mm x 30 mm

1000 Unit, Polybag
 Fan items



03635 Whistle „Keyring“

Piece(s)	1	500	1000	5000
EUR	0.70	0.62	0.53	0.49

Plastic/Polystyrene
 80 mm x 40 mm x 8 mm

500 Unit, Bulk
 Fan items



09317 Whistle „Arena“

Piece(s)	1	100	500	1000
EUR	3.39	3.03	2.56	2.38

Metal
 78 mm x 30 mm x 10 mm

250 Unit, Individual carton + Polybag
 Fan items

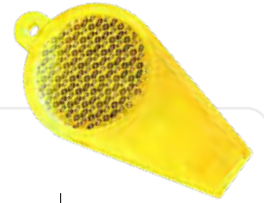

03634 Whistle „Reflector“

Piece(s)	1	500	1000	5000
EUR	0.72	0.65	0.55	0.51

Plastic/Polystyrene
 80 mm x 40 mm x 8 mm

1000 Unit, Bulk
 Fan items



03637 Whistle „Sport“ with cord

Small but loud. Available in a large selection of colours, with cord.

Piece(s)	1	500	1000	5000
EUR	0.43	0.39	0.33	0.30

Plastic/Polystyrene
 57 mm x 20 mm x 25 mm

800 Unit, Bulk
 Fan items

01364 Whistle „Sport“ with cord, duo-colour

Piece(s)	1	500	1000	5000
EUR	0.43	0.39	0.33	0.30

Plastic/Polystyrene
 57 mm x 20 mm x 25 mm

800 Unit, Bulk
 Fan items



07787 Car flag „Germany“

Includes black or white flag pole, 40cm length.

Piece(s)	1	500	1000	5000
EUR	1.32	1.17	0.99	0.92

- Textile/Polyester
- 470 mm x 290 mm x 1 mm
- 200 Unit, Bulk
- Fan items



01244 Car flag „Nations“

The flag for the car of every fan. Rod length: 45 cm. Flag dimensions: 30x46 cm.

Piece(s)	1	500	1000	5000
EUR	0.87	0.72	0.63	0.57

- Textile/Polyester
- 450 mm x 460 mm
- 200 Unit, Polybag
- Fan items



07774 Car flag „National flag - Germany“

Includes black holder. Please enquire for advertising options or read applicable legal documentation. Pole 40 cm length.

Piece(s)	1	500	1000	5000
EUR	0.94	0.84	0.71	0.66

- Textile/Polyester 100D
- 400 mm x 450 mm
- 200 Unit, Polybag
- Fan items



08630 Bicycle flag „Wheel“ Germany

Fan decoration for the bicycle. Polyester flag attached to a black plastic rod with integrated spring system and handlebar holder.

Piece(s)	1	500	1000	5000
EUR	0.95	0.85	0.72	0.67





- Textile/Polyester
- 295 mm x 215 mm x 15 mm
- 250 Unit, Polybag
- Fan items



07781 Flag „Nations - Germany“ 1,5 m

Giant German flag with 2 metal eyes for attaching to flag pole or for hanging on balconies or windows.

Piece(s)	1	100	500	1000
EUR	3.56	3.19	2.69	2.51





-  Textile/Polyester
-  200 Unit, Polybag
-  1500 mm x 880 mm x 1 mm
-  Fan items



07777 Flag „Germany“, wooden pole

German flag on wooden pole. Please enquire for advertising options or read applicable legal documentation. Pole: 60cm.

Piece(s)	1	500	1000	5000
EUR	1.09	0.97	0.82	0.76





-  Textile/Polyester
-  400 Unit, Polybag
-  600 mm x 300 mm x 1 mm
-  Fan items



07188 Chain of pennants „Germany“

The perfect accessory for decorating. 5m chain with 12 triangular pennants (20 x 30 cm) featuring horizontal black, red and yellow stripes.

Piece(s)	1	100	500	1000
EUR	3.15	2.82	2.37	2.21

-  Plastic
-  500 Unit, Polybag
-  5000 mm x 200 mm
-  Fan items



07798 Flower Necklace „Laola“

Piece(s)	1	500	1000	5000
EUR	1.00	0.90	0.76	0.71

Textile/Polyester
 Ø 280 mm

600 Unit, Polybag
 Fan items



07900 Flower necklace „Bavaria“

Piece(s)	1	500	1000	5000
EUR	0.92	0.82	0.69	0.65

Textile/Polyester
 Ø 300 mm

600 Unit, Polybag
 Fan items



08033 Flower necklace „Hawaii“

Piece(s)	1	500	1000	5000
EUR	0.82	0.73	0.62	0.57

Textile/Polyester
 900 mm x 45 mm

600 Unit, Polybag
 Fan items



01080 Floral neck garland „Flor“

Piece(s)	1	500	1000	5000
EUR	0.98	0.88	0.74	0.69

Textile/Polyester
 900 mm x 55 mm

600 Unit, Polybag
 Fan items



08049 Fun glasses „Germany“ with flower chain

Piece(s)	1	100	500	1000
EUR	3.96	3.55	2.99	2.79

Plastic/Polycarbonate
 405 mm x 150 mm x 50 mm

400 Unit, Polybag
 Fan items



08077 Felt hat „Seppel“

Piece(s)	1	100	500	1000
EUR	3.26	2.91	2.46	2.29

Textile/Polyester-felt
 100 Unit, Bulk
 250 mm x Ø 380 mm
 Fan items



07833 Sweat band „Hairy“

Piece(s)	1	100	500	1000
EUR	2.52	2.26	1.87	1.75

Textile/Polyester
 250 Unit, Polybag
 260 mm x 60 mm
 Fan items



08067 Straw hat „Texas“ Germany

Piece(s)	1	100	500	1000
EUR	3.34	2.99	2.52	2.35

Straw
 120 Unit, Bulk
 85 mm x Ø 335 mm



08483 Inflatable crown „Germany“

Piece(s)	1	100	500	1000
EUR	2.48	2.22	1.87	1.75

Plastic/PVC
 100 Unit, Polybag
 114 mm x Ø 200 mm
 Fan items



08022 „Fan scarf „Germany“““

Piece(s)	1	100	500	1000
EUR	10.30	9.22	7.76	7.24

Plastic/Polyacrylic
 100 Unit, Polybag
 1650 mm x 160 mm x 5 mm
 Fan items



07459 Sweatband „Nations - Germany“

Piece(s)	1	500	1000	5000
EUR	1.02	0.91	0.77	0.72

Textile/Cotton
 1000 Unit, Polybag
 70 mm x 70 mm
 Fan items



07270 Fan makeup „Germany“

Piece(s)	1	500	1000	5000
EUR	1.18	1.06	0.89	0.83

Plastic
 600 Unit, Plastic box + Polybag
 65 mm x 15 mm x 8 mm
 Fan items



07409 Fan make-up „Nations“ 2.0“

Piece(s)	1	500	1000	5000
EUR	1.22	1.09	0.92	0.86

Plastic
 600 Unit, Polybag
 27 mm x 11 mm x 42 mm
 Fan items

Camping and Outdoor.

- *Grills and accessories*
- *Garden*
- *Camping*
- *Loungers and chairs*
- *Beach mats*
- *Tents*
- *Handcart*
- *Tools*
- *Bicycle accessories*





01005 Cutter knife „Corte“

Sturdy cutter knife with aluminium cover and break-off blade. The slim design makes the knife comfortable to handle. With sharp, pointed blade and locking mechanism.

Piece(s)	1	100	500	1000
EUR	1.96	1.79	1.57	1.46

Plastic/ABS
 500 Unit, Polybag
 145 mm x 19 mm x 9 mm

NEW!



06317 Cutter knife „Carve“

This knife allows safe cutting with an automatic blade retract function. With lightweight plastic casing.

Piece(s)	1	500	1000	5000
EUR	0.96	0.87	0.79	0.68

Plastic/ABS
 500 Unit, Polybag
 125 mm x 25 mm x 10 mm



NEW!



06318 Cutter knife „Pro“

Professional cutter knife with automatic blade fixation and auto-loading spare blade store. Robust metal guide, M3 snap-off blades made of stainless steel, handle and spare blade store made of ABS and TPR. Advertising space in handle. Incl. 3 blades.

Piece(s)	1	100	500	1000
EUR	2.64	2.36	1.99	1.86

Plastic/ABS
 120 Unit, Polybag
 170 mm x 40 mm x 20 mm



06416 Cutter knife „Grip“

Sharp thing. Cutter knife with plastic housing and replaceable metal blade. In order to extend the blade the black grip part needs to be pushed forward. The blade can not be locked in place and can be extended only to the length necessary for cutting smoothly. This avoids severe injury.

Piece(s)	1	500	1000	5000
EUR	1.07	0.99	0.93	0.87

Plastic
 1200 Unit, Polybag
 103 mm x 30 mm x 10 mm

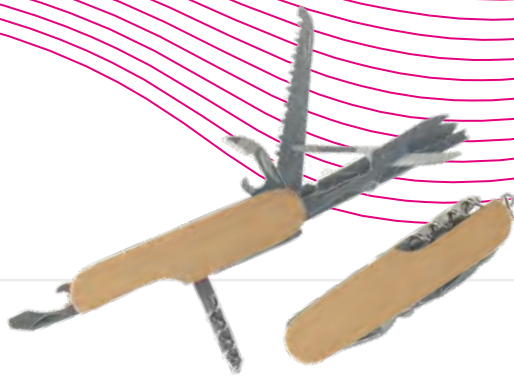

01131 Penknife „Wood“

Stainless steel penknife with a beech wood handle with eleven different tools: corkscrew, sewing awl, nail file, plastic cutter, Philips head screwdriver, knife, saw, fish deboner, scissors, tin opener and bottle opener with flat head screwdriver. Keyring included. Since wood is a natural product, variations in the colour and grain cannot be ruled out.

Piece(s)	1	100	500	1000
EUR	4.13	3.56	3.34	3.12

Metal/Stainless steel
 90 mm x 25 mm x 20 mm

100 Unit, Individual carton + Nylon etui



06328 Pocket knife „Steel“ large

11 functions: knife, bottleopener, corkscrew, tin opener, screwdriver, scissors, rasp, 2 saws, threader and awl.

Piece(s)	1	100	500	1000
EUR	5.06	4.53	3.82	3.56

Metal
 95 mm x 25 mm x 17 mm

120 Unit, Nylon-etui + Polybag



SALE!

09789 Pocket knife „Pocket“ small

5 functions: knife, bottleopener, corkscrew, tin opener and awl. With non slip rubber application.

Piece(s)	1	100	500	1000
EUR	2.13	1.84	1.70	1.64

Metal
 90 mm x 22 mm x 10 mm

240 Unit, Individual carton + Polybag



09456 Multitool „Pocket“

The most common bits always ready-to-hand. Multi tool with two slot screwdrivers and two Phillips screwdrivers inside a plastic slipcase (ABS) with finger hole. Thanks to the magnet the bits (stainless steel) can be easily inserted at the tip of the housing. Can also be fixed to the keyring.

Piece(s)	1	500	1000	5000
EUR	0.92	0.82	0.69	0.65

Plastic/ABS
 92 mm x 23 mm x 13 mm



500 Unit, Polybag



06349 Multi-tool „Legend“

One tool, eight functions. Robust multi tool with two saws, pliers, cross-point screwdriver, flat-bedded screwdriver, file, bottle opener, tin opener and knife. Packed individually in a nylon case.

Piece(s)	1	50	250	500
EUR	11.87	10.63	8.95	8.35

 Metal/Stainless steel
 100 mm x 45 mm x 20 mm



 50 Unit, Individual carton + Polybag



01133 Multitool „Wood“, small

Small all-rounder. The stainless steel penknife with a beech wood handle impresses with its various tools: saw, pliers, Philips head screwdriver, flat head screwdriver, small screwdriver, nail file, plastic cutter, bottle opener and knife. Since wood is a natural product, variations in the colour and grain cannot be ruled out.

Piece(s)	1	100	500	1000
EUR	6.42	5.99	5.74	5.35



 Metal/Stainless steel
 70 mm x 35 mm x 20 mm

 120 Unit, Individual carton + Nylon etui



01132 Multitool „Wood“, large

Piece(s)	1	50	250	500
EUR	7.71	7.42	7.05	6.58

 Metal/Stainless steel
 100 mm x 45 mm x 25 mm

 50 Unit, Individual carton + Nylon etui



01422 Ruler „Craft“ 2m

High-quality white folding ruler made of beech wood. High quality thanks to its metallic joints and visible studs. Length: 2m.

Piece(s)	1	100	500	1000
EUR	3.73	3.34	2.81	2.63

📦 Wood/Beech wood 📦 100 Unit, Bulk
 📏 2000 mm x 15 mm x 3 mm

01426 Ruler „Craft“ 2m colour

Piece(s)	1	100	500	1000
EUR	4.49	4.02	3.39	3.16

📦 Wood/Beech wood 📦 100 Unit, Bulk
 📏 2000 mm x 15 mm x 3 mm



06427 Folding ruler „Dimension“ 1 m

The key to it all. Handy plastic folding ruler 1 meter in length with 10 segments with 10 cm each.

Piece(s)	1	500	1000	5000
EUR	1.92	1.72	1.45	1.35

📦 Plastic/ABS 📦 60 Unit, Polybag
 📏 1300 mm x 14 mm x 25 mm

06316 Folding ruler „Dimension“ 2 m

Piece(s)	1	100	500	1000
EUR	2.08	1.87	1.57	1.47

📦 Plastic/ABS 📦 60 Unit, Polybag
 📏 2000 mm x 15 mm x 28 mm



06315 Key ring „Folding ruler“

Small plastic folding ruler always at hand. 50cm long, foldable, with practical key ring. Can be refined with UV digital printing when closed.

Piece(s)	1	500	1000	5000
EUR	1.64	1.47	1.24	1.15

Plastic/ABS 400 Unit, Polybag
 65 mm x 25 mm x 14 mm



01397 Spirit level „Misura“ 30 cm

Lightweight aluminium spirit level measuring 30 cm in length. Featuring plastic end caps, which protect the profile if bumped. With a horizontal, vertical and 45-degree level for all measurement requirements and a small hole for simple hanging. Easy to clean thanks to the smooth sides.

Piece(s)	1	100	500	1000
EUR	5.06	4.53	3.81	3.56

Metal/Aluminium 50 Unit, Polybag
 300 mm x 23 mm x 47 mm



05077 Bottle holder „Bicycle“

Bottle-holder for any bicycle. With two individually adjustable straps.

Piece(s)	1	500	1000	5000	
EUR	1.54	1.38	1.16	1.08	

Plastic/Polypropylene 80 Unit, Bulk
 75 mm x 90 mm x 140 mm



05121 Bottle holder „Flexi“

For cans and cups between 0.2 and 0.5 litres. Variable circumference. Suitable for virtually any kind of car - clip-on type.

Piece(s)	1	500	1000	5000	
EUR	0.80	0.71	0.60	0.56	

Plastic/Polypropylene 100 Unit, Bulk
 310 mm x 295 mm x 3 mm





09327 Bicycle Saddle Cover „Velo“

Protects the bicycle saddle from dirt and water splashes. The elasticated band makes it easy to attach the cover over the saddle. Due to the etui with push button and carabiner hook the cover can be transported also in wet condition, without touching other items.

Piece(s)	1	500	1000	5000
EUR	1.58	1.42	1.19	1.11

 Textile/Polyester 210T

 500 Unit, Polybag

 230 mm x 260 mm x 75 mm





01059 Hand cart „Wood“

Large hand cart made out of MDF panels, painted in red, sturdy 25 mm iron rod frame and handle with rubber coating. Easy to pull on account of the wide PU tyres and the steerable front axle. Max. load 80 kg. Individually boxed, requires assembly. Includes assembly manual in German/English.

Piece(s)	1	25	50	100
EUR	140.64	106.06	98.95	95.63

 Wood/Poplar wood

 1 Unit, Individual carton

 950 mm x 590 mm x 600 mm





08365 Handcart „Crease“

Foldable version of the typical handcart. The frame is made from steel, the cloth insert is made from tearproof 600D polyester. The handlebar is 53.5 cm long and can be attached to the cart. The two front wheels are freely movable which allow the handcart to be steered in a particularly flexible way. Is supplied unassembled.

Piece(s)	1	25	50	100
EUR	95.97	72.37	67.52	65.27

 Textile/Polyester 600D

 1 Unit, Individual carton + Polybag

 900 mm x 540 mm x 640 mm



01423 Grill scraper „BBQ“

Robust wooden scraper made of natural beechwood. This grill scraper is an alternative to dirty grill brushes or wire bristles that may fall off, or even end up on the grilled food or in your mouth. Hot bars on the grill grid burn into the wood slowly, scoring it slightly, and enhancing the cleaning effect. As the scraper adapts to the grill grid, it is suitable for all grill grids and can easily be reused.

Piece(s)	1	100	500	1000
EUR	3.47	3.11	2.62	2.44

Wood/Beech wood

30 Unit, Bulk

400 mm x 90 mm x 12 mm

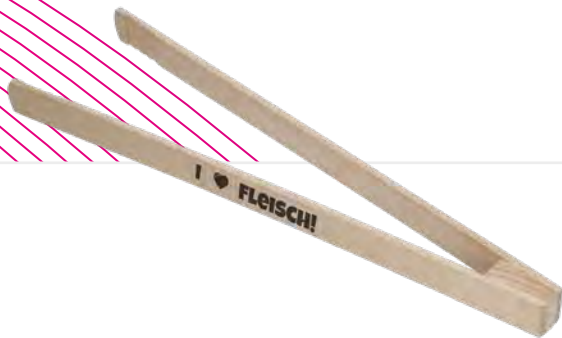

08665 Barbecue tong „Delano“

Light but robust barbecue tong made from unpainted beech wood. The plain and functional shape with four inboard grooves each guarantees safe turning of the grilled food. Perfectly suitable for CO2 laser finishing.

Piece(s)	1	500	1000	5000
EUR	1.09	0.98	0.82	0.77

Wood/Beech wood

480 Unit, Bulk

300 mm x 20 mm x 60 mm

NEW!

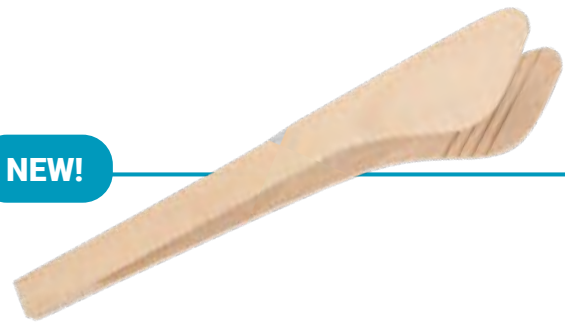

01796 Grill tongs „Woody“

For real BBQ pros! High-quality grill tongs made of beechwood. The functional shape with three grooves on the inside and large tong ends ensure that food can be turned securely. Also perfect for customisation with CO2 laser. Not dishwasher safe.

Piece(s)	1	100	500	1000
EUR	2.40	2.15	1.82	1.69

Wood/Beech wood

250 Unit, Bulk

300 mm x 21 mm



01630 Barbecue tongs with bottle opener „Opener“, 43cm

For barbecue pros! Barbecue tongs with integrated bottle opener. The slim and functional shape with four grooves on the inside ensures that food can be turned securely. Also perfect for customisation with CO2 laser. Not dishwasher safe.

Piece(s)	1	100	500	1000
EUR	3.24	2.90	2.44	2.28

Wood/Beech wood
430 mm

50 Unit, Bulk

NEW!



01872 Grillzange „Oak“

Premium-Grillzange aus geöltem Eichenholz mit Einkerbungen für eine komfortable Handhabung. Dank der Rillung an der Zangenspitze bleibt das Grillgut fest im Griff.

Stück	1	100	500	1000
EUR	7.05	6.31	5.32	4.96

Wood/Oakwood
390 mm x 20 mm

Bulk



NEW!

01718 Barbecue tongs with bottle opener „Opener“, 35 cm

For real barbecue professionals! Stainless steel barbecue tongs with integrated bottle opener. Thanks to the stainless steel material, you will enjoy these barbecue tongs for a long time. The tongs have plastic handles to protect your hands from the hot metal when grilling.

Piece(s)	1	100	500	1000
EUR	3.13	2.93	2.70	2.52

Metal/Stainless steel (430)
350 mm x 25 mm

48 Unit, Polybag



07482 Grill barbecue tongs „Asado“

Practical and flexible barbecue tongs made of steel with birch-wooden handles.

Piece(s)	1	100	500	1000
EUR	5.69	5.09	4.29	4.00

Wood/Birch wood 72 Unit, Polybag
 330 mm x 62 mm x 23 mm

NEW!



01868 Grill barbecue tongs „BBQ“

The classically curved grilling tongs are a handy assistant when grilling or in the kitchen. The notches on the handle and the spring tension ensure optimum handling. The ribbed and internally textured ends of the tongs ensure a safe grip on the food. In matte stainless steel.

Piece(s)	1	50	250	500
EUR	9.43	8.44	7.11	6.64

Metal/Stainless steel 100 Unit, Polybag
 345 mm x 70 mm



NEW!

01871 Barbecue set „Party“

Ideal for every grilling enthusiast. This essential grill set in stainless steel contains grilling tongs, grilling fork and grill turner, within an handy storage bag with handles.

Piece(s)	1	50	250	500
EUR	17.62	15.77	13.29	12.40

Metal/Stainless steel 24 Unit, Bulk
 385 mm x 110 mm

NEW!

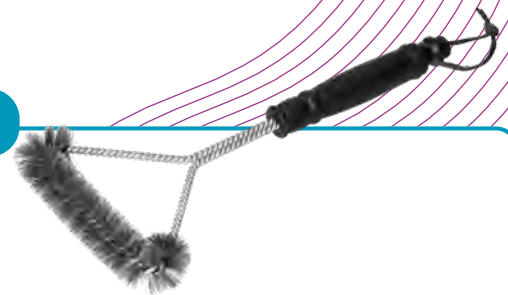

01869 Barbecue brush

Using the triangular wire grill brush the grill rack can be cleaned simply and effectively, to remove burned-on grease and other residues. Suitable for all types of grill. With hard-wearing stainless steel bristles, plastic handle and leather loop for handy attachment directly to the grill.

Piece(s)	1	100	500	1000
EUR	3.48	3.12	2.63	2.45

Metal/Stainless steel 24 Unit, Polybag
 330 mm x 180 mm



07056 Barbecue „Braai“

Mobile, foldable metal barbecue with grate and handles. Metal bottom serves as bowl for charcoal. Space saving and ideal for travelling.

Piece(s)	1	25	100	250
EUR	31.51	28.21	23.77	22.17

Metal
 320 mm x 320 mm x 240 mm

6 Unit, Individual carton + Polybag

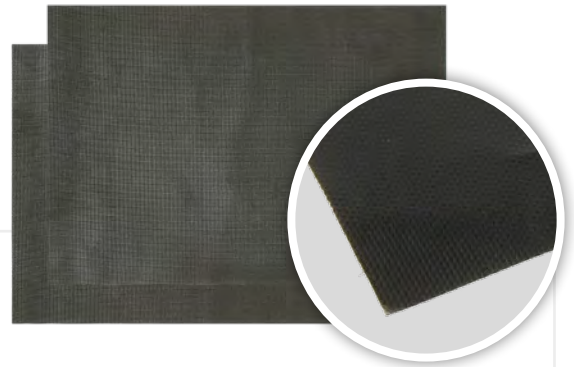

01243 Barbecue mat „BBQ“, 2-piece set

Keep things nice and clean at the barbecue with this 2-piece set. Practical barbecue underlay for gas and charcoal barbecues. Also ideal for use as baking paper or a baking mat in the oven. It is reusable and easy to clean with a soft cloth. Made from fibreglass with a Teflon coating.

Piece(s)	1	100	500	1000
EUR	5.64	5.04	4.25	3.97

Plastic
 297 mm x 210 mm

50 Unit, Individual carton + Polybag



NEW!

01873 Multifunctional box „Outdoor“

Flexible multi-function box for all kinds of outdoor uses. Whether for camping, picnicking, in the garden or by the pool, the box always makes a great impression. The box, made of sturdy and waterproof PVC has two practical carrying handles and folds down. Capacity: 15 litres.

Piece(s)	1	50	250	500
EUR	12.47	11.16	9.41	8.77

Plastic/PVC
 285 mm x 170 mm

20 Unit, Polybag



08931 Beer crate seat „Woody“

2 in 1. Robust beer crate seat made from unpainted beech wood of European origin that can also be used as chopping board. Suitable for all standard beer crates. On the bottom side there are two bars that guarantee a firm hold on the beer crate without slipping. Not suitable for cleaning in a dishwasher.

Piece(s)	1	50	200
EUR	12.94	11.51	11.14

Wood/Beech wood
 400 mm x 300 mm x 25 mm



10 Unit, Bulk



07590 Leisure chair „Sunshine - Germany“



Easy to set up. Just click together ... done. The cloth covered backrest offers a comfortable sitting position. Ideal for open air events.

Price on request

 Wood
 530 mm x 360 mm x 40 mm

07601 Leisure chair „Sunshine“

Price on request



 Wood/Beech wood  Polybag
 710 mm x 360 mm x 80 mm



01008 Camping chair „Safari“

Sit comfortably outdoors too. Foldable camping chair with sturdy metal frame and integrated cup holder in the armrest. Packed in a practical bag with shoulder strap. Maximum carrying weight: 100 kg.

Piece(s)	1	25	100	250
EUR	21.35	19.11	16.10	15.02

 Textile/Polyester 600D  6 Unit, Bulk
 890 mm x 500 mm x 890 mm

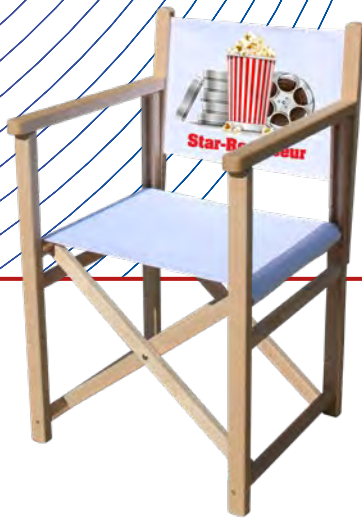

SALE!

06110 Director's chair „Star“

Foldable solid director's chair made of European beech wood and with polyester cover. The big backrest is ideal for your promotional message. Loading capacity: approx. 95 kg

Piece(s)	1	25	50	100
EUR	76.63	57.79	53.93	52.11

📦 Wood/Beech wood
📏 830 mm x 520 mm x 80 mm

📦 25 Unit, Polybag



09278 Beach chair „Classy“

Trendy adjustable beach chair featuring a lightweight aluminium framework with replaceable polyester cover. Available in silver and black colour. Carrying Weight: 120 kg.

Price on request

📦 Metal/Aluminium
📏 1140 mm x 40 mm x 600 mm

📦 1 Unit, Polybag



08885 Beach chair „Recreo“

The ideal deck chair for a little break. The deck chair is made of European beech wood and includes a polyester cover for a better resting comfort. The height is adjustable using the bars on the bottom part. Carrying weight: 70 kg

Price on request

📦 Wood/Beech wood
📏 905 mm x 30 mm x 485 mm

📦 50 Unit



07602 Beach chair „Harmony“

Easy handling and perfect seating position for relaxing due to cloth covered backrest. Height adjustable clicks into rail on underside.

Price on request

📦 Wood/Beech wood
📏 1200 mm x 560 mm x 70 mm



📦 Polybag



08884 Beach chair „Piccola“

Our little one. Deck chair made of European beech wood with polyester cover and solid locking mechanism. With it's loading capacity of approx. 35 kg it is ideal for kids or as means of decoration.

Price on request



 Wood/Beech wood
  150 Unit
 725 mm x 450 mm x 30 mm



08494 Beach chair „Chillout“

Be it the beach, the balcony or the garden - focus on chilling. Adjustable deck chair made from beech wood with polyester cover that can be individually printed on. The cover can be removed for washing.



Piece(s)	1	25	50	100
EUR	45.75	39.45	38.88	38.30

 Wood/Beech wood
  1 Unit, Polybag
 1380 mm x 590 mm x 60 mm



08808 Beach chair „Chillout Deluxe“

Piece(s)	1	25	50	100
EUR	73.47	65.75	55.40	51.68

 Wood/Beech wood
  2 Unit, Polybag
 1480 mm x 610 mm x 60 mm

Toys and Games.

- Inflatable
- Building bricks
- Dragons
- Social and travel games
- Yo-yos
- Crumpled crumbs
- Puzzles
- Roundabout
- Miniature vehicles
- Plush
- Cue balls
- Table- and mini kicker
- Throwing, catching and hitting





01315 Flying disc „Space Flyer 18“

Piece(s)	1	500	1000	5000	
EUR	0.94	0.84	0.71	0.66	

Plastic/Polypropylene 200 Unit, Bulk
 20 mm x Ø 177 mm Toys, 4+, 6



01327 Flying disc „Space Flyer 21“

Piece(s)	1	500	1000	5000	
EUR	1.38	1.23	1.04	0.97	

Plastic/Polypropylene 100 Unit, Bulk
 24 mm x Ø 220 mm Toys, 4+, 6



01316 Flying disc „Space Flyer 24“

Piece(s)	1	100	500	1000	
EUR	2.47	2.21	1.87	1.74	

Plastic/Polypropylene 60 Unit, Bulk
 30 mm x Ø 238 mm Toys, 4+, 6

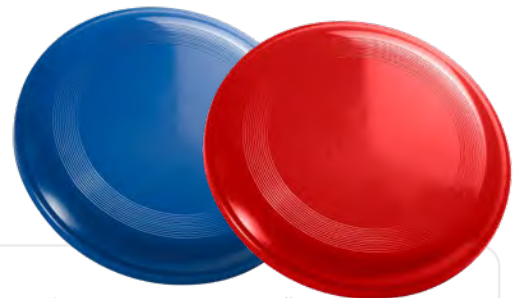

01317 Flying disc „Space Flyer 26“

Piece(s)	1	100	500	1000	
EUR	3.20	2.86	2.41	2.25	

Plastic/Polypropylene 60 Unit, Bulk
 30 mm x Ø 260 mm Toys, 4+, 6



01321 Flying disc „Space Flyer 22“

Game and fun for more movement. Top seller! Stackable, with ring structure. IMould labelling possible.

Piece(s)	1	500	1000	5000	
EUR	1.00	0.89	0.75	0.70	

Plastic/Polypropylene 100 Unit, Bulk
 24 mm x Ø 216 mm Toys, 4+, 6



Also available in bio-plastic or with components made from recycled mask material!



11321 Eco-Flying Disc „Space Flyer 22“

Piece(s)	1	500	1000	5000	
	1.73	1.54	1.30	1.21	

01758 Flying disc „Space Flyer 22“, upcycling

Piece(s)	1	500	1000	5000	
EUR	1.00	0.89	0.75	0.70	

11321
 24 mm x Ø 216 mm
 100 Unit, Bulk

01758
 24 mm x Ø 216 mm
 100 Unit, Bulk



01331 Flying disc „Elastic Flyer“

Price on request



Plastic/TPE
24 mm x Ø 220 mm

100 Unit, Bulk
Toys, 4+, 6



01328 Flying disc „Ufo 22“

Piece(s)	1	500	1000	5000
EUR	1.04	0.93	0.78	0.73



Plastic/Polypropylene
19 mm x Ø 220 mm

150 Unit, Bulk
Toys, 4+, 6



01300 Flying disc „Mini 10“

Piece(s)	1	500	1000	5000
EUR	0.47	0.42	0.35	0.33



Plastic/Polypropylene
11 mm x Ø 98 mm

700 Unit, Bulk
Toys, 4+, 6



01323 Flying disc „Professional 23“

Piece(s)	1	500	1000	5000
EUR	2.13	1.91	1.61	1.50



Plastic/Polypropylene
31 mm x Ø 230 mm

50 Unit, Bulk
Toys, 4+, 6



01185 Throwing game „Mini pinball 50“

Piece(s)	1	500	1000	5000
EUR	0.36	0.32	0.27	0.25

Plastic/Polypropylene
6 mm x Ø 46 mm

1000 Unit, Bulk
Toys, 4+, 6

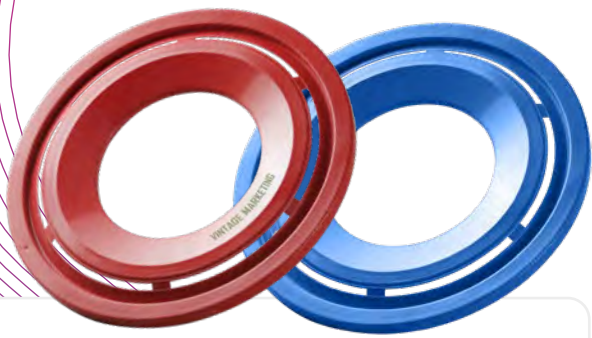

01350 Flying disc „Super Flyer Maxi 30“

Piece(s)	1	500	1000	5000	
EUR	1.93	1.73	1.46	1.36	

Plastic/Polypropylene 50 Unit, Bulk
 15 mm x Ø 290 mm Toys, 4+, 6

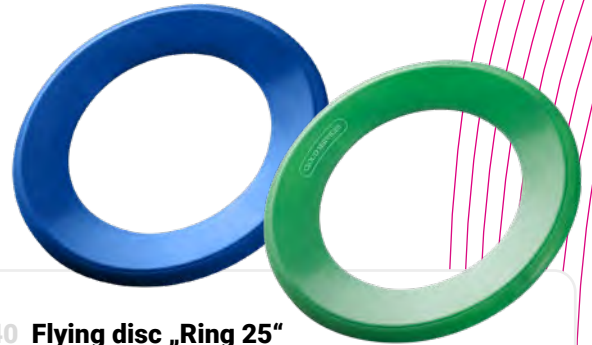

01340 Flying disc „Ring 25“

Piece(s)	1	500	1000	5000	
EUR	0.96	0.86	0.72	0.68	

Plastic/Polypropylene 150 Unit, Bulk
 10 mm x Ø 250 mm Toys, 4+, 6

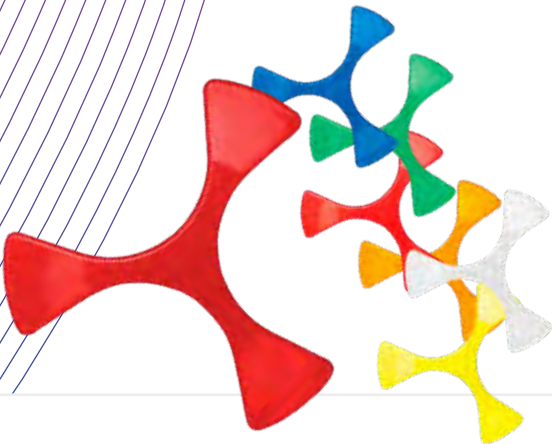

01341 Flying disc „Heli 30“

Piece(s)	1	500	1000	5000	
EUR	1.37	1.22	1.03	0.96	

Plastic/Polypropylene 120 Unit, Bulk
 11 mm x Ø 290 mm Toys, 4+, 6



01368 Boomerang „Mini“

Piece(s)	1	500	1000	5000	
EUR	1.02	0.91	0.77	0.72	

Plastic/Polystyrene 200 Unit, Bulk
 320 mm x 34 mm x 4 mm Toys, 4+, 6



01370 Boomerang „Maxi“

Piece(s)	1	500	1000	5000	
EUR	2.33	2.08	1.75	1.64	

Plastic/Polystyrene 60 Unit, Bulk
 410 mm x 43 mm x 6 mm Toys, 4+, 6



01726 Beach ball set „Sun“

Great fun for children and adults at the beach, in the park or in the swimming pool guaranteed! Beach game set consisting of 2 rackets and a soft PU foam game ball. The sturdy plastic rackets can easily withstand a game in the water

Piece(s)	1	100	500	1000	
EUR	10.77	9.64	8.12	7.58	

Plastic/ABS 20 Unit, Cotton bag
 377 mm x 245 mm



01420 Table tennis set „Robust“

Roughened bat surface to drive the ball. The set includes 2 bats with grip grooves and 1 soft ball.

Piece(s)	1	100	500	1000	
EUR	3.98	3.56	3.00	2.80	

Plastic/Polypropylene 50 Unit, Polybag
 265 mm x 160 mm x 40 mm Toys, 6+, 1

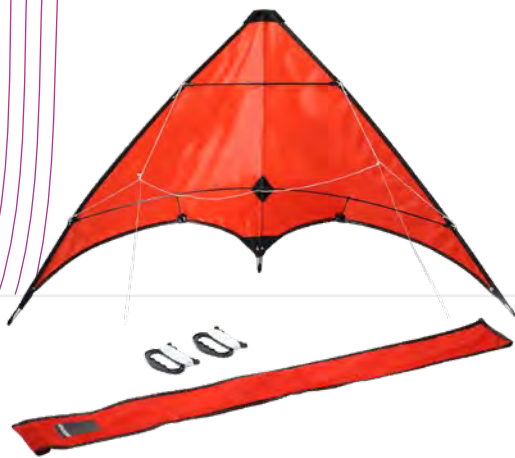

05010 Kite „Volare“

Send your ad into the sky. Fantastic kite made of nylon with fibreglass frame, 2 plastic handles and 30m of line. Includes nylon sleeve with hook- and-loop fastener for easy stowing of the whole kite. Advertising space on the sleeve and on the kite itself.

Piece(s)	1	100	500	1000
EUR	5.23	4.68	3.95	3.68

Textile/Nylon 100 Unit, Nylon-etui + Polybag
 1250 mm x 530 mm x 15 mm Toys, 6+, 3

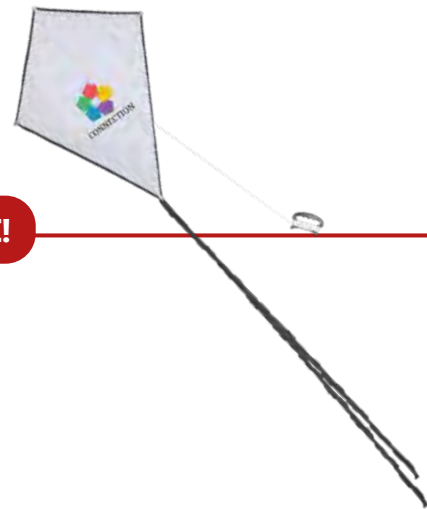

SALE!

06099 Kite „Diamond“

The advertising message is in the air. Prettier, bigger Dragon in traditional Polyester form with a black border and ultra light, robust fibre-glass frame. Including a black tail and a plastic reel with an 20 m long cord.

Piece(s)	1	100	500	1000
EUR	1.83	1.64	1.39	1.29

Textile/Polyester 200 Unit, Polybag
 695 mm x 580 mm x 4 mm Toys, 6+, 3



01209 Inflatable crown „Corona“

Small storage space, big effect. Inflatable crown in gold, for a regal party.

Piece(s)	1	100	500	1000
EUR	2.26	2.03	1.71	1.59

Plastic/PVC 16P

114 mm x Ø 200 mm

100 Unit, Polybag

Fan items



08070 Water Polo ball „Midi“ transparent

The classic among the inflatable promotional articles. Medium-sized water polo ball made of coloured-transparent 15 P polyvinyl chloride (PVC). With minimal space requirements for storage, this article offers maximum fun during recreation time and success in advertising.

Piece(s)	1	500	1000	5000
EUR	1.17	1.04	0.88	0.82

Plastic/PVC 15P

Ø 250 mm

300 Unit, Polybag

Toys, 3+, 1, 5



07430 Waterball „Football“, small

The football for playing in water. A small PVC ball with 6 white panels and 1 colored panel, black print in football style.

Piece(s)	1	100	500	1000
EUR	2.53	2.26	1.91	1.78

Plastic/PVC 7P

Ø 400 mm

100 Unit, Polybag

Toys, 3+, 1, 5





07514 Mini-Softball

Soft ball made of polyurethane, filled with foam material and approx. 10 cm in diameter.

Piece(s)	1	100	500	1000
EUR	3.16	2.83	2.38	2.22

Plastic/Artificial leather
 Ø 100 mm

100 Unit, Polybag
 Toys, 3+, 1



small

medium



large

01190 Football „Giant“, small

Small, soft ball in the design of a normal football. With a PVC bladder for a good bounce and a soft fleece cover for even more fun, with a reduced risk of injury.

Piece(s)	1	100	500	1000
EUR	3.32	2.97	2.50	2.35

Textile/Fleece
 Ø 200 mm

200 Unit, Polybag
 Toys, 1+

07439 Football „Giant“

Piece(s)	1	100	500	1000
EUR	7.96	7.12	6.00	5.60

01189 Football „Giant“, medium

Piece(s)	1	100	500	1000
EUR	4.38	3.90	3.29	3.07

07439
 Ø 500 mm
 50 Unit, Polybag

01189
 Ø 300 mm
 200 Unit, Polybag



06202 Jumping ball „Football“, small

Small ball in soccer ball look. Made of rubber with high bounce.

Piece(s)	1	500	1000	5000
EUR	1.21	1.08	0.91	0.85

Plastic/Natural Rubber
 Ø 55 mm

288 Unit, Polybag
 Toys, 3+



06444 Jumping ball „Basketball“ 2.0

Small ball in basketball look. Made of rubber - very bouncy.

Piece(s)	1	500	1000	5000
EUR	1.41	1.26	1.06	0.99

Plastic/Material Rubber
 Ø 63 mm

288 Unit, Polybag
 Toys, 3+, 1

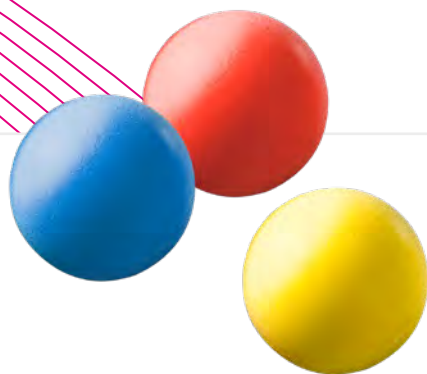

01225 Softball „Mini 42“

Ultra soft softball made of PU foam. Ideal for ball gamers.

Piece(s)	1	500	1000	5000
EUR	0.73	0.65	0.55	0.51

Plastic/PU foam
 Ø 42 mm

1000 Unit, Bulk
 Toys, 3+, 1



01240 Softball „Midi 70“

Ultra soft softball made of PU foam. Ideal for ball gamers.

Piece(s)	1	500	1000	5000
EUR	0.99	0.89	0.75	0.70

Plastic/PU foam
 Ø 70 mm

250 Unit, Bulk
 Toys, 3+, 1



01533 Cornhole Set „To Go“

Fun To Go, for young and old alike Miniature cornhole game set for indoor and outdoor use, and for on the go. The set contains a sturdy plastic board (game board, 10x20 cm) with fold-out feet, as well as 2 blue and 2 red bags (filled bean bags, 3.5x3.5 cm) The bags are filled with plastic granulate and weigh approx. 7 g per unit. The underside of the game features a flap for the secure storage of the bags during transportation.

Piece(s)	1	100	500	1000
EUR	4.06	3.64	3.06	2.86

Plastic/PP + PS
 200 mm x 100 mm

100 Unit, Individual carton
 Toys, 4+, 1



07375 Table football „Goal“

Fun guaranteed! Table football with balls and players. With glass holder, counter mechanism, and rounded edges. Makes any game an experience. The table is supplied disassembled.

Piece(s)	1	25	50	100
EUR	483.62	444.93	415.14	401.22

Wood
 1400 mm x 920 mm x 770 mm

1 Unit, Individual carton
 Sport items



07620 Table football „Mini Soccer“

For a little game. Small table football with 6 players and a total of 2 balls. Ideal for travelling.

Piece(s)	1	25	100	250
EUR	24.05	21.53	18.14	16.92

Wood
 500 mm x 310 mm x 100 mm

4 Unit, Individual carton + Polybag
 Toys, 6+, 1



01117 Yo-yo „Heart“

Piece(s)	1	500	1000	5000	EUR
EUR	0.48	0.43	0.36	0.34	

Plastic/Polystyrene 250 Unit, Bulk
 56 mm x 63 mm x 23 mm Toys, 6+



01120 Yo-yo „Pro-Motion“

Piece(s)	1	500	1000	5000	EUR
EUR	0.46	0.41	0.35	0.32	

Plastic/Polystyrene 250 Unit, Bulk
 30 mm x Ø 55 mm Toys, 6+



01110 Yo-yo „Jeans“

Piece(s)	1	500	1000	5000	EUR
EUR	0.42	0.38	0.32	0.30	

Plastic/Polystyrene 250 Unit, Bulk
 21 mm x Ø 42 mm Toys, 6+

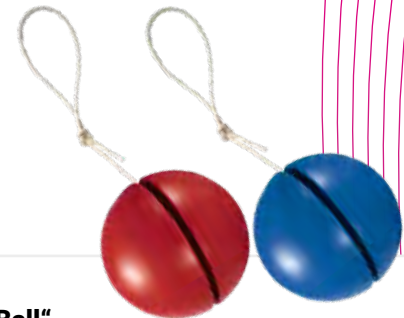

01140 Yo-yo „Ball“

Piece(s)	1	500	1000	5000	EUR
EUR	1.97	1.76	1.48	1.39	

Plastic/Polystyrene 120 Unit, Bulk
 Ø 58 mm Toys, 6+



01150 Yo-yo „Tricky Colour“

With trick characteristics and printable single-colour disks on sides.

Piece(s)	1	500	1000	5000	EUR
EUR	2.38	2.13	1.80	1.68	

Plastic/Polystyrene 180 Unit, Bulk
 37 mm x Ø 56 mm Toys, 6+



01154 also customisable with digital print insert.

01154 Yo-yo „Tricky“

Piece(s)	1	500	1000	5000	EUR
EUR	2.45	2.19	1.85	1.72	

Plastic/Polystyrene 180 Unit, Bulk
 37 mm x Ø 56 mm Toys, 6+



image source: istockphoto.com / Ingorthand

01135 Yo-yo „Professional“

Piece(s)	1	500	1000	5000
EUR	1.66	1.48	1.25	1.16

Plastic/Polystyrene 250 Unit, Bulk
 24 mm x Ø 59 mm Toys, 6+



08753 Yo-yo „Light“

Piece(s)	1	500	1000	5000
EUR	1.32	1.19	1.00	0.93

Plastic 300 Unit, Polybag
 35 mm x Ø 55 mm Toys, 6+



08755 Yo-Yo „Timber“

Piece(s)	1	500	1000	5000
EUR	0.99	0.89	0.75	0.70

Wood/Lotus tree wood 400 Unit, Bulk
 25 mm x Ø 51 mm Toys, 4+



01113 Yo-yo „Mini-Disc“

Flat, light yo-yo with large advertising space - perfect as a giveaway with your mail shot.

Piece(s)	1	500	1000	5000	
EUR	0.42	0.38	0.32	0.30	

Plastic/Polystyrene 500 Unit, Bulk
 9 mm x Ø 54 mm Toys, 6+

01114 Yo-yo „Maxi-Disc“

Piece(s)	1	500	1000	5000
EUR	0.69	0.62	0.52	0.48

Plastic/Polystyrene 400 Unit, Bulk
 14 mm x Ø 57 mm Toys, 6+



01179 Top „Top“

Piece(s)	1	500	1000	5000	
EUR	0.32	0.28	0.24	0.22	

Plastic/Polystyrene
 29 mm x Ø 41 mm

1000 Unit, Bulk
 Toys, 3+



02010 Top „Classic wood“

Piece(s)	1	500	1000	5000
EUR	0.89	0.80	0.66	0.62

Wood/Beech wood
 38 mm x Ø 33 mm

4000 Unit, Bulk
 Toys, 3+



03431 Top „Hurricane“

Piece(s)	1	500	1000	5000
EUR	1.14	1.02	0.86	0.80

Plastic/Polystyrene
 33 mm x Ø 40 mm

1000 Unit, Bulk
 Toys, 3+



01175 Top „Stand-up small“

The stand-up top will stand on its head if spun correctly!

Piece(s)	1	500	1000	5000	
EUR	0.20	0.18	0.15	0.14	

Plastic/Polystyrene
 29 mm x Ø 24 mm

1500 Unit, Bulk
 Toys, 3+

01178 Top „Stand-up large“

Piece(s)	1	500	1000	5000	
EUR	0.29	0.26	0.22	0.21	

Plastic/Polystyrene
 39 mm x Ø 33 mm



1000 Unit, Bulk
 Toys, 3+



SALE!

01017 Cuddle cloth „Cuddle“

The cute cuddle cloth makes babies' happy - soft cuddle cloth made of super soft Velboa plush in the versions „Rabbit“, „Cow“ and „Bear“. The cute arms and ears animate babies to touch, feel and cuddle, so that the cuddly soft cloth will not be let go anymore. It has been CE-tested and can be printed over a large area on the „belly“ by using roll transfer.

Piece(s)	1	100	500	1000
EUR	4.06	3.63	3.06	2.86

 Textile/Plush
 240 mm x 260 mm



 200 Unit, Polybag
 Toys, 0+





06005 Rubber duck „Squeeze“

Trendy rubber duck with typical shape. Other colours and shapes on request.

Piece(s)	1	500	1000	5000
EUR	1.27	1.13	0.96	0.89

 Plastic/PVC 6P
 80 mm x 78 mm x 70 mm



 102 Unit, Polybag
 Toys, 0+





05502 Game box „Building blocks“ coloured

Colourful wooden building blocks for children. Packed in a plastic box that is also perfect for other uses. Individual IMould labelling possible on box.

Piece(s)	1	100	500	1000
EUR	7.67	6.87	5.78	5.40

 Wood/Beech wood
 160 mm x 110 mm x 50 mm

 20 Unit, Bulk
 Toys, 1+



03030 Travel game „Peg game mini“

2-sided travel game „Play along“ and „Checkers“ in a folding plastic case which is also used to store the pieces and dice.

Piece(s)	1	100	500	1000
EUR	4.39	3.93	3.31	3.09

Plastic/Polypropylene
 100 Unit, Bulk
 110 mm x 110 mm x 17 mm
 Toys, 6+, 1



03150 Brain teaser „4 Wins“

Tactical game for 2 players. With removable board and cups to hold chips.

Piece(s)	1	100	500	1000
EUR	4.16	3.72	3.14	2.92

Plastic/Polystyrene
 100 Unit, Individual carton
 129 mm x 95 mm x 105 mm
 Toys, 6+, 1



03020 Motif puzzle „Einstein“

Puzzle packed individually in a folding case. IMould labelling possible on lid. Individual colour combinations on request. 5 additional motifs available.

Piece(s)	1	100	500	1000
EUR	2.95	2.65	2.23	2.08

Plastic/Polypropylene
 300 Unit, Bulk
 84 mm x 84 mm x 9 mm
 Toys, 6+, 1



03212 Coin Dish

Flat plastic tray for collecting small change. Ideal when playing cards.

Piece(s)	1	500	1000	5000
EUR	0.62	0.56	0.47	0.44

Plastic/Polypropylene
 250 Unit, Bulk
 21 mm x Ø 100 mm
 Toys, 3+





03230 Dice cup „Combi“ with 5 dice

20 exciting dice games possible. 5 wooden dice in locking plastic cup.

Piece(s)	1	100	500	1000
EUR	3.33	2.98	2.51	2.34

📦 Plastic/Polyethylene

📏 83 mm x Ø 72 mm

📦 100 Unit, Individual carton

⚠️ Toys, 6+, 1



03226 Dice game „The big throw“ in case

Game board, game instructions and 5 coloured wooden dice. Packed in re-sealable plastic sleeve. Ideal for travelling.

Piece(s)	1	250	500	1000
EUR	3.69	3.28	2.66	2.47

📦 Plastic/PVC

📏 207 mm x 88 mm x 10 mm

📦 90 Unit, Plastic box

⚠️ Toys, 6+, 1



03227 Dice game „The big throw“ in plastic box

Piece(s)	1	100	500	1000
EUR	3.75	3.36	2.83	2.64

📦 Plastic/Polypropylene

📏 206 mm x 88 mm x 16 mm

📦 70 Unit, Plastic box

⚠️ Toys, 6+, 1



03440 Pussycat puzzle „Ball Pyramid“

Funny give-away puzzles. Skill and combinatory skills promise success.

Piece(s)	1	500	1000	5000
EUR	1.56	1.39	1.17	1.10

Plastic/Polystyrene
 350 Unit, Bulk
 36 mm x 36 mm x 36 mm
 Toys, 6+, 1



03488 Pussycat game „Catch the ball“

Funny give-away puzzles. Skill and combinatory skills promise success.

Piece(s)	1	500	1000	5000
EUR	0.73	0.65	0.55	0.51

Plastic/Polystyrene
 400 Unit, Bulk
 43 mm x 43 mm x 10 mm
 Toys, 4+



04069 Puzzle game „Football“

Football look puzzle game. With 1 ball and 2 integrated goals.

Piece(s)	1	500	1000	5000	
EUR	1.02	0.91	0.77	0.72	

Plastic/Polystyrene
 500 Unit, Bulk
 70 mm x 45 mm x 10 mm
 Toys, 4+



04074 Puzzle game set „Traffic signs“

Comprising 6 different puzzle games. Shape, colour and picture insert customisable.

Piece(s)	1	100	500	1000	
EUR	4.79	4.29	3.62	3.37	

Plastic/Polystyrene
 167 Unit, Polybag
 Toys, 4+



03505 Puzzle game „Mini round“

Shape, colour and picture insert customisable.

Piece(s)	1	500	1000	5000
EUR	0.71	0.63	0.53	0.50

Plastic/Polystyrene
9 mm x Ø 44 mm

1000 Unit, Bulk
Toys, 4+



03508 Puzzle game „Midi round“

Shape, colour and picture insert customisable.

Piece(s)	1	500	1000	5000
EUR	0.68	0.61	0.51	0.48



Plastic/Polystyrene
11 mm x Ø 60 mm

400 Unit, Bulk
Toys, 4+



03515 Puzzle game „Rectangle“

Shape, colour and picture insert customisable.

Piece(s)	1	500	1000	5000
EUR	0.91	0.81	0.68	0.64



Plastic/Polystyrene
82 mm x 65 mm x 7 mm

400 Unit, Bulk
Toys, 4+



03595 Puzzle game „Duo Labyrinth“

A tricky dexterity puzzle game in size 65 x 65 x 8 mm. Circular labyrinth on the front and rectangular labyrinth on the back.

Piece(s)	1	500	1000	5000
EUR	1.08	0.97	0.82	0.76



Plastic/Polystyrene
65 mm x 65 mm x 8 mm

500 Unit, Bulk
Toys, 4+



03045 Sliding puzzle „Frame 15“

Tricky sliding puzzle with 15 moving puzzle pieces and 1 stopper. Large and impressive advertising space.

Piece(s)	1	500	1000	5000
EUR	0.87	0.77	0.63	0.59

- Plastic/Polystyrene
- 500 Unit, Polybag
- 90 mm x 75 mm x 5 mm
- Toys, 6+, 1



03461 Sliding puzzle „Frame 62“

Tricky sliding puzzle with 62 moving parts and 1 stopper. Individual printing up to 4 colours possible. Large and impressive advertising space.

Piece(s)	1	100	500	1000
EUR	4.49	4.02	3.39	3.16

- Plastic/Polystyrene
- 130 Unit, Bulk
- 150 mm x 125 mm x 8 mm
- Toys, 6+, 1



03462 Sliding puzzle „Space 15“

Tricky sliding puzzle with 15 moving parts and 1 stopper. Individual printing up to 4 colours possible. Large and impressive advertising space.

Piece(s)	1	500	1000	5000	
EUR	1.43	1.28	1.08	1.00	

- Plastic/Polystyrene
- 450 Unit, Bulk
- 75 mm x 75 mm x 8 mm
- Toys, 6+, 1



03463 Sliding puzzle „Frame 16“

Tricky sliding puzzle with 16 moving parts and 1 stopper. Individual printing up to 4 colours possible. Large and impressive advertising space.

Piece(s)	1	500	1000	5000	
EUR	1.51	1.35	1.14	1.06	

- Plastic/Polystyrene
- 400 Unit, Bulk
- 92 mm x 75 mm x 8 mm
- Toys, 6+, 1



03464 Sliding puzzle „Space 14“

Tricky sliding puzzle with 14 moving parts and 1 stopper. Individual printing up to 4 colours possible. Large and impressive advertising space.

Piece(s)	1	500	1000	5000
EUR	1.66	1.49	1.25	1.17

📦 Plastic/Polystyrene

📏 150 mm x 46 mm x 8 mm

📦 340 Unit, Bulk

⚠️ Toys, 6+, 1



06715 Miniature vehicle „Mercedes Truck“ mini

Miniature trucks on 1:87 scale with many details. Custom colours on request. Towing vehicle made of cast metal with plastic trailer. Packed in blister carton.

Piece(s)	1	100	500	1000
EUR	2.58	2.39	2.20	2.05

📦 Plastic

📏 110 mm x 30 mm x 46 mm

📦 160 Unit, PVC box

⚠️ Toys, 6+, 1



SALE!



06716 Miniature vehicle „Mercedes Truck“

Miniature trucks on 1:87 scale with many details. Custom colours on request. Towing vehicle made of cast metal with plastic trailer. Packed in blister carton.

Piece(s)	1	100	500	1000
EUR	2.19	2.07	2.00	1.87

📦 Plastic

📏 195 mm x 30 mm x 45 mm

📦 160 Unit, PVC box

⚠️ Toys, 6+, 1



01124 Miniature truck „Mercedes Actros MP4“

Mini truck with loads of detail. This miniature vehicle consists of a metal cabin with a plastic trailer. The large surfaces are perfectly suited for communicating your advertising message.

Piece(s)	1	100	500	1000
EUR	3.28	2.93	2.47	2.31

📦 Plastic

📏 190 mm x 28 mm x 43 mm

📦 160 Unit, PVC box

⚠️ Toys, 6+, 1







SALE!



06103 Miniature vehicle „Volvo Truck“

Miniature truck with three axles in the scale of 1:87 with many details. Special colours upon request. Towing vehicle made from metal injection moulding with trailer made from plastics. Blister board packaging.

Piece(s)	1	100	500	1000
EUR	2.27	2.13	2.03	1.89





-  Plastic
-  160 Unit, PVC box
-  190 mm x 30 mm x 45 mm
-  Toys, 6+, 1



06714 Miniature vehicle „MAN Truck“

Miniature trucks on 1:87 scale with many details. Custom colours on request. Towing vehicle made of cast metal with plastic trailer. Packed in blister carton.

Piece(s)	1	100	500	1000
EUR	2.67	2.47	2.28	2.12





-  Plastic
-  160 Unit, PVC box
-  192 mm x 30 mm x 44 mm
-  Toys, 6+, 1



06754 Miniature vehicle „Coach“

Miniature coach on 1:87 scale with many details. Custom colours on request. Perfect as a team coach! Packed in blister carton.

Piece(s)	1	100	500	1000
EUR	3.05	2.83	2.60	2.42

-  Plastic
-  160 Unit, PVC box
-  140 mm x 30 mm x 40 mm
-  Toys, 6+, 1







SALE!



05369 Miniature vehicle „Delivery van“

Miniature delivery van on 1:87 scale with many details. Custom colours on request. Packed in blister carton.

Piece(s)	1	100	500	1000
EUR	2.27	2.13	2.06	1.92

-  Metal
-  300 Unit, PVC box
-  65 mm x 20 mm x 25 mm
-  Toys, 6+, 1

Travel and Safety.

- *Identity card and card sleeves*
- *Car accessories*
- *Ice scraper*
- *Functional and warning vests*
- *Pillows*
- *Parking discs*
- *Ponchos*
- *Reflectors*
- *Tyre tread gauge*
- *Travel sets*
- *Travel Accessories*
- *Umbrellas*
- *Snaps*
- *Sun visors*



01011 Ice scraper „TopGrip - Clean Vision“

A cleverly designed ice scraper - MADE IN GERMANY. The shape of the ice scraper makes it comfortable to use. The anti-slip material on the handle helps to efficiently and quickly scrape off any ice on the windshield. The jagged edges on the top side of the ice scraper easily help to remove thick layers of ice.

Piece(s)	1	100	500	1000	
EUR	3.65	3.27	2.75	2.57	

Plastic/Polystyrene
 220 mm x 100 mm x 27 mm

40 Unit, Bulk

01012 Ice scraper „TopGrip - 3D Vision“

Piece(s)	5000	10000	
EUR	3.42	3.28	

01013 Ice scraper „TopGrip - Digital Vision“

Piece(s)	1	100	500	1000	
EUR	4.69	4.20	3.54	3.30	

01012
 215 mm x 100 mm x 27 mm
 40 Unit, Bulk

01013
 220 mm x 100 mm x 27 mm
 40 Unit, Bulk

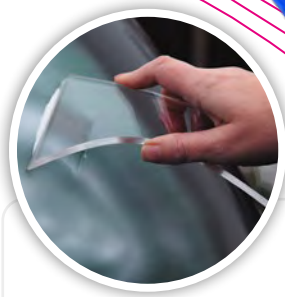

04318 Ice scraper „Ergonomic“

Very sturdy ice-scraper with elegant curve. At one end has a smooth scraping edge and at the other end has scraping teeth for stubborn ice on the windows of the car. Due to its unusual shape, the ice scraper fits perfectly in the hand, thus increases the impact. The rounded edges will help avoid uncomfortable pressure points on the hand and scratches on the glass.

Piece(s)	1	500	1000	5000
EUR	2.21	1.98	1.67	1.55

Plastic/Polystyrene
192 mm x 93 mm x 24 mm

100 Unit, Bulk



04303 Ice scraper „Ice witch“

Ergonomic shape and stable. Plastic ice scraper with smooth scraping edge, scraping teeth and handy grip.

Piece(s)	1	500	1000	5000
EUR	1.46	1.30	1.10	1.03



Plastic/Polystyrene
215 mm x 107 mm x 29 mm

100 Unit, Bulk



version with water scraper

04228 Ice scraper „Easy“ without water scraper

Easier scraping. Ice scraper with handle, scraping teeth, smooth scraper edge and hole for hanging up.

Piece(s)	1	500	1000	5000
EUR	1.70	1.52	1.28	1.19



Plastic/Polystyrene
227 mm x 99 mm x 19 mm

100 Unit, Bulk

04229 Ice scraper „Easy“ with water scraper

Piece(s)	1	500	1000	5000
EUR	2.02	1.80	1.52	1.42



Plastic/Polystyrene
227 mm x 100 mm x 19 mm

100 Unit, Bulk

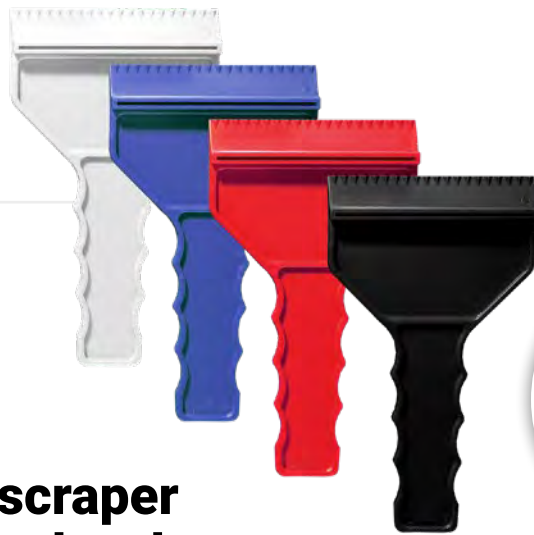

version with water scraper

04232 Ice scraper „Grip“ without water scraper

Grippy. Ice scraper with scraping teeth and handy grip.

Piece(s)	1	500	1000	5000	
EUR	0.62	0.56	0.47	0.44	

Plastic/Polystyrene 100 Unit, Bulk
 175 mm x 100 mm x 18 mm

04234 Ice scraper „Grip“ with water scraper

Piece(s)	1	500	1000	5000	
EUR	0.86	0.77	0.65	0.61	

Plastic/Polystyrene 100 Unit, Bulk
 175 mm x 100 mm x 23 mm



version with water scraper

04223 Ice scraper „Square“ without water scraper

Handy, flat ice scraper with scraping teeth and smooth scraper edge.

Piece(s)	1	500	1000	5000	
EUR	0.66	0.59	0.49	0.46	

Plastic/Polystyrene 250 Unit, Bulk
 100 mm x 100 mm x 3 mm

04224 Ice scraper „Square“ with water scraper

Piece(s)	1	500	1000	5000	
EUR	0.93	0.83	0.70	0.65	

Plastic/Polystyrene 250 Unit, Bulk
 100 mm x 103 mm x 3 mm



04225 Ice scraper „Square“

Piece(s)	1	500	1000	5000	
EUR	0.79	0.70	0.59	0.55	

Plastic/Polystyrene 250 Unit, Bulk
 147 mm x 103 mm x 3 mm



04227 Ice scraper „Triangle“

Piece(s)	1	500	1000	5000	
EUR	0.28	0.25	0.22	0.20	

Plastic/Polystyrene 500 Unit, Bulk
 120 mm x 116 mm x 3 mm



05415 Ice scraper „Trapeze“

Piece(s)	1	500	1000	5000	
EUR	0.71	0.64	0.54	0.50	

Plastic/Polystyrene 250 Unit, Bulk
 123 mm x 110 mm x 3 mm



04231 Ice scraper „Logo“

Piece(s)	1	500	1000	5000	
EUR	1.01	0.91	0.77	0.71	

Plastic/Polystyrene 300 Unit, Bulk
 114 mm x 120 mm x 3 mm



04304 Ice scrape „Delta“

Piece(s)	1	500	1000	5000	
EUR	0.61	0.55	0.46	0.43	

Plastic/Polystyrene 250 Unit, Bulk
 135 mm x 135 mm x 3 mm



04310 Ice scrape „Arch“

Piece(s)	1	500	1000	5000	
EUR	0.84	0.75	0.63	0.59	

Plastic/Polystyrene 250 Unit, Bulk
 100 mm x 132 mm x 4 mm



04239 Ice scraper „Santa“

Funny, moulded ice scraper with scraping teeth and single colour standard Santa imprint.

Piece(s)	1	500	1000	5000
EUR	0.98	0.88	0.74	0.69

Plastic/Polystyrene
 250 Unit, Bulk
 123 mm x 99 mm x 3 mm



04237 Ice scraper „Snowman“

Moulded ice scraper with scraping teeth and four colour standard snowman imprint.

Piece(s)	1	500	1000	5000
EUR	2.09	1.87	1.57	1.47

Plastic/Polystyrene
 250 Unit, Bulk
 132 mm x 90 mm x 3 mm



04236 Ice scraper „Polar bear“

Moulded ice scraper with scraping teeth and single colour standard polar bear imprint.

Piece(s)	1	500	1000	5000
EUR	1.02	0.91	0.77	0.72

Plastic/Polystyrene
 250 Unit, Bulk
 130 mm x 109 mm x 3 mm



04238 Ice scraper „Penguin“

Moulded ice scraper with scraping teeth and single colour standard penguin imprint.

Piece(s)	1	500	1000	5000
EUR	0.97	0.87	0.73	0.68

Plastic/Polystyrene
 250 Unit, Bulk
 124 mm x 93 mm x 3 mm



04235 Ice scraper „Truck“

Made of stable plastic. Ice scraper in the shape of a truck with scraping teeth. Full colour or transparent available.

Piece(s)	1	500	1000	5000	
EUR	0.68	0.61	0.51	0.48	

Plastic/Polystyrene 250 Unit, Bulk
 131 mm x 97 mm x 3 mm



04305 Ice scrape „Wave“

Ice scraper with unusual scrape, 2 scraping edges and large advertising space. One smooth scraping edge and one edge with teeth.

Piece(s)	1	500	1000	5000	
EUR	0.78	0.70	0.59	0.55	

Plastic/Polystyrene 100 Unit, Bulk
 116 mm x 124 mm x 24 mm



04320 Ice scraper „Smartphone“ short scraping edge

Elegant ice scraper in the shape of a smartphone, made from sturdy and transparent polystyrene with short scraping edge at the bottom. Thanks to the handy format and the rounded edges the force will be transmitted optimally, while the ice scraper rests comfortably in the hand.

Piece(s)	1	500	1000	5000	
EUR	1.60	1.43	1.21	1.13	

Plastic/Polystyrene 100 Unit, Bulk
 156 mm x 70 mm x 5 mm



04321 Ice scraper „Smartphone“ long scraping edge

Elegant ice scraper in the shape of a smartphone, made from sturdy and transparent polystyrene with long scraping edge on the side. Thanks to the handy format and the rounded edges the force will be transmitted optimally, while the ice scraper rests comfortably in the hand.

Piece(s)	1	500	1000	5000	
EUR	1.61	1.44	1.21	1.13	

Plastic/Polystyrene 100 Unit, Bulk
 143 mm x 83 mm x 5 mm



04226 Ice scraper „All round“

Versatile and convenient. Ice scraper with water scraper, brush and long handle.

Piece(s)	1	250	500
EUR	5.01	4.65	3.95

Plastic/Polystyrene
 50 Unit, Bulk
 395 mm x 133 mm x 15 mm



06019 Ice scraper „Bi-Part“

The perfect combination in snow and ice. Ice scraper with long handle and smooth scraping edge, combined with a practical handbrush. Can be used separately or assembled. The curved carving edge makes ice scraping easier.

Piece(s)	1	100	500	1000
EUR	4.29	3.85	3.20	2.99

Plastic/ABS
 60 Unit, Polybag
 405 mm x 90 mm x 100 mm



06003 Ice scraper „Vision“ with glove

Protection against ice and cold. Lined gloves with soft fleece inner and removable ice scraper with grip and smooth scraping edge.

Piece(s)	1	100	500	1000
EUR	2.41	2.16	1.82	1.70

Plastic
 100 Unit, Polybag
 300 mm x 160 mm x 25 mm



06004 Ice scraper „Crystal“ with glove

Even better protection against the cold for your hands. Lined gloves with soft fleece inner and removable ice scraper with grip, elastic band and smooth scraping edge.

Piece(s)	1	100	500	1000
EUR	3.12	2.79	2.35	2.19

Plastic
 50 Unit, Polybag
 380 mm x 200 mm x 50 mm



04245 Parking disk „Basic“

Plastic parking disk with flat scraping edge and water scraper. IMould labelling possible. Complies with paragraph 42 StVO (German highway code). For use between -10°C and +60°C.

Piece(s)	1	500	1000	5000	
EUR	1.48	1.33	1.12	1.04	

Plastic/Polystyrene 100 Unit, Bulk
 155 mm x 119 mm x 7 mm



04248 Parking disk „Professional“

Plastic parking disk with flat scraping edge, scraping teeth and water scraper. 2 holders for shopping cart chip and tyre tread measuring gauge on rear - filled as standard. Complies with paragraph 42 StVO (German highway code). For use between -10°C and +60°C.

Piece(s)	1	500	1000	5000	
EUR	2.27	2.03	1.71	1.60	

Plastic/Polystyrene 100 Unit, Bulk
 155 mm x 119 mm x 7 mm



07629 Parking disc „Display Cleaner“

One product with four functions. Parking disc made from plastic with scraping against against frozen windows, integrated shopping trolley chip and cleaner for cleaning different displays of smartphones, navigation systems etc. The display cleaner must be stored on the back of the parking disc in order to protect it against dirt. Complies with paragraph 42 StVO (German highway code). For use between -10°C and +60°C.

Piece(s)	1	100	500	1000
EUR	2.06	1.85	1.56	1.45

Plastic/Polystyrene 200 Unit, Polybag
 155 mm x 120 mm x 17 mm





04251 Parking disk „Prime“ with chip

Plastic parking disk with flat scraping edge, scraping teeth and water scraper. 3 holders for shopping cart chips or Euro coins on rear. Supplied with 3 coloured chips as standard, custom colours on request. Complies with paragraph 42 StVO (German highway code). For use between -10°C and +60°C.

Piece(s)	1	500	1000	5000	
EUR	1.79	1.57	1.27	1.16	

Plastic/Polystyrene
 155 mm x 119 mm x 7 mm

100 Unit, Bulk

04250 Parking disk „Prime“ without chip

Piece(s)	1	500	1000	5000	
EUR	1.60	1.43	1.21	1.13	

Plastic/Polystyrene
 155 mm x 119 mm x 7 mm

100 Unit, Bulk



04253 Parking disk „Euro“ with chip

Plastic parking disk with flat scraping edge, scraping teeth and water scraper. 3 holders for shopping 1 or 2 Euro coins on rear. Supplied with 3 coloured chips as standard, custom colours on request. Complies with paragraph 41 StVO (German highway code). For use between -10°C and +60°C.

Piece(s)	1	500	1000	5000	EUR
EUR	1.66	1.49	1.25	1.17	

Plastic/Polystyrene 100 Unit, Bulk
155 mm x 119 mm x 7 mm



04254 Parking disk „Euro“ without chip

Piece(s)	1	500	1000	5000	EUR
EUR	2.07	1.85	1.56	1.45	

Plastic/Polystyrene 100 Unit, Bulk
155 mm x 119 mm x 7 mm



05400 Cardboard parking disk „Board“

Light, environmentally friendly, and protects you against parking tickets. Made of 100% recycled paper. Complies with paragraph 42 StVO (German highway code).

Piece(s)	1	500	1000	5000
EUR	0.43	0.39	0.33	0.32

Paper/Cardboard 500 Unit, Bulk
150 mm x 110 mm x 1 mm

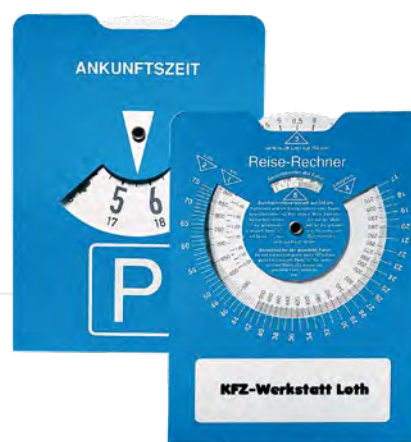

05401 Cardboard parking disk „Travel calculator“

Keep an eye on your petrol expenses. Parking disk with travel expense calculator on rear turn the disk to calculate your travel expense. Complies with paragraph 41 StVO (German highway code).

Piece(s)	1	500	1000	5000
EUR	0.49	0.42	0.36	0.34

Paper/Cardboard 500 Unit, Bulk
150 mm x 110 mm x 1 mm

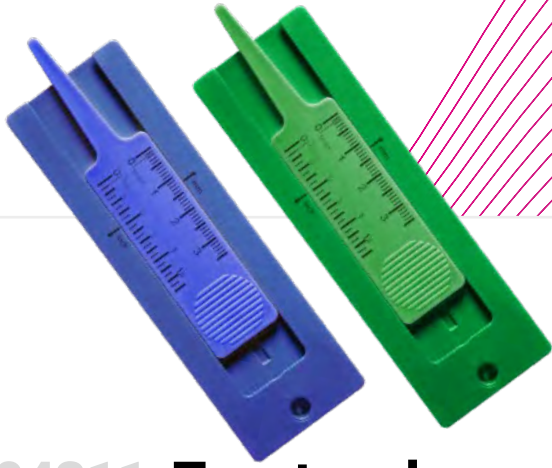

04311 Tyre tread measuring device „Truck“

Safety first. Indispensable tyre tread gauge with inch and millimetre scale for precise checking of your tyre tread.

Piece(s)	1	500	1000	5000
EUR	1.37	1.23	1.04	0.97

Plastic/ABS

500 Unit, Bulk

110 mm x 35 mm x 6 mm



04302 Key fob „Tyre tread measuring device“

Always at hand. Tyre tread gauge with eye for attaching to keyring. Without keyring

Piece(s)	1	500	1000	5000
EUR	0.74	0.66	0.56	0.52



Plastic/Polystyrene

2000 Unit, Bulk

60 mm x 22 mm x 4 mm



04301 Tyre tread measuring device „Card“

Tyre tread gauge in cheque card format with millimetre scale and removable shopping cart chip. Includes eye for fastening to keyring.

Piece(s)	1	500	1000	5000
EUR	1.23	1.11	0.93	0.87



Plastic/Polystyrene

600 Unit, Bulk

82 mm x 51 mm x 4 mm



04300 Tyre tread measuring device „Profi“

Small and versatile. Tyre tread gauge with millimetre scale, keyring and disposable gloves.

Piece(s)	1	500	1000	5000
EUR	1.42	1.27	1.07	1.00

Plastic/Polystyrene

500 Unit, Bulk

65 mm x 30 mm x 14 mm



04075 Tyre tread measuring device „Chip“

2 useful accessories together. Shopping cart chip in plastic with the minimum tyre tread depth for your winter and summer tyres. Simply insert the chip into the tread and check if the line is covered.

Piece(s)	1	500	1000	5000	
EUR	0.30	0.26	0.22	0.21	

Plastic/Polystyrene
 2 mm x Ø 23 mm

10000 Unit, Bulk

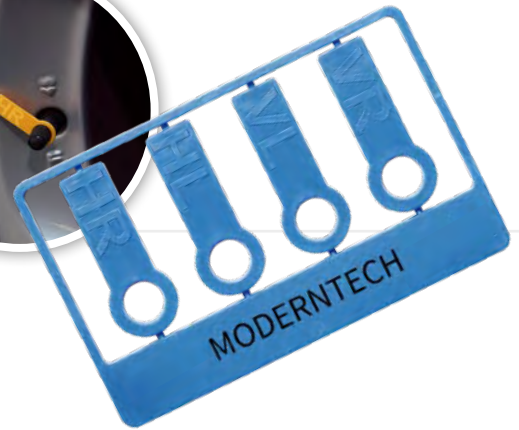
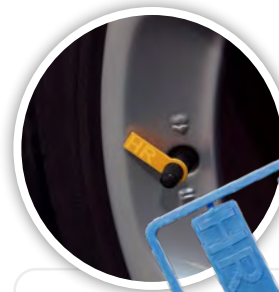

04242 Tyre marker set „Car“

For labelling stored tyres. Simply place on the valve and your tyres are labelled. Saves time-consuming marking with chalk. Ideal e.g. for workshops and hobby car mechanics.

Piece(s)	1	500	1000	5000	
EUR	0.33	0.30	0.25	0.24	

Plastic/Polystyrene

87 mm x 55 mm x 2 mm

1000 Unit, Bulk



05406 Permit scraper

The multitool for your car. Ice scraper, permit scraper, belt cutter, clip for parking ticket and tyre tread gauge. Practical to use with locking mechanism for scraper to protect against injury.

Piece(s)	1	100	500	1000
EUR	3.03	2.72	2.29	2.14

Plastic/Polystyrene

70 mm x 100 mm x 12 mm

200 Unit, Bulk



05411 Vignette scraper „Allround“

Ideal accessory for the car. Plastic ice scraper in the size of a credit-card with removable trolley chip and metallic scraper edges for removing vignettes and other stickers.

Piece(s)	1	500	1000	5000
EUR	2.23	2.00	1.68	1.57

Plastic/ABS

85 mm x 55 mm x 5 mm

250 Unit, Polybag





Image source: stock.adobe.com / Fred DE BAILLIENCOURT



09404 Safety vest „Standard“ case

Safety vest with highly reflective reflector stripes for optimal protection during darkness. Standard size XXL. Available in nylon case as a standard. Complies with requirements of EU directive 2016/425 and standard EN ISO 20471:2013+A1:2016, Class II. Safety vests consisting of safety vest standard - 09004. Silk screen vests can be modified in black, silver or reflecting silver only. Made from 100% polyester.



Piece(s)	1	5000
EUR	2.76	2.53

 Textile/Polyester
 650 mm x 630 mm x 2 mm

 100 Unit, Polyester etui + Polybag

09060 Safety vest „Standard“ 5-part set in case

Piece(s)	1	5000
EUR	12.76	12.00

 Textile/Polyester
 250 mm x 210 mm x 85 mm

 20 Unit, Plastic box



09004 Safety vest „Standard“ poly bag

Safety vest with highly reflective reflector stripes for optimal protection during darkness. Standard size XXL. Available in poly bags as a standard. Complies with requirements of EU directive 2016/425 and standard EN ISO 20471:2013+A1:2016, Class II. Silk screen vests can be modified in black, silver or reflecting silver only. Made from 100% polyester.

Piece(s)	1	5000
EUR	2.12	1.93

Textile/Polyester 100 Unit, Polybag
 635 mm x 660 mm x 3 mm



09994 Safety vest set „Compact“

Ideal for all two-seaters. Two safety vests with highly reflective reflector stripes for optimal protection during darkness. Standard size XXL. Handily packaged in black nylon bag. Complies with requirements of EU directive 2016/425 and standard EN ISO 20471:2013+A1:2016, Class II. Safety vest set consisting of 2x reflective vest standard 09004. Silk screen vests can be modified in black, silver or reflecting silver only. Made from 100% polyester.

Piece(s)	1	50	250	500
EUR	9.22	8.25	6.96	6.49

Textile/Polyester 50 Unit, Polybag
 185 mm x 40 mm x 100 mm

09053 Safety vest „Kids“

More safety for children. Highly reflective reflector stripes for optimal protection during darkness and twilight. Standard size M. To pull over clothing. Complies with requirements of EU directive 2016/425, Class II and standard EN 1150:1999.

Piece(s)	1	5000
EUR	2.04	1.92

Textile/Polyester 100 Unit, Polybag
 510 mm x 525 mm x 5 mm





03777 Reflector „Heart“*

Piece(s)	1	500	1000	5000	
EUR	1.03	0.92	0.77	0.72	

Plastic/Polymethyl methacrylate 500 Unit, Polybag
 58 mm x 68 mm x 8 mm

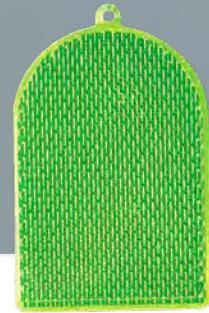

03798 Reflector „Arch“*

Piece(s)	1	500	1000	5000
EUR	1.26	1.13	0.95	0.89

Plastic/Polymethyl methacrylate 500 Unit, Polybag
 78 mm x 50 mm x 7 mm



03780 Reflector „Round“*

Piece(s)	1	500	1000	5000	
EUR	0.98	0.87	0.74	0.69	

Plastic/Polymethyl methacrylate 250 Unit, Polybag
 7 mm x Ø 63 mm



03783 Reflector „Shirt“*

Piece(s)	1	500	1000	5000
EUR	1.16	1.03	0.87	0.81

Plastic/Polymethyl methacrylate 500 Unit, Polybag
 65 mm x 55 mm x 4 mm



03784 Reflector „Lightbulb“*

Piece(s)	1	500	1000	5000	
EUR	1.22	1.09	0.92	0.86	

Plastic/Polymethyl methacrylate 500 Unit, Polybag
 66 mm x 55 mm x 4 mm

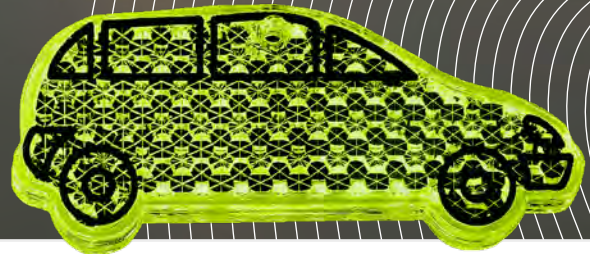

03779 Reflector „Car“*

Piece(s)	1	500	1000	5000	
EUR	1.24	1.11	0.94	0.87	

Plastic/Polymethyl methacrylate 400 Unit, Polybag
 79 mm x 31 mm x 8 mm

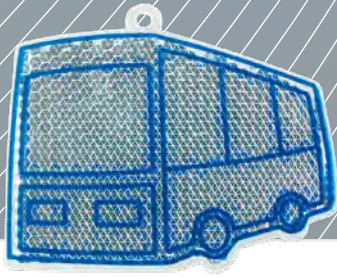

03793 Reflector „Bus“*

Piece(s)	1	500	1000	5000	
EUR	1.26	1.13	0.95	0.89	

Plastic/Polymethyl methacrylate 500 Unit, Polybag
 63 mm x 46 mm x 8 mm



03787 Reflector „Dragon“*

Piece(s)	1	500	1000	5000	
EUR	1.23	1.10	0.93	0.87	

Plastic/Polymethyl methacrylate 500 Unit, Polybag
 62 mm x 52 mm x 8 mm



03789 Reflector „Ghost“*

Piece(s)	1	500	1000	5000	
EUR	1.67	1.49	1.25	1.17	

Plastic/Polymethyl methacrylate 500 Unit, Polybag
 58 mm x 52 mm x 8 mm



03776 Reflector „Bear“*

Piece(s)	1	500	1000	5000	
EUR	0.99	0.88	0.74	0.69	

Plastic/Polymethyl methacrylate 500 Unit, Polybag
 65 mm x 45 mm x 9 mm



03799 Reflector „Piggy“*

Piece(s)	1	500	1000	5000	
EUR	0.97	0.87	0.73	0.69	

Plastic/Polymethyl methacrylate 500 Unit, Polybag
 65 mm x 45 mm x 7 mm



03800 Reflector „Polar bear“*

Piece(s)	1	500	1000	5000	
EUR	0.99	0.88	0.74	0.69	

Plastic/Polymethyl methacrylate 400 Unit, Polybag
 71 mm x 55 mm x 7 mm

* This reflector is not a toy and not suitable as a warning accessory.



03782 Reflector „Cyclist“*

Plastic figures with integrated reflector and holders for bicycle spokes. Bear, mouse and clown version available as standard. Special designs of other figures on request. This article is a reflective advertising tag.

Piece(s)	1	500	1000	5000	
EUR	0.49	0.44	0.37	0.35	

Plastic/Polypropylene 500 Unit, Bulk
 90 mm x 100 mm x 5 mm



03774 Reflector „Traffic light“*

3-part reflector in traffic light colours. With plastic clip on rear for attaching to shoulder bags or clothing. This item is a reflective advertising tag.

Piece(s)	1	500	1000	5000	
EUR	1.13	1.01	0.85	0.80	

Plastic/Polymethyl methacrylate 500 Unit, Bulk
 74 mm x 35 mm x 13 mm



03763 Snap armband „Mini“

Clever promotion slap bracelet. Available in 10 different colours. Universally usable.

Piece(s)	100	500	1000	5000
EUR	6.28	2.19	1.82	1.69

Plastic/PVC 1800 Unit, Bulk
 220 mm x 22 mm x 2 mm

03761 Snap armband „XXL“

Piece(s)	100	500	1000	5000
EUR	7.44	3.59	3.12	2.99

03762 Snap armband „Maxi“

Piece(s)	100	500	1000	5000
EUR	6.92	3.09	2.65	2.43

03764 Snap armband „Midi“

Piece(s)	100	500	1000	5000
EUR	6.79	2.92	2.43	2.30

03762
 310 mm x 31 mm x 2 mm
 1000 Unit, Bulk

03764
 250 mm x 31 mm x 2 mm
 1000 Unit, Bulk



04255 Auto sunshade „Screen“

Indispensable in summer. The solid carton unfolds easily for standing on the dashboard. Protects the interior of the vehicle against the sun. Custom designs possible as of 3,000 units.

Price on request

Paper/Cardboard
 1290 mm x 494 mm x 2 mm

45 Unit, Bulk



06745 Shade set „Umbra“

2-part shade set with suction cup. Foldable and easy to attach.

Piece(s)	1	100	500	1000
EUR	1.85	1.66	1.40	1.30

Textile/Nylon
 440 mm x 360 mm x 5 mm

200 Unit, Polybag



06747 Shade set „Nations“

Well-protected at all times with this shade for your car. German colours. 2-piece set. Incl. 2 suction cups each for mounting on windscreen.

Piece(s)	1	100	500	1000
EUR	2.39	2.15	1.80	1.69

Textile/Nylon
 380 mm x 445 mm

200 Unit, Polybag
 Fan items



SALE!



07619 Rain cape „Bowl“

Always ready to hand and well stowed. Lighter, transparent rain poncho made from PE plastic in a screw off plastic ball with spring hooks.

Piece(s)	1	500	1000	5000
EUR	1.37	1.23	1.03	0.96

Plastic/Polyethylene
Ø 63 mm

200 Unit, Polybag



07581 Rain cape „Open-Air“

Lightweight. Really low weight, reusable, single size. Practical for emergencies, sports events or travelling. Can be worn over normal clothing.

Piece(s)	1	500	1000	5000
EUR	1.05	0.94	0.79	0.74

Plastic/Polyethylene
1000 mm x 1200 mm

200 Unit, Polybag



01419 Rain poncho „Rainy“

An exceptionally lightweight and practical rain poncho. 100% recyclable, biodegradable, and reusable. Practical for emergencies, sporting events, and travelling. Can be worn over normal clothing. Size: one size fits all.

Piece(s)	1	500	1000	5000
EUR	1.63	1.46	1.23	1.14

Plastic/Polylactic acid
1300 mm x 1000 mm

200 Unit, Polybag
Fan items

SALE!



01449 Disposable Cover „Standard“

Lightweight disposable cover with hood in various different colours. Whether you wear it at a festival, sports event, or during unexpected showers while you're out and about - this cover will keep you nice and dry. Size: one size fits all.

Piece(s)	1	500	1000	5000
EUR	0.64	0.57	0.49	0.46

Plastic/Polyethylene
1270 mm x 1020 mm

200 Unit, Polybag



08803 Umbrella „Chavo“

Elegant umbrella with bars/rods made from glass fibre and metal as well as polyester cover. The ends of the umbrella are secured by plastic protective caps. The plastic handle guarantees pleasant carrying. Above the handle, there is a push button for opening the umbrella automatically. Including hook-and-loop fastener for closing the umbrella.

Piece(s)	100	500	1000
EUR	5.92	5.68	5.41

 Textile/Polyester
 870 mm x Ø 940 mm



 36 Unit, Polybag



08859 Cushion seat „Ease“

Practical for when you're on the move. The upper side of the cushion is made from 210 D Polyester and the underside is coated with aluminium insulating foil that protects against cold and damp. Via the small folded seams and space-saving nature, the mesh bag is kept closed with a drawstring. The logo imprint can be displayed directly on the cushion or the mesh bag.

Piece(s)	1	100	500	1000
EUR	4.01	3.59	3.02	2.82

 Textile/Polyester 210D
 320 mm x 320 mm x 5 mm



 100 Unit, Polybag



06186 Head rest, inflatable

Ideal for travelling. Made of skin-friendly material with velvety surface. Supplied in protective sheath.

Piece(s)	1	100	500	1000
EUR	2.55	2.28	1.93	1.80

 Plastic/PVC
 350 mm x 240 mm x 95 mm

 100 Unit, Polybag

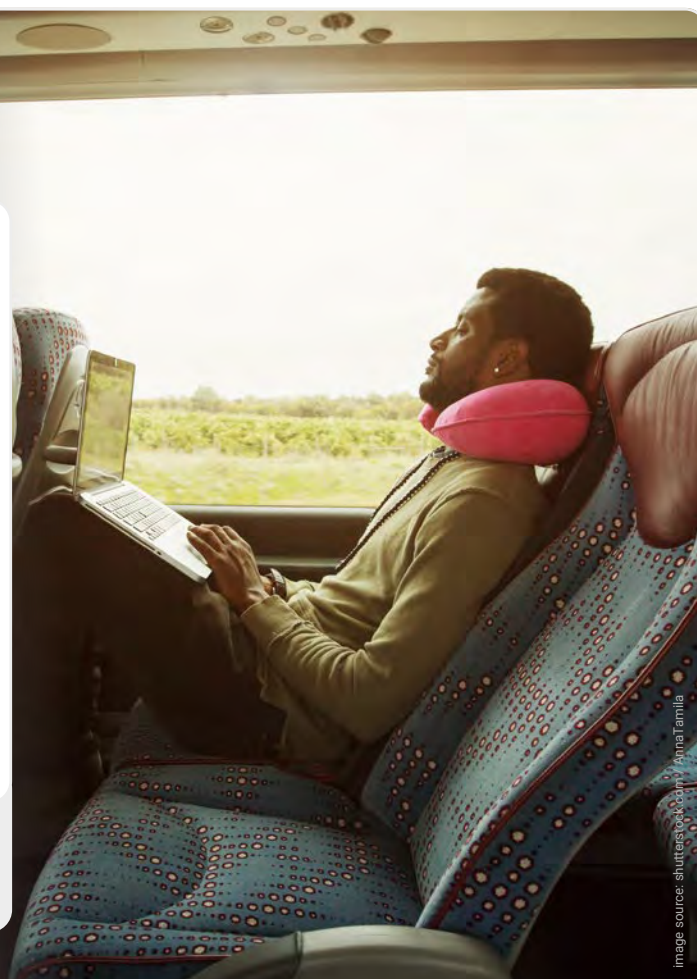

Image source: shutterstock.com / Anna Tamila



04079 Car Organizer „Classic“

For the tidy-minded. A handy car organizer for less chaos in your car. Made of PP the item fits perfectly in all common cup holders and offers sufficient space for the bits and pieces which should always be at hand. Ideal for storing your smart-phone, pens, notebooks and much more.

Piece(s)	1	500	1000	5000	
EUR	0.77	0.69	0.58	0.54	

Plastic/Polypropylene 200 Unit, Bulk
 92 mm x 136 mm



01237 Wastepaper bin „Tiny“

No more chewing gum wrappers flying around! Small, practical waste bin made from PP for your car or desk. Fits in all standard cup holders. The lid has a spring device and can be moved.

Piece(s)	1	100	500	1000
EUR	2.52	2.26	1.90	1.77

Plastic/Polypropylene 100 Unit, Polybag
 165 mm x Ø 100 mm



05111 Travelbox „Basic“

Square plastic box with sophisticated click closure for opening with only one hand. Offers a large advertising area and a lot of space for individual filling.

Piece(s)	1	500	1000	5000
EUR	1.74	1.56	1.31	1.22

Plastic/Polypropylene 140 Unit, Bulk
 112 mm x 104 mm x 24 mm



08517 Travelbox „Kids“

Square, practical plastic box with click closure that can be easily opened with one hand. Filled with template „ABC“ (03710), pencil set (06292), puzzle game (04069) and various painting templates.

Piece(s)	1	100	500	1000
EUR	3.63	3.25	2.73	2.55

Plastic 140 Unit, Bulk
 110 mm x 103 mm x 24 mm Toys, 4+

NEW!



01833 Badge holder „Badge“

Practical badge holder with a variety of uses. The high-quality pull-out cord with retractor mechanism can be extended to approx. 80 cm and thus easily reaches any card reader. Thanks to the carabiner, the holder can be easily attached to belts, bags, backpacks or anywhere else. Perfect for fairs, events, festivals, celebrations, conferences, etc.

Price on request

Plastic/ABS
 55 mm x 35 mm

500 Unit, 50 pcs. in a polybag



06628 ID card holder „Hard Plastic“

Protects cards, ID cards and tickets at different events. Ideal for attaching to lanyards. Horizontal format.

Piece(s)	1	500	1000	5000
EUR	1.12	1.00	0.84	0.79

Plastic/SAN
 92 mm x 70 mm x 5 mm

500 Unit, Polybag



09533 ID card holder „ID“

Elegant. Holder with pull-back and clip for attaching IDs. Includes clamp for attaching to clothing.

Piece(s)	1	100	500	1000
EUR	2.72	2.52	2.30	2.15

Metal
 80 mm x 33 mm x 16 mm



500 Unit, Polybag



04080 Card sleeve „Plastic Card“

Case for cheque cards of any type. Perfect protection especially for cards with sensitive magnetic strips.

Piece(s)	1	500	1000	5000	
EUR	0.48	0.43	0.36	0.34	

 Plastic/Polypropylene
 89 mm x 57 mm x 4 mm

 700 Unit, Bulk

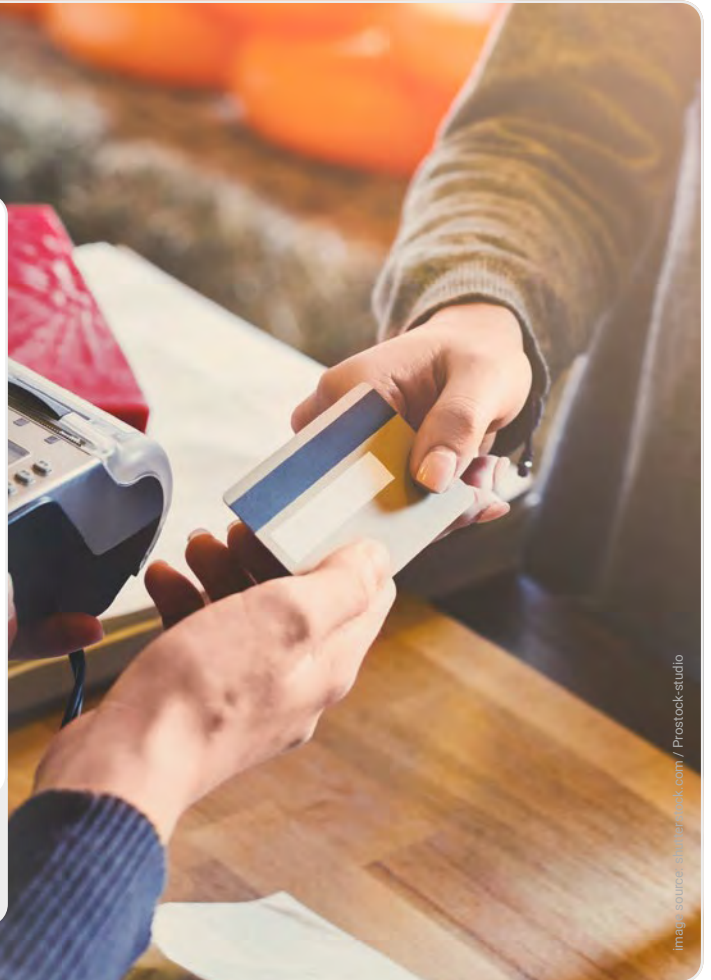

Image source: <https://www.gettyimages.com/> / Prostock-studio

Bags.

- *Carrier bags*
- *Cooler bags*
- *Backpacks*
- *Trolleys & Suitcases*
- *Sports Bags & Drybags*
- *Baskets*
- *Shoulder Bags*
- *Travel & Sports Bags*
- *Purses*
- *Bag & Suitcase Accessories*
- *Arm & fanny packs*
- *Toiletry bags & cosmetic bags*
- *Household bags*
- *Tablet & Notebook Bags*







09161 Folding box „Fresh“, small

Clever, foldable bag made from non-woven material with stable cardboard inlay on the sides as well as in the bottom and the lid. The bag is perfect for transporting delicate food products. It is very space-saving when folded - it is stable when unfolded. With 5.5 cm wide overflaps incl. hook-and-loop fastener for secure closure. The durable carrying handles with push button guarantee a pleasant feel without applying pressure to the hands.

Piece(s)	1	100	500	1000
EUR	7.31	6.54	5.51	5.14



 Plastic
 180 mm x 240 mm x 260 mm

 30 Unit, Polybag



09168 Cooling box „Fresh“, small

Piece(s)	1	50	250	500
EUR	9.12	8.16	6.88	6.42

 Plastic
 180 mm x 240 mm x 260 mm

 30 Unit, Polybag



08941 Cool Bag „Diamond“

Keep cool anywhere when travelling. Practical cool bag made of polyester with aluminium foil inside in stylish Diamond design. The bag has a zipper to store the purchases safely and to support the insulating effect. Folds into a handy case with zipper. Load capacity: 10kg

Piece(s)	1	100	500	1000
EUR	3.16	3.03	2.73	2.54

Textile/Polyester 210D 100 Unit, Bulk
 390 mm x 120 mm x 450 mm



07445 Cool bag „Non Woven“

Medium-sized non-woven bag with aluminium lining for transporting chilled goods. Includes zipper and handles. Film thickness: 2mm.

Piece(s)	1	100	500	1000
EUR	2.86	2.56	2.13	1.99

Textile/NonWoven 50 Unit, Bulk
 375 mm x 240 mm x 340 mm



07447 Cool bag „Picnic Cooler“

Practical cool bag made of non-woven and isolated with a 2 mm thick foam and aluminium foil. Zipper included.

Piece(s)	1	100	500	1000
EUR	2.33	2.07	1.76	1.63

Textile/NonWoven 150 Unit, Bulk
 300 mm x 410 mm x 100 mm



08448 Cooling basket „Thermo“

Useful basket featuring a light and stable aluminum frame, continuously sewn with non-tear polyester on the outside and insulating coating on the inside. The insulation is further supported by the all-round zip of the lid. Furthermore, the lid can be rolled up using the hook-and-loop fastener which facilitates filling and emptying the basket. The foldable handle is coated with soft EVA for comfortable carrying.



Piece(s)	1	25	100	250
EUR	21.43	19.18	16.16	15.08

Textile/Polyester 600D 10 Unit, Polybag
 480 mm x 275 mm x 230 mm

08887 Cool Bag „Paper“, small

The snack bag with a different style! Due to the aluminium foil inside the flexible cool bag looks like a classic paper bag, but keeps food cool for several hours. The bag is closed with two Velcro fasteners. The outer material is made of craft paper and can be written on again and again with pencil and erasable ink. Volume: 3,0 litres.



Piece(s)	1	100	500	1000
EUR	2.95	2.64	2.22	2.08

 Paper/Cardboard/Kraft paper  100 Unit, Bulk
 275 mm x 100 mm x 240 mm



08886 Cool Bag „Paper“, large

Piece(s)	1	100	500	1000
EUR	4.59	4.11	3.46	3.23



 Paper/Cardboard/Kraft paper  50 Unit, Bulk
 410 mm x 150 mm x 320 mm



08566 Cool bag „Paper“, big

A paper bag with surprise effect. The outside of the bag is made of kraft paper and features an additional pocket on the front. The main compartment is lined with a 2 mm thick insulating aluminium foil which allows transporting temperature-sensitive food. With practical handle and turnover cover with hook-and-loop fastener as well as piping in matching colours.

Piece(s)	1	100	500	1000
EUR	3.21	2.87	2.42	2.26



 Paper/Cardboard/Kraft paper  100 Unit, Polybag
 190 mm x 290 mm x 100 mm



01206 Backpack „Paper“, large

Not something you see every day! Natural backpack made from kraft paper with a durable polyester inner lining, adjustable straps and plenty of storage space for everything you need. It has a large main compartment, two side pockets and a front pocket with a zip. There is also a small pocket on the inside for valuables and for bits and bobs. The outer material is made of craft paper and can be written on again and again with pencil and erasable ink. Filling volume: approx. 14 litres. Load capacity: approx. 10 kg.

Piece(s)	1	100	500	1000
EUR	7.51	6.72	5.66	5.28

 Paper/Cardboard/Kraft paper  25 Unit, Polybag
 440 mm x 100 mm x 310 mm



06519 Bottle bag „Deluxe“

Light, folding bag with space for 6 bottles in separate compartments. The reinforced handle also ensures safe and pleasant carrying. Ideal for bottles (1,0 Litre) bought separately.

Piece(s)	1	100	500	1000
EUR	2.93	2.62	2.21	2.06

Textile/Polyester 600D 100 Unit, Bulk
 280 mm x 240 mm x 160 mm



06520 Bottle bag „Six 4 You“

With 2 handles and space for 6 bottles. The sewn-in bottle separator prevents broken bottles and noise when transporting glass bottles. Suitable for 1,5 L PET

Piece(s)	1	500	1000	5000
EUR	2.03	1.82	1.53	1.43

Textile/NonWoven 200 Unit, Bulk
 300 mm x 200 mm x 300 mm



07448 Bottle bag „Felt“

Very stable felt bag for carrying up to 6 bottles (max. 0.7 litres each). The partition walls between the individual compartments prevent the annoying clink of glass bottles and thus possible damage. The 3 mm thick felt, the wide handles and the polyester piping make this bag particularly robust. In case the bag is not used, it can be stored in a space-saving manner.

Piece(s)	1	100	500	1000
EUR	4.58	4.25	3.89	3.62

Textile/Polyester-felt 40 Unit, Polybag
 260 mm x 135 mm x 165 mm



SALE!

08689 Wine carry bag „Avignon“

Transporting and cooling at the same time. Carry bag made from transparent PVC for one bottle of white wine, sparkling wine or champagne. Can be filled with ice cubes for cooling the content. Can also be used as elegant gift bag.

Piece(s)	1	100	500	1000
EUR	2.27	2.04	1.72	1.60

Plastic/PVC 16P 120 Unit, Polybag
 470 mm x 110 mm x 110 mm



09469 Beach bag „Miami Beach“ small

Off to the beach. Great polyester bag with interior PVC coating, two handles made from thick cotton cords (15 mm in diameter) and metal eyelets at the holes for the handles. The white, sewn in small non woven pocket and the bag itself can be closed using the zip fastener incl. a zipper puller. Ample filling capacity thanks to the large bottom.

Piece(s)	1	100	500	1000
EUR	4.51	4.03	3.40	3.17

Textile/Polyester 300D 70 Unit, Polybag
 240 mm x 190 mm x 165 mm



09479 Beach bag „Miami Beach“ large

Piece(s)	1	50	250	500
EUR	11.27	10.09	8.50	7.93

09488 Beach bag „Miami Beach“ medium

Piece(s)	1	100	500	1000
EUR	7.42	6.64	5.59	5.22

09479
 650 mm x 450 mm x 90 mm
 30 Unit, Polybag

09488
 480 mm x 340 mm x 170 mm
 40 Unit, Polybag

SALE!

09290 Carry bag „Bolsa“ in portrait format

So much space! Useful non-woven-bag with large bottom and side fold and front pocket for extreme storage space. The all-over wave design guarantees a particularly high-quality look of the bag. The bag features a non-woven piping which prevents the material from fraying.

Piece(s)	1	500	1000	5000
EUR	0.96	0.86	0.73	0.67

Textile/NonWoven 100 Unit, Bulk
 330 mm x 200 mm x 380 mm



09291 Carry bag „Bolsa“ in horizontal format

Piece(s)	1	500	1000	5000
EUR	0.84	0.76	0.63	0.59

Textile/NonWoven 200 Unit, Bulk
 380 mm x 120 mm x 330 mm



01075 Cork backpack „Sughero“

A piece of nature on your back. The cotton backpack has a wide cork inlay on the bottom edge. As it is a natural product, there may be slight colour variations. The straps are adjustable.

Piece(s)	1	100	500	1000
EUR	4.31	3.86	3.25	3.03

Textile/Cotton 100 Unit, Bulk
 400 mm x 360 mm x 5 mm



01074 Cork bag „Sughero“

Always have a piece of nature with you. The tote bag with wide carry handles has a wide cork inlay on the bottom edge. As it is a natural product, there may be slight colour variations.

Piece(s)	1	100	500	1000
EUR	4.31	3.86	3.25	3.03

Wood/Cork 100 Unit, Bulk
 450 mm x 360 mm x 5 mm





01344 Drawstring bag „Step One“

Made from recycled PET! Hip gym bag with a quilted down look, made from recycled polyester. It is closed using two black cords.

Piece(s)	1	100	500	1000
EUR	7.35	6.58	5.54	5.17

Textile/Polyester
 380 mm x 420 mm

50 Unit, Polybag

01346 Shopping bag „Step One“

Made from recycled PET! Hip shopping bag with a quilted down look, made from recycled polyester. With convenient carry handles, zip fastener at the top and sewn-in zipped case inside.

Piece(s)	1	50	250	500
EUR	9.70	8.68	7.31	6.82

Textile/Polyester
 370 mm x 420 mm

50 Unit, Polybag



06551 Shopping bag „Pocket“

Folding polyester bag in small polyester case with stud fastener. Includes hook for keyring or for attaching to the bag.

Piece(s)	1	100	500	1000
EUR	2.98	2.67	2.25	2.10

Textile/Polyester 190T 400 Unit, Polybag
 520 mm x 470 mm x 4 mm



SALE!

08940 Shopping Bag „Tiny“

Foldable polyester shopping bag with a long handle for added comfort. The polyester case is sewn to the upper edge of the bag and therefore it cannot get lost. Load capacity: 10 kg.

Piece(s)	1	500	1000	5000
EUR	1.47	1.32	1.11	1.04

Textile/Polyester 210D 100 Unit, Bulk
 440 mm x 390 mm



SALE!

01361 Backpack „Pouch“

Made from 100% recycled material! Small, compact and extremely lightweight. Rucksack with adjustable straps, which can be folded into a case. Filling volume: approx. 13.5 litres. Loading capacity: max. 10 kg.

Piece(s)	1	100	500	1000
EUR	3.23	2.89	2.45	2.27

Textile/100% Polyester 80 Unit, Bulk
 300 mm x 125 mm x 430 mm



07659 Sports bag „Shirt“ Germany

Not just for sporty kids. Sports bag in the shape of a shirt with cord pull-tie. Can be worn as a rucksack or shoulder bag.

Piece(s)	1	100	500	1000
EUR	2.37	2.12	1.79	1.67

Textile/Nylon 200 Unit, Polybag
 400 mm x 460 mm x 5 mm



06640 Gym bag „Reflector“

Sports bag made of reflecting material and additional reflector stripes. With practical cord, can be worn as a rucksack or shoulder bag. Ideal for schoolchildren.

Piece(s)	1	100	500	1000
EUR	2.10	1.88	1.59	1.48

Textile/Polyester 190T 100 Unit, Bulk
 320 mm x 400 mm x 6 mm



09355 Gym bag „Cool“

Stylish and useful, all in one item. This clever cooling bag in the design of gym bag convinces with its inside aluminium foil. In combination with the 3 mm thick foam, it guarantees prolonged cooling of your beverages and meals. Easy to clean with a moist cloth.

Piece(s)	1	100	500	1000
EUR	2.31	2.06	1.74	1.62

Textile/Polyester 210D 50 Unit, Bulk
 400 mm x 330 mm x 5 mm



09448 Gym bag „Hipster“

Trendy gym bag made from non-woven material in beautiful wave design. The drawcord and the strong cords guarantee a secure closure of the bag. Usable as rucksack or shoulder bag.

Piece(s)	1	500	1000	5000
EUR	1.17	1.05	0.89	0.83

Textile/NonWoven 300 Unit, Bulk
 335 mm x 410 mm



09840 Sports bag „Rucksack“

Sports bag with replacable name tag, cord and reinforced corners that prevent tearing. Can be worn as a rucksack or shoulder bag.

Piece(s)	1	500	1000	5000
EUR	1.50	1.34	1.13	1.05

Textile/Polyester 210T 100 Unit, Polybag
 400 mm x 300 mm



08367 Shopping basket „Chapeau“

Keeps everything inside. Great, stable shopping basket with aluminium frame and polyester covering, incl. zipper compartment on the outside and rigid bottom. Two nets can be attached to the two foldable handles using Hook and loop fasteners. The nets are attached via zippers at the basket itself. Useful and at the same time flexible.

Piece(s)	1	25	100	250
EUR	14.64	13.56	12.48	11.64

Textile/Polyester 600D 6 Unit, Polybag
 455 mm x 265 mm x 245 mm



08402 Shopping basket „Silandre“

A round affair. Sturdy shopping basket with round aluminum frame, completely seamed with robust polyester. The foldable handle is coated with soft EVA for comfortable carrying.

Piece(s)	1	50	250	500
EUR	19.67	17.61	13.84	13.38

Textile/Polyester 600D 10 Unit, Polybag
 485 mm x 410 mm x 30 mm x
 Ø 400 mm



08451 Shopping basket „Vigo“

In this way, shopping is fun. Spacious, rectangular shopping basket featuring a light and stable aluminum frame, continuously sewn with double-layered polyester. The foldable handle is coated with soft EVA for comfortable carrying.

Piece(s)	1	50	250	500
EUR	17.08	15.28	12.88	12.02



Textile/Polyester 600D 10 Unit, 10 pcs. In a polybag
 455 mm x 265 mm x 230 mm



01087 Fruit and vegetable bag „ECOCARE“, small

Re-usable synthetic bag to replace plastic bags! This small Polyester bag with drawstring is perfect for taking with you for shopping and for carrying fruit and vegetables. Washable at 30°C. Load capacity: max. 2 kg.

Piece(s)	1	500	1000	5000
EUR	0.91	0.82	0.69	0.64

 Textile/100% Polyester
 250 mm x 230 mm x 3 mm



 400 Unit, Bulk



01086 Fruit and vegetable bag „ECOCARE“, large

Piece(s)	1	500	1000	5000
EUR	1.16	1.04	0.88	0.82

01085 Fruit and vegetable bag „ECOCARE“, medium

Piece(s)	1	500	1000	5000
EUR	0.96	0.86	0.72	0.68

01086
 400 mm x 300 mm x 3 mm
 400 Unit, Bulk

01085
 350 mm x 260 mm x 3 mm
 400 Unit, Bulk



01128 Fruit and vegetable bag „ECOCARE“, material mix, medium

The clever alternative to single-use plastic bags in the supermarket. One side of the large bag is made from 100 % cotton, the other from PET. The bag closes with a practical drawstring. Perfect for transporting fruit and vegetables. Load capacity max. 3 kg.

Piece(s)	1	500	1000	5000
EUR	1.70	1.52	1.28	1.19

Textile/Cotton
 300 mm x 250 mm x 3 mm

400 Unit, Bulk



01127 Fruit and vegetable bag „ECOCARE“, material mix, large

Piece(s)	1	100	500	1000
EUR	1.97	1.76	1.48	1.38

Textile/50% Cotton 50%Polyster 400 Unit, Bulk

400 mm x 350 mm x 3 mm

01194 Cotton fruit and vegetable bag „ECOCARE“, small

Environmentally friendly and sustainable. The reusable bag with drawstring is made from 100% cotton and is the alternative to the single-use plastic bag in the super market. Always hygienic, as it can be washed at 60°C. Load capacity: max. 3 kg.

Piece(s)	1	100	500	1000
EUR	2.21	1.98	1.67	1.55

Textile/Cotton
 325 mm x 235 mm

500 Unit, Bulk



01193 Cotton fruit and vegetable bag „ECOCARE“, large

Piece(s)	1	100	500	1000
EUR	3.00	2.69	2.26	2.11

Textile/Cotton 500 Unit, Bulk
 400 mm x 345 mm x 3 mm





SALE!

01088 Fruit and vegetable bag „ECOCARE“ with handles

An environmentally friendly alternative to plastic bags! This lightweight Polyester bag is perfect for taking with you for shopping and for carrying fruit and vegetables. Fitted with two handles to make light work of carrying heavy food items. Washable at 30°C. Load capacity: max. 8 kg.

Piece(s)	1	500	1000	5000
EUR	1.34	1.20	1.02	0.94



 Textile/100% Polyester  200 Unit, Bulk
 580 mm x 370 mm x 200 mm



01416 Fruit and vegetable bag „ECOCARE“ with textile insert, medium

This lightweight polyester bag with smooth 5 cm textile insert (single-sided) underneath and drawstring is perfect for taking with you for shopping and for carrying fruit and vegetables. Washable at 30°C. Load capacity: max. 3 kg.

Piece(s)	1	500	1000	5000
EUR	0.97	0.87	0.73	0.68



 Textile/Polyester  400 Unit, Bulk
 350 mm x 260 mm x 3 mm



01314 Fruit and vegetable bag cotton structure mix „ECOCARE“

The clever alternative to single-use plastic bags in the supermarket. One side of this large bag consists of 100 % cotton, the other is made from a cotton net material. It is closed using a practical drawstring. Perfect for transporting fruit and vegetables.

Piece(s)	1	500	1000	5000
EUR	2.01	1.80	1.51	1.41

 Textile/Cotton  200 Unit, Bulk
 300 mm x 400 mm



01030 Bread bag „ECOCARE“

THE alternative to plastic bags! Ecological cotton bag with drawstring for the environmentally friendly transport of bread, pastries and bread rolls. Load capacity max. 5 kg.

Piece(s)	1	100	500	1000
EUR	2.21	1.98	1.67	1.56

Textile/Cotton
 310 mm x 380 mm

300 Unit, Bulk



01199 Bag „Bionda“

Hip bag made from 100 % cotton. The high 400 g/m2 fabric weight and the round base allow the bag to stand up independently. Can be used open with the edge folded down, for example in the bathroom for the storage of hairbrushes, or in the kitchen as a bread bag. With a drawstring for easy closure. Load capacity: max. 3 kg.

Piece(s)	1	100	500	1000
EUR	2.81	2.51	2.12	1.98

Textile/Cotton
 325 mm x 315 mm x Ø 190 mm

200 Unit, Bulk



01540 Lunch bag „Cotton“, small

Compact, environmentally-friendly bag for snacks, to take with you to uni, work or school. The re-usable lunch bag fits into every pocket and is really easy to close thanks to the velcro fastening. Cotton certified according to Ökotex Standard 100. Washable at 60°C. As it is made from untreated cotton, the lunch wrap may shrink slightly with the first wash.

Piece(s)	1	500	1000	5000
EUR	1.59	1.42	1.20	1.12

Textile/Cotton
 180 mm x 180 mm

400 Unit, Bulk

01541 Lunch bag „Cotton“, large

Piece(s)	1	500	1000	5000
EUR	1.70	1.52	1.28	1.20

Textile/Cotton
 230 mm x 200 mm

400 Unit, Bulk



01542 Lunch wrap „Cotton“

Re-usable, compact substitute for aluminium made from certified cotton, for wrapping sandwiches or other snacks to take to uni, work or school. After use, the lunch wraps fold up small so that they fit neatly into any rucksack, unlike bulky lunch boxes. The re-usable bread paper can be used for snacks of any size. Thanks to the velcro fastening, snacks can be wrapped up easily and reliably. Cotton certified according to Ökotex Standard 100. Washable at 60°C. As it is made from untreated cotton, the lunch wrap may shrink slightly with the first wash.

Piece(s)	1	500	1000	5000
EUR	1.50	1.35	1.14	1.06

Textile/Cotton
 200 mm x 150 mm

320 Unit, Bulk



01236 Laundry net „PEARL“, small

Protect your laundry. The small laundry net is ideal for delicate blouses, stockings, bras, underwear and baby clothes. Thanks to the breathable, hard-wearing mesh, the net can be reused frequently and will protect your clothes for a long time. Incl. zip with plastic zip pull.

Piece(s)	1	500	1000	5000
EUR	1.43	1.28	1.08	1.01

Textile/100% Polyester
 400 mm x 250 mm

500 Unit, Bulk

01234 Laundry net „PEARL“, large

Piece(s)	1	100	500	1000
EUR	2.19	1.96	1.65	1.54

Textile/100% Polyester
 700 mm x 500 mm

250 Unit, Bulk



image source: shutterstock.com / didecs

NEW!



01770 Laundry bag „Jumbo“

Practical laundry bag for cleaning home and pet textiles. It is quick drying and made of recycled, dense twill fabric that allows water and soap to pass through. This allows the contents to be cleaned gently. Thanks to the practical full-width zip, the laundry bag can be conveniently filled and easily hung up to dry or collect laundry.

Piece(s)	1	100	500	1000
EUR	7.00	6.27	5.28	4.93

Textile/RPET
 700 mm x 800 mm

80 Unit, RPET-polybag

SALE!





01024 Backpack „Style“

Stylish 2-colour backpack with plenty of storage space. Big main compartment with several inner compartments (2 compartments, 1 mesh compartment and 1 zipper compartment). Large front pocket with zipper. In the padded back there is also a compartment for valuable items such as a purse. The handles are variably adjustable.

Piece(s)	1	25	100	250
EUR	16.40	14.69	12.37	11.54

 Textile/Polyester 300D

 12 Unit, Polybag

 310 mm x 100 mm x 440 mm



08028 Backpack „Picnic Deluxe“

For 4 people. Fork, knife and spoon made of stainless steel with plastic handle, plates, wine glasses made of plastic. Paper napkins, 1 salt and pepper cruet, 1 bottle opener, 1 cheese knife, 1 wooden chopping board and a removable wine bottle with cooling function. Insulated with grey PEVA foil.

Piece(s)	1	25	50	100
EUR	49.13	43.54	36.69	34.23

Textile/Polyester 600D 4 Unit, Polybag
 300 mm x 150 mm x 470 mm

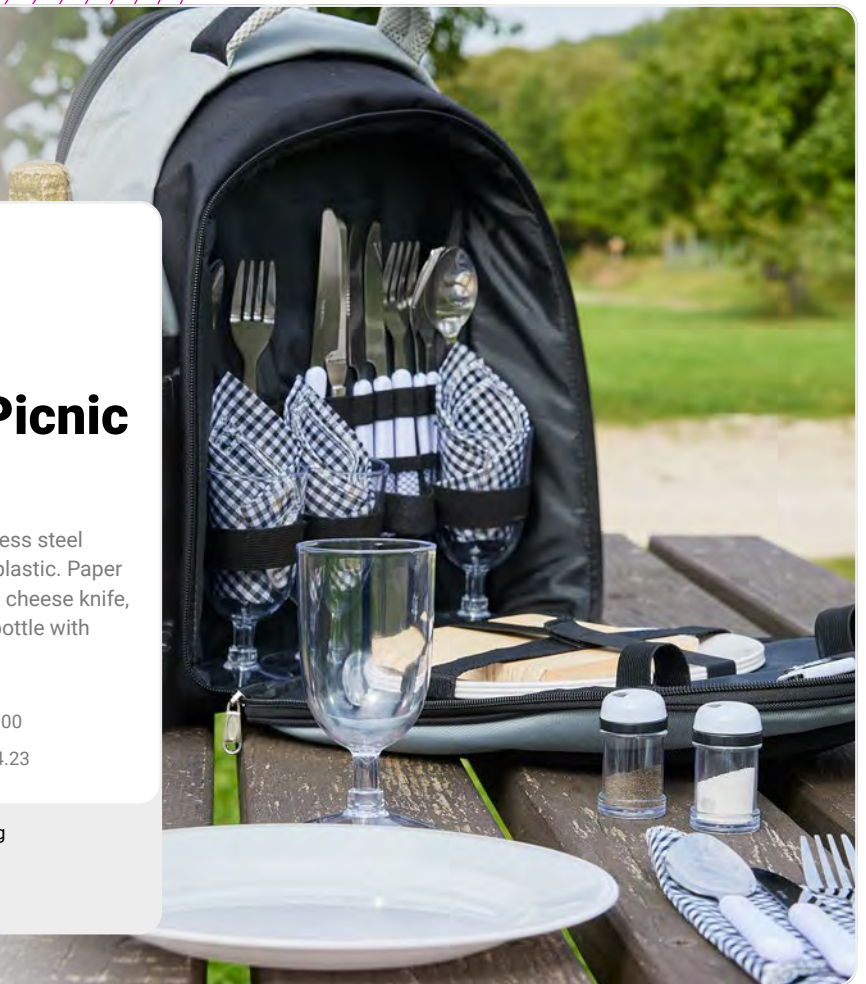

SALE!

01004 Backpack „Adventure“

Hip backpack for all adventures. Backpack with solid bottom, padded back, adjustable black carrying straps and a carrying handle. The main compartment can be securely closed with four magnets and hook and loop fastener. With polyester inner lining and inner compartment with zipper. Filling volume: approx. 10.0 litres.

Piece(s)	1	50	250	500
EUR	12.48	11.18	9.42	8.78

Textile/Canvas 30 Unit, Polybag
 490 mm x 270 mm x 100 mm



01035 Backpack „Piega“

Storage space to take with you. Spacious backpack, stowed folded up in sewn-on case. With two adjustable, padded straps, two open side pockets and case as additional compartment. Main compartment with zipper and two sliders. Load capacity max. 10kg, volume 30 litres.

Piece(s)	1	50	250	500
EUR	9.93	8.89	7.49	6.99

Textile/Polyester 300D 60 Unit, Bulk
 320 mm x 140 mm x 460 mm



09112 Backpack „Journey“

Modern backpack in a chic grey/black colour mixture. The backpack with padded back has an open front compartment and a mesh pocket on the side to store a water bottle. The PU badge sewn on the front makes it possible to attach shoes by threading the shoe laces through the badge and tying them together. The large inner compartment is closed with a black 2-way zipper. Capacity: approx. 15.0 litres

Piece(s)	1	50	250	500
EUR	8.30	7.69	7.07	6.60

Textile/Polyester 300D 25 Unit, Polybag
 280 mm x 140 mm x 400 mm



09111 Travel Bag „Journey“

Large travel bag in a chic grey/black colour mixture. The bag has a large main compartment and two short handles with padded handle protection. In addition, a long shoulder strap with a flexible shoulder pad can be easily attached using snap hooks. The bottom inlayer supports the stability of the bag. Utensils, which need to be quickly at hand, can be stowed in the front pocket with zipper. Capacity: approx. 55.0 litres

Piece(s)	1	25	100	250
EUR	14.80	13.70	12.61	11.76

Textile/Polyester 300D 20 Unit, Polybag
 580 mm x 270 mm x 380 mm



09114 Shopping Bag „Journey“

Nice shopping bag in a chic grey/black colour mixture. In addition to the main pocket, the bag has an open front pocket and a mesh pocket on the side, which is suitable for storing a water bottle. Capacity: approx. 13.0 litres

Piece(s)	1	100	500	1000
EUR	5.69	5.10	4.29	4.01

Textile/Polyester 300D 50 Unit, Polybag
 380 mm x 110 mm x 330 mm



09115 Bumbag „Journey“

Trendy fanny pack in a chic grey/black colour mixture. The fanny pack with stable, adjustable strap and generous zipper compartment can be carried around the waist as well as over the shoulder. The stable click closure allows easy opening and a secure hold on the body. Capacity: 1.0 litres

Piece(s)	1	100	500	1000
EUR	3.22	2.89	2.43	2.27



Textile/Polyester 300D 100 Unit, Polybag
 200 mm x 60 mm x 100 mm



09110 Toiletry Bag „Journey“

High-quality toiletry bag in a chic grey/black colour mixture. The bag has a sturdy carrying handle, a plastic hook, a large main compartment with mesh window for all important utensils and two further mesh compartments with zips in the upper part, which are ideal for holding smaller items. The toiletry bag is closed with two hook-and-loop fastener. Capacity: approx. 3.0 litres

Piece(s)	1	100	500	1000
EUR	5.93	5.49	5.05	4.71

 Textile/Polyester 300D
  80 Unit, Polybag



 250 mm x 80 mm x 240 mm



08369 Toilet bag „Care“

Black toilet bag made from double-layer polyester with elegant honeycomb pattern. Equipped with a large main compartment, a mesh pocket equipped with a zipper and a suspension hook, as well as a front compartment with zipper. Including a large handle at the top and small side handle.

Piece(s)	1	100	500	1000
EUR	9.11	8.15	6.87	6.41

 Textile/Jacquard
  50 Unit, Polybag

 260 mm x 100 mm x 230 mm





SALE!



01007 Jacket holder „Carry“

Free hands, space in your backpack and your jacket is still safely stored? This is possible with the new jacket holder „Carry“ Secure your jacket with this practical, anti-slip coated jacket holder. With the carabiner, the holder can be securely attached to the backpack with just one movement. Available in black and grey color.

Piece(s)	1	100	500	1000
EUR	2.07	1.84	1.56	1.46

 Textile/Nylon  400 Unit, Polybag
 400 mm x 25 mm





SALE!

09535 Luggage tag „Carabiner“

Textile luggage tag with metal carabiner as fastener. Rubber field for entering name, address and phone number. Custom colours as of 5,000 units.

Piece(s)	1	500	1000	5000
EUR	1.24	1.12	0.94	0.89



 Textile/Nylon  1000 Unit, Polybag
 180 mm x 40 mm x 3 mm



06107 Carrier „Travel“

Openable luggage tag in the shape of a suitcase with pre-printed insert inside. Only the name is clearly visible through the viewing window when closed. Incl. transparent PVC strap for easy attachment to travel bags and suitcases.

Piece(s)	1	500	1000	5000
EUR	0.39	0.35	0.29	0.27



 Plastic/ABS  500 Unit, Polybag
 97 mm x 56 mm x 4 mm



08283 Bag scales „Lift Up“

No more surprises when you check in. Light plastic scales for easy and practical checking of luggage weight (up to max. 40 kg). Ideal for travelling thanks to low weight and easy handling. With digital display.

Piece(s)	1	50	250	500
EUR	13.53	12.07	10.37	9.67

 Plastic/ABS
 122 mm x 90 mm x 25 mm



 40 Unit, Individual carton + Blister



01079 Felt basket „Mika“, large

Perfect for organising, reducing clutter and ideal for bathroom products, bits and bobs, media and office supplies and much more. Large, folding felt basket in the colour anthracite, with piping on the top edge. Includes base insert for even greater stability.

Piece(s)	1	100	500	1000
EUR	4.88	4.45	3.94	3.67

 Textile/Polyester-felt
 360 mm x 140 mm x 250 mm



 24 Unit, Polybag



06518 Wallet „Cash“

Large, rectangular bag made of synthetic leather with zip fastener. Ideal for storing and transporting cash.

Piece(s)	1	100	500	1000
EUR	2.01	1.80	1.52	1.41

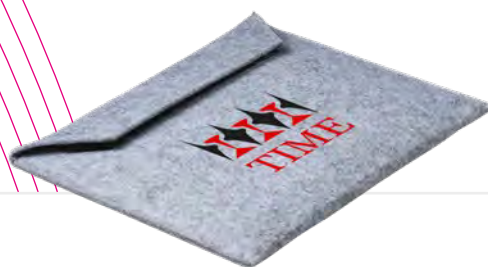

 Leather/Imitation leather  200 Unit, Polybag
 176 mm x 250 mm x 4 mm



06992 Tablet PC Sleeve „Felt“, 9.7“ maximum display size

Sleeve for a tablet PC with a maximum display diagonal of 24,6 cm (9,7“). The opening on the long side of the sleeve can be closed with velcro.

Piece(s)	1	100	500	1000
EUR	2.50	2.24	1.88	1.76



 Textile/Polyester-felt  200 Unit, Polybag
 265 mm x 215 mm x 7 mm



09497 Tablet PC sleeve „Cork“, 10.1“ maximum display size

A piece of nature, wrapped around technology. Tablet sleeve made of linen-colored textile, covered with cork. The sleeve can be used for tablet sizes up to 25,65cm (10.1“) and can be closed with a rubber strap held by a button.

Piece(s)	1	100	500	1000
EUR	4.30	3.85	3.24	3.03

 Wood/Cork  100 Unit, Polybag
 275 mm x 205 mm x 5 mm

Textiles.

- Blankets
- Towels
- Headwear





08066 Straw hat „Texas“

Once be a cowboy. Cool cowboy look straw hat with hook-and-loop fastener bandana for your advertising.

Piece(s)	1	100	500	1000
EUR	3.16	2.82	2.38	2.22

Straw 400 Unit, Bulk
 340 mm x 350 mm x Ø 355 mm



08380 Panama hat „Salvador“

South Sea style for the head. Great hat (paper) in classic cut, sewed with white nylon on the inside. Polyester strap with hook-and-loop fastener in black, white, red or blue.

Piece(s)	1	100	500	1000
EUR	5.06	4.53	3.82	3.56

Paper/Cardboard 180 Unit, Bulk
 280 mm x 240 mm x 120 mm



08641 Santa Christmas Hat

Funny Christmas cap made of mild felt.

Piece(s)	1	500	1000	5000
EUR	0.76	0.66	0.56	0.53

Textile/Polyester-felt 250 Unit, Polybag
 360 mm x 300 mm



08017 Traditional hat „Felt“ Bavaria

Fashionable grey felt hat with small asymmetric brim and white/blue band consisting of three individual cords. The hat is light and has a solid form.

Piece(s)	1	100	500	1000
EUR	3.65	3.27	2.75	2.57

Textile/Polyester-felt 48 Unit, Bulk
 275 mm x 230 mm x 120 mm Fan items



08601 Cap „Reflection“

With this cap you want to be seen. Great accessory made from polyester with reflective strips on the visor and on the sides, as well as reflective ventilation holes and a reflective button at the top. Hook and loop fastener opening at the back for size adjustment. Available in the colours white, neon yellow, neon orange and red.

Piece(s)	1	100	500	1000
EUR	2.68	2.40	2.02	1.89

Textile/Polyester
 180 mm x 220 mm

200 Unit, Bulk

08602 Cap „Reflection“ Kids

Piece(s)	1	100	500	1000
EUR	2.62	2.34	1.98	1.84

Textile/Polyester
 160 mm x 220 mm

200 Unit, Bulk

NEW!



01811 Bucket hat „Unicoloured“

Lightweight sun hat made of 100% cotton. The hat is foldable, universally usable and the perfect partner e.g. for travelling, sunbathing or fishing. Unisex size: Suitable for women, men and children.

Piece(s)	1	100	500	1000
EUR	1.89	1.69	1.42	1.33

Textile/Cotton
 Ø 570 mm

500 Unit, Polybag



04800 Sunshield „Style“

Ideal for beach and leisure. Plastic sunshield in bright trendy colours. Single sized.

Piece(s)	1	500	1000	5000
EUR	1.23	1.10	0.92	0.86

Plastic/Polystyrene
 230 mm x 185 mm x 47 mm

100 Unit, Bulk





NEW!





01815 Knitted hat „Fisherman“

Casual sailor cap for men and women. The classic roll cap completes the outfit at any time of the year and keeps the head warm on cold days. Whether as a fashion accessory in spring and summer or as a useful protector from cold, wet dirty weather, the cap always makes a good impression.

Piece(s)	1	100	500	1000
EUR	3.29	2.94	2.48	2.31

 Textile/Polyester

 215 mm

 200 Unit, Polybag



NEW!



01814 Knitted hat „Fisherman“

Casual, coarse knit sailor cap for men and women. The classic roll cap completes the outfit at any time of the year and keeps the head warm on cold days. Whether as a fashion accessory in spring and summer or as a useful protector from cold, wet dirty weather, the cap always makes a good impression.

Piece(s)	1	100	500	1000
EUR	3.32	2.97	2.50	2.34

 Textile/Polyester

 180 mm

 144 Unit, Polybag



01601 Multi-purpose scarf „Sporty“

Versatile scarf for a large range of uses. It can be worn as a face protector, collar, scarf, headscarf, wristband, pirate cap or balaclava. It's perfect to protect your neck and face against wind, dust and cold when cycling, angling, gardening, hiking, motorcycling, mountaineering, jogging or running.

Piece(s)	1	100	500	1000
EUR	1.84	1.64	1.39	1.30

Textile/95% Polyester 5% Spandex

200 Unit, Bulk
 Fan items

500 mm x 250 mm



01603 Multi-purpose scarf „Fleece“

Warm reversible scarf in fleece material, for a large range of uses. It can be worn as a face protector, collar, scarf, headscarf, wristband, pirate cap or balaclava. It's perfect to protect your neck and face against wind, dust and cold when cycling, angling, gardening, hiking, motorcycling, mountaineering, jogging or running. One end of the scarf has a drawstring to adjust the fit.

Piece(s)	1	100	500	1000
EUR	3.47	3.10	2.62	2.45

Textile/100% Polyester
 400 mm x 300 mm

100 Unit, Bulk



01198 Picnic blanket „Brighton“

Perfect for your next picnic! The lightweight blanket measures 180 x 180 cm, has a piped finish and is ideal for lengthy days out enjoying nature. Quick and simple to roll up, it can be stored in the bag tie bag provided without any problem.

Piece(s)	1	25	100	250
EUR	20.65	18.49	15.43	14.37

Textile/Polyester 210D
 1800 mm x 1800 mm

15 Unit, Polybag



09957 Fleece blanket „Polar“

Fluffy, soft and convenient for travel. Large (2 x 2 m) fleece blankets with H-strap as a carrying strap and double layered PU-Badge for advertising mounting and incl. small zip pocket.

Piece(s)	1	25	100	250
EUR	22.05	19.73	16.63	15.51

Textile/Polyester

2000 mm x 2000 mm x 10 mm

6 Unit, Polybag





01645 Fleece blanket „Basic“, 150x120 cm

Soft cosy blanket made of fleece material (180g/m²) with narrow merrow edging (overlock stitch). Easy care and hard wearing. Washable at 30° C, fast drying. Perfect for school, restaurants and cafés, hotel sector, also for events and your own sofa.

Piece(s)	1	50	100	250
EUR	5.23	5.11	4.79	4.65

 Textile/100% Polyester

 20 Unit, Bulk

 1500 mm x 1200 mm





01646 Fleece blanket „Supreme“, 150x120 cm

High-quality, soft cosy blanket made of thick fleece material (200g/m²) with narrow merrow edging (overlock stitch). Easy care and hard wearing. Washable at 30° C, fast drying. Perfect for school, restaurants and cafés, hotel sector, also for events and your own sofa.

Piece(s)	1	50	100	250
EUR	6.76	6.58	6.41	6.22

 Textile/Fleece

 15 Unit, Bulk



 150 mm x 120 mm



01625 Outdoor blanket „Relax“

The perfect blanket for everyone who loves being outdoors. Ultra-lightweight, water-repellent, and foldable, with a small drawstring pouch. The unique thing about this blanket are the metal eyelets in each of the four corners. Using the included plastic hooks, the blanket can easily be fastened to the ground. This makes picnics and breaks a breeze - even with windy weather.

Piece(s)	1	100	500	1000
EUR	8.58	7.68	6.47	6.04

 Textile/Polyester
 1500 mm x 2000 mm



 100 Unit, Polyester etui



01424 Apron „Deluxe“

Perfectly suited for all BBQ pros. Brown bbq apron in robust cotton with adjustable neck band and abdomen band. 2 pockets at front. The apron edges are enclosed with a polyurethane band.

Piece(s)	1	25	100	250
EUR	30.11	26.95	22.71	21.19

 Textile/Cotton
 860 mm x 640 mm

 35 Unit, Nonwoven Pouch

NEW!

01885 Apron „Gastro“, 90x58 cm

For all grilling and fire pros. High-quality black apron in cotton (180 gsm) with attached front pocket. Length of neck strap: approx. 60 cm. Length of side straps: approx. 82 cm.

Piece(s)	1	100	500	1000
EUR	4.75	4.25	3.58	3.34

Textile/Cotton 100 Unit, 10 pcs. In a polybag
 900 mm x 580 mm

NEW!

01884 Waist apron „Gastro“, 40x90 cm

For catering and home serving pros. High-quality black waist apron in cotton (180 gsm) with two attached front pockets. Length of side straps: approx. 85 cm each.

Piece(s)	1	100	500	1000
EUR	5.01	4.48	3.78	3.52

Textile/Cotton 100 Unit, Polybag
 400 mm x 900 mm



01065 Apron „Chef Griller“

Perfectly suited for all BBQ pros Black BBQ apron made from thick cotton (200 g/m²) with front pocket. Length of neck strap: approx. 60 cm. Length of side straps: approx. 88 cm.

Piece(s)	1	100	500	1000
EUR	5.92	5.30	4.47	4.17

Textile/Cotton 40 Unit, Polybag
 720 mm x 900 mm



01226 Microfibre cloth „Dusty“

Deep pile microfibre cloth with silky soft fibres for cleaning delicate objects. The cloth's soft fibres are particularly absorbent and don't leave any fluff or smears. Can be used on almost any surface indoors and outside. The deep-pile side is for cleaning, the other side is for polishing.

Piece(s)	1	100	500	1000
EUR	2.44	2.18	1.84	1.72

Textile/Microfibre 40 Unit, PVC box
 400 mm x 400 mm

Embroidered promotional textiles.



Quality
Made in
Germany.

Long-term advertising appeal.

Embroidered promotional items are perceived as high-class and of excellent quality. As such, they are more easily appreciated in everyday life. Long-term and continuous advertising effectiveness is achieved. Embroidery is one of the most high-quality and durable processes in the field of finishing, making embroidered textiles one of the most effective advertising items. Almost any kind of textile can be embroidered.

Special feel.

The process gives textiles an enduring and unique haptic that impresses even the greatest critic. Embellishing the promotional item with embroidery establishes a direct link to the consumer and the scattering effect is greatly reduced.



- ✓ Embroidery with up to 15 colours possible.
- ✓ Embroidery as a vibrant, high-quality method of finishing with advertising appeal.
- ✓ Suitable for almost any type of textiles.
- ✓ Lasts as long as the textile.
- ✓ Maximum embroidery size: 160 x 160 mm

Index.

Item	Item No.	Page	Item	Item No.	Page
Wastepaper bin „Tiny“	01237	296	Bento box „Narita“	09080	86
Storage box „Hold-all“ empty	05257	167	Cutlery set „Bamboo“	01417	109
Aluminium Bottle „Bamboo“, 0.6 l	01538	28	Cutlery set „To Go“	01036	109
Aluminium bottle „Miami“	01877	28	Cutlery set „Urban“	01103	109
Aluminium bottle „Sporty“ 0.6 l	09975	29	Cutlery bag „Tasca“	06111	126
Aluminium Bottle „Sporty“ 0.6 l matte	09992	29	Bag „Bionda“	01199	313
Aluminium Bottle „Sporty-2Tone“ gungrey 0.6 l	08871	29	Beeswax cloth „Beeologic“	01706	94
Aluminium bottle „2Tone“ 0.6 l, matte	08869	29	Beer mat stand „Beer crate“	04865	131
Ampule opener	04049	198	Beer coaster holder „Gastro“	01820	131
Apple splitter „Split ,n' eat“	06952	108	Beer coaster holder „Hill“	06089	131
Respiratory Mask „A“ FFP2 NR (Set of 10)	01481	212	Beer bottle crate „Six Pack“	07041	130
Respiratory Mask „AirCare“ FFP2 NR (Set of 10)	01764	212	Beer bottle carry-all „Take 6“	05005	131
Respiratory Mask „CareAir“ FFP2 NR (Set of 10)	01746	212	Beer crate seat „Woody“	08931	251
Respiratory Mask „CareOne“ FFP2 NR (Set of 10)	01769	212	Beer mug „Bavarian“ 0.25 l	09405	56
Respiratory Mask „Colour“ FFP2 NR, set of 10	01747	211	Beer mug „Bavarian“ 0.5 l	09403	56
Storage box „Swimming box“	04830	136	Eco-Coffee mug „Premium Deluxe“	11173	43
Storage box „Duo“	03663	198	Eco-Coffee mug „Premium“	14576	43
Storage box „Seven Days“	03664	198	Eco-Coffee mug „Premium“ small	14578	43
Inflatable crown „Germany“	08483	240	Eco-Coffee mug „PremiumPlus“	11063	43
Inflatable crown „Corona“	01209	260	Eco-Coffee mug „PremiumPlus“ small	11060	43
Eye mask „Oasis“	06180	201	Eco-Spoon	15646	110
Eye mask „Relax“	08246	201	Eco-Muesli Bowl „1-Colour“ matt finish	11164	60
Eye mask „Wellness“	06183	201	Eco-Muesli Bowl „2-Colour“ matt finish	15145	60
Badge holder „Badge“	01833	297	Eco-Muesli Bowl „Good Morning“	15135	61
ID card holder „ID“	09533	297	Eco-Shaker „Protein“	14456	58
ID card holder „Hard Plastic“	06628	297	Eco-Mug „Arica“	14898	47
Auto sunshade „Screen“	04255	293	Eco-Cup „Colour“ 0.4 l	15089	52
Car flag „Germany“	07787	237	Eco-Cup „Colour“ 0.5l	15088	52
Car flag „National flag - Germany“	07774	237	Eco-Lunchbox „Match“	14568	70
Car flag „Nations“	01244	237	Eco-Lunch box „School-Box“, large	15236	71
Avocado Peeler „Peel“	01015	109	Eco-Lunchbox „Switch“	15389	78
Pastry brush „Little Bakery“	04775	106	Eco-Flying Disc „Space Flyer 22“	11321	256
Baking Kit „Kids“	01546	107	Pencil „Black“	06259	147
Rubber duck „Squeeze“	06005	267	Pencil „Nature“ short	06287	146
Bumbag „Journey“	09115	318	Pencil „Nature“ long	06293	146
Beach ball set „Sun“	01726	259	Pencil „White“ with eraser	06271	147
Drinking cup „ToGo“ 0.3 l	01808	66	Pencil „Carpenter“	06282	146
Cup „Urban“	01098	85	Pencil sharpener „Helmet“	04291	153
Cup with attachment „Urban“	01089	85	Pencil sharpener „Trash Can“	04306	153
Cup with handle „Urban“	01097	85	Flower necklace „Bavaria“	07900	239
Bento box „Mitaka“	09081	86	Floral neck garland „Flor“	01080	239

Index.

Item	Item No.	Page	Item	Item No.	Page
Flower necklace „Hawaii“	08033	239	Glasses case „B-Box“	04810	175
Flower Necklace „Laola“	07798	239	Box „C-Box“	05134	136
Handcart „Crease“	08365	247	Box „First Aid“	05479	195
Hand cart „Wood“	01059	247	Box „Flat“	05478	136
Sweet dispenser	09051	122	Cigarette box „Zig-Box“	04072	177
Boston Shaker 0.7 l	09258	122	Kite „Diamond“	06099	259
Paper knife „Kombi“	04256	159	Drawstring bag „Step One“	01344	306
Paper knife „Multi“	04222	160	Rotating keyring „Heart“	04137	192
Safety Goggle Strap	01460	175	Rotating keyring „Point“ with chip	04120	192
Glasses pouch „Textile“	01462	175	Rotating keyring „Point“ without chip	04121	192
Bread bag „ECOCARE“	01030	313	Stainless steel cup „Metallo“	01347	49
Boomerang „Maxi“	01370	258	Shopping basket „Chapeau“	08367	309
Boomerang „Mini“	01368	258	Shopping basket „Silandre“	08402	309
Burger box „ToGo“	01744	66	Shopping basket „Vigo“	08451	309
Badge „Colour-Clip“	03792	180	Shopping Bag „Journey“	09114	318
Paper clip holder „Magnet Pyramid“	04438	166	Shopping bag „Pocket“	06551	307
COVID-19 Antigen Rapid Test, individual, lolly test	01886	215	Shopping Bag „Tiny“	08940	307
COVID-19 Antigen Rapid Test, Self-Test (Nose), Set	01889	215	Shopping cart chip „1 Euro“	04244	190
Camping chair „Safari“	01008	252	Shopping cart chip „Anti-Tick“	04249	190
Cap „Reflection“	08601	325	Shopping trolley token „Bamboo“	01699	189
Cap „Reflection“ Kids	08602	325	Shopping trolley token „Natural“	01037	189
Car Organizer „Classic“	04079	296	Shopping cart chip without hole	04243	190
Chip key pendant „Business“	09063	185	Shopping trolley token „Bamboo“	01720	189
Chip keyring „Elegance“	04128	192	Shopping Trolley Protection Kit	01461	181
Chip keyring „Fix“	04133	191	Ice scraper „All round“	04226	282
Chip keyring „Ghost“ with chip	04129	191	Ice scraper „Bi-Part“	06019	282
Chip-keyhanger „Rectangular“	04123	191	Ice scrape „Arch“	04310	279
Chip keyring „Square“	04127	191	Ice scraper „Crystal“ with glove	06004	282
Clip Chip	04078	190	Ice scrape „Delta“	04304	279
Cocktail stirrer „Oval“	05012	122	Ice scraper „Triangle“	04227	279
Cocktail stirrer „Round“	07893	122	Ice scraper „Easy“ with water scraper	04229	277
Cornhole Set „To Go“	01533	263	Ice scraper „Easy“ without water scraper	04228	277
Cutter knife „Carve“	06317	242	Ice scraper „Polar bear“	04236	280
Cutter knife „Corte“	01005	242	Ice scraper „Ice witch“	04303	277
Cutter knife „Grip“	06416	242	Ice scraper „Ergonomic“	04318	277
Cutter knife „Pro“	06318	242	Ice scraper „Grip“ with water scraper	04234	278
Lid „ToGo“	01822	66	Ice scraper „Grip“ without water scraper	04232	278
Plastic bauble „maxi heart“	05262	137	Ice scraper „Truck“	04235	281
Plastic bauble „mini heart“	05267	137	Ice scraper „Logo“	04231	279
Plastic bauble „mini ball“	05315	137	Ice scraper „Santa“	04239	280
Brain teaser „4 Wins“	03150	268	Ice scraper „Penguin“	04238	280

Index.

Item	Item No.	Page	Item	Item No.	Page
Ice scraper „Square“ with water scraper	04224	278	Felt hat „Seppel“	08077	240
Ice scraper „Square“ without water scraper	04223	278	Felt basket „Mika“, large	01079	321
Ice scraper „Square“	04225	279	Fitness box „Light“	09391	221
Ice scraper „Snowman“	04237	280	Fitness box „Medium“	09401	221
Ice scraper „Smartphone“ short scraping edge“	04320	281	Fitness box „Strong“	09402	221
Ice scraper „Smartphone“ long scraping edge	04321	281	Fitness towel „Cooling“	08932	226
Ice scraper „TopGrip - 3D Vision“	01012	276	Fitness towel „Keep Cool“	08378	226
Ice scraper „TopGrip - Clean Vision“	01011	276	Fitness towel „Sporty“ large	01043	226
Ice scraper „TopGrip - Digital Vision“	01013	276	Fitness towel „Sporty“ small	01044	226
Ice scraper „Trapeze“	05415	279	Fitness mat „Active“	01627	224
Ice scraper „Vision“ with glove	06003	282	Flag „Nations - Germany“ 1,5 m	07781	238
Ice scrape „Wave“	04305	281	Flag picker „Germany“	08688	133
Ice cube mould „Dolphins“	05027	112	Bottle holder „Bicycle“	05077	246
Ice cube mould „Hearts“	05029	112	Bottle holder „Flexi“	05121	247
Ice cube mould „Penguins“	05028	112	Bottle holder „Store“	05120	130
Ice cube mould „Squares“	05026	112	Ice bucket „Vince“	05254	113
Ice cube tray „Round“	05030	112	Bottle bag „Deluxe“	06519	303
Enamel cup „Cozy“, subli	01349	46	Bottle bag „Felt“	07448	303
Enamel mug „Cozy“, 160 ml, black	01831	46	Bottle bag „Six 4 You“	06520	303
Enamel mug „Cozy“, 160 ml, white	01832	46	Bottle cap „Close“	01023	130
Enamel cup „Cozy“, black	01348	46	Bottle cap „Kronkorken“	01732	129
Enamel cup „Cozy“, white	01351	46	Fleece blanket „Polar“	09957	327
Cutlery „Spork“	05294	110	Fleece blanket „Basic“, 150x120 cm	01645	328
Chopsticks, set of 2	01839	111	Fleece blanket „Supreme“, 150x120 cm	01646	328
Tiered cake stand „Slate“	01200	103	Mallet „Timber“	08596	105
Case „Felt“	06979	167	Fly swatter „Logo“	07123	141
Flag „Germany“, wooden pole	07777	238	Fly swatter „Kit“	05501	141
Bicycle flag „Wheel“ Germany	08630	237	Film magnet „Rectangle“	08541	164
Bicycle Saddle Cover „Velo“	09327	247	Leisure chair „Sunshine - Germany“	07590	252
Folding box „Fresh“, small	09161	300	Leisure chair „Sunshine“	07601	252
Pack of 11 paper fan straws „German flag“	01146	120	Fresh food cover „Universal“	01545	94
„Fan scarf „Germany““	08022	240	Football „Big Carbon“, large	01104	229
Fan keyring „Survival“	01145	187	Football „Mini Carbon“	01121	229
Fan makeup „Germany“	07270	240	Football „Champion“	01105	228
Fan make-up „Nations“ 2.0“	07409	240	Football „Classic“	01107	229
Fascial role „Flexibility“	01621	223	Football „Classico“, matte	01106	229
Pencil case „Cork“	09498	152	Football „Germany“, big	08086	230
Pencil case „Nino“	01203	167	Football „Germany“, small	08944	230
Grooming glove „Pet“	01050	142	Football „Goldstar“	01108	227
Felt pendant „Motiv“	06958	186	Football „League“	01109	228
Felt pendant „Strap“	06885	186	Football „Match“, large	01111	230

Index.

Item	Item No.	Page	Item	Item No.	Page
Football „Match“, small	01112	230	Glass bottle „Frosted“, 0.55 l	01562	24
Football net „All-Star“	07465	227	Glass bottle „Frosted“, 0.7 l	01563	24
Football goal „Pop Up“	07246	227	Glass bottle „Tea“	01082	27
Doormat „Home“, large	09310	139	Glass bottle with sleeve „Bamboo“ 0,55 l	01232	23
Doormat „Home“, small	09311	139	Glass bottle with sleeve „Bamboo“ 0,75 l	01521	23
Fan „Calor“	01081	176	Glass bottle „Bamboo“ 1,0 l	01027	23
Fan „Heart“	02320	176	Glass bottle „Flavour“ 0,5 l	01028	22
Fan „Cloud“	02310	176	Glass bottle with case „Iced“, 0.5 l	01369	25
Puzzle game „Duo Labyrinth“	03595	271	Glass bottle with case „Iced“, 1.0 l	01371	25
Puzzle game „Football“	04069	270	Glass bottle „Life“ 0,55 l	01025	22
Puzzle game „Midi round“	03508	271	Glass bottle „Life“ 0,7 l	01026	22
Puzzle game „Mini round“	03505	271	Glass bottle with sleeve „Ocean“ 0,36 l	01233	26
Puzzle game „Rectangle“	03515	271	Glass coffee cup „Cristallo“, large	01285	40
Puzzle game set „Traffic signs“	04074	270	Glass coffee cup „Cristallo“, small	01286	40
Gel heating pad „House“	06164	206	Glass carafe „Fresh“ 1,0 l	01029	27
Gel heating pad „Heart“	06162	206	Glass carafe „Minerale“, 0.85 l	01375	27
Gel heating pad „Oval“, large	06170	206	Barbecue „Braai“	07056	251
Gel heating pad „Oval“, small	06177	206	Barbecue brush	01869	250
Gel heating pad „Square“	06171	206	Barbecue mat „BBQ“, 2-piece set	01243	251
Gel heating pad „Rectangle“	06172	206	Grill scraper „BBQ“	01423	248
Gel heating pad „Round“	06187	207	Barbecue set „Party“	01871	250
Gel heating pad „Snowman“	06196	207	Grill barbecue tongs „Asado“	07482	250
Gel heating pad „Star“	06168	207	Grill barbecue tongs „BBQ“	01868	250
Gel heating pad „Hot-water bottle“	06173	207	Barbecue tong „Delano“	08665	248
Wallet „Cash“	06518	322	Grill barbecue tongs „Oak“	01872	249
Luggage tag „Carabiner“	09535	320	Barbecue tongs with bottle opener „Opener“, 35 cm	01718	249
Carrier „Travel“	06107	320	Grill tongs „Woody“	01796	248
Face visor „Protection“	01493	214	Exercise band „Bodywork“ light	09380	223
Spice Mill „Spice“	09467	104	Exercise band „Bodywork“ medium	09381	223
Glass container „Bamboo“, 375 ml	01550	93	Exercise band „Bodywork“ strong	09382	223
Glass container „Bamboo“, 700 ml	01551	93	Gymnastic band „Fitness“, light	01755	222
Glass container „Bamboo“, 1.6 l	01552	93	Gymnastic band „Fitness“, medium	01756	222
Glass box „Balance“ 17x12,6x5,5 cm	01357	91	Gymnastic band „Fitness“, strong	01757	222
Glass box „Balance“ 19,5x14,5x6 cm	01649	91	Exercise band „Resistance“, low resistance	01703	220
Glass box „Balance“, round 17x7 cm	01650	91	Exercise band „Resistance“, medium resistance	01704	220
Glass box „Balance“, round 19x7,5 cm	01651	91	Exercise band „Resistance“, high resistance	01705	220
Glass box „Cerrada“ 17x12.6x5.5 cm	01713	92	Gymnastics Band „Workout“, Set of 3	01628	222
Glass box „Cerrada“ 19.7x14.8x6 cm	01714	92	Hand disinfectant gel „Mano“, 100ml	01684	217
Glass box „Cerrada“ with 2 compartments 19.7x14.8x6 cm	01715	92	Hand disinfectant gel „Mano“, 50ml	01683	217
Glass bottle „Bamboo“, 0.65 l, colour	01791	23	Hand pump	06083	227
Glass bottle „Colare“, 0.60 l	01792	26	Hand gel „Bumper“	01468	218

Index.

Item	Item No.	Page	Item	Item No.	Page
Hand gel „Clean“ with carabiner	01467	218	Yo-Yo „Timber“	08755	265
Hand cleansing gel „Classic“, 100ml	01682	217	Yo-yo „Tricky Colour“	01150	264
Hand cleansing gel „Classic“, 50ml	01681	217	Yo-yo „Tricky“	01154	264
Mobile phone dock „PowerPort Holder“	03031	178	Coffee cup „Espresso“	01338	40
Mobile holder „Curved“	08633	179	Coffee mug „Florence“	01047	40
Barbeque tongs with bottle opener „Opener“, 43cm	01630	249	Coffee cup glass effect	01271	45
Wooden box „Pino“, small without dividing compart-	01532	137	Coffee cup glass effect with sleeve	01272	45
Token-keyring „Circle“	01643	189	Coffee mug „Medano“	08998	39
Token-keyring „Natural“	01038	189	Coffee mug „Premium Deluxe“	01173	42
Token-keyring „Round“	01642	189	Coffee mug „Premium Deluxe“ small	01177	42
Wooden magnet „Woody“	01634	164	Coffee mug „Premium“	04576	42
Wooden menu holder „Cube“	01631	132	Coffee mug „Premium“ Frozen	01215	43
Wooden sledge „Classic“	07973	231	Coffee mug „Premium“ Frozen small	01216	43
Wooden sledge „Snow“ large	08851	231	Coffee mug „Premium“ with cuff	04577	43
Wooden sledge „Snow“ small	08850	231	Coffee mug „Premium“ small	04578	42
Square wooden key ring „Maple“	01633	188	Coffee mug „Premium“ small, Paper	01548	44
Wooden key ring „Woody“	01632	188	Coffee mug „Premium“, Paper	01549	44
Dog bowl „Dog“	01068	142	Coffee mug „Premium“ small, upcycling	01716	41
Insulated Mug „Allan“	09906	36	Coffee mug „Premium“, upcycling	01717	41
Insulated mug „Coffee To Go“	05545	37	Coffee mug „PremiumPlus“	01063	42
Insulated Mug „Colombia“	09991	37	Coffee mug „PremiumPlus“ small	01060	42
Insulated mug „Gusto“	05547	37	Coffee cup „Roma“	01335	39
Insulating cup „Macchiato“	05987	36	Coffee mug „ToGo“, 0.3 l	01854	66
Insulated Mug „Melange“	06654	37	Coffee mug „Venice“	01048	39
Insulated mug „Mocha“	04827	38	Coffee cup „Vienna“	01284	39
Insulated cup „Mocha“ with tea strainer	01495	38	Bottle opener „Acrylic Colour“	04205	119
Insulated mug „Temptation“, large	01373	34	Bottle opener „Acrylic Transparent“	04207	119
Insulated mug „Temptation“, small	01372	34	Cap lifter „Arona“	08460	118
Insulated Bottle „Nevada“	09455	33	Bottle opener „Cap“	06891	115
Insulated bottle „Toronto“	09407	36	Cap lifter „Casoria“	09955	116
Thermos bottle „Vakuum“ 0.5 l	09885	33	Bottle opener „Classic“	01829	119
Thermos bottle „Vakuum“ 0.5 l, painted	09492	33	Bottle opener „Flat“	01500	117
Jacket holder „Carry“	01007	320	Bottle opener „Football“	01288	115
Yo-yo „Heart“	01117	264	Bottle opener „Globe“	01289	115
Yo-yo „Jeans“	01110	264	Bottle Opener „Nature“	08890	117
Yo-yo „Ball“	01140	264	Bottle opener „Police stop“	04029	115
Yo-yo „Light“	08753	265	Bottle opener „Push“	06407	114
Yo-yo „Maxi-Disc“	01114	265	Bottle opener „Push“ colour	01374	114
Yo-yo „Mini-Disc“	01113	265	Bottle opener „Salo“	01084	116
Yo-yo „Pro-Motion“	01120	264	Bottle opener „Screw“	01009	118
Yo-yo „Professional“	01135	265	Bottle opener „Speed“	07021	117

Index.

Item	Item No.	Page	Item	Item No.	Page
Bottle opener „Venecia“	06341	116	Cooling/heating pad „Round“	06188	208
Bottle opener „Woody“	06905	118	Cool/heat pad „Soft“, white	06193	208
Bottle opener with corkscrew „Corcho“	01006	116	Cooling pack „Freeze“	05423	113
Card sleeve „Plastic Card“	04080	298	Cool Bag „Paper“, large	08886	302
Cookie stamp „Candy Cane“	04421	106	Cool Bag „Paper“, small	08887	302
Cookie stamp „Snowflake“	04422	106	Cooling box „Fresh“, small	09168	300
Cookie stamp „Snowflake“	04420	106	Cooling pad „Active“, small	06277	208
Cookie stamp set „Cute“	04423	106	Cooling basket „Thermo“	08448	301
Children’s coloured pencil set „Eco Line“	04344	149	Cooling cuff „Cork“, small	09164	113
Children tooth mug „Care“	05288	200	Cooling cuff „Style“	09292	113
Folding knife „Lunchtime“	01238	108	Cool Bag „Diamond“	08941	301
Clothes hanger „Woody“	01204	138	Cool bag „Non Woven“	07445	301
Smallest Fitness studio	09389	222	Cool bag „Paper“, big	08566	302
Noisemaking hose „Sticks“	07740	234	Cool bag „Picnic Cooler“	07447	301
Noisemaking hose, self-inflating, „Germany“	08600	234	Kite „Volare“	05010	259
Cooking spoon „Madera“	01095	105	Beach chair „Chillout Deluxe“	08808	254
Bag scales „Lift Up“	08283	321	Beach chair „Chillout“	08494	254
Cork backpack „Sughero“	01075	305	Beach chair „Classy“	09278	253
Cork bag „Sughero“	01074	305	Beach chair „Harmony“	07602	253
Poo bag dispenser „Bone“	01333	143	Beach chair „Piccola“	08884	254
Dog Waste Dispenser „Dog“	08976	143	Beach chair „Recreo“	08885	253
Top „Classic wood“	02010	266	Ruler „16 cm“	03883	154
Top „Hurricane“	03431	266	Ruler „20 cm“	03884	154
Top „Stand-up large“	01178	266	Ruler „30 cm“	03885	154
Top „Stand-up small“	01175	266	Ruler „Metall“	09633	154
Top „Top“	01179	266	Ruler „Poly-S“	03715	154
Pen „Beech“	01866	150	Long drink glass „Crystal“, 0.3 l	01281	48
Ball pen „Novi“	09095	150	Lunch bag „Cotton“, large	01541	314
Pen „Shirakami“	01867	150	Lunch bag „Cotton“, small	01540	314
Pen „Touch Pen“	06379	150	Lunchbox „Elite“, small	01141	83
Ball pen „Yuma“	09094	151	Lunch box „Urban“	01100	84
Toilet bag „Care“	08369	319	Square lunch box „Urban“	01099	84
Toiletry Bag „Journey“	09110	319	Round lunch box „Urban“	01101	84
Plastic chip „40mm“	01678	180	Round lunch box with cutlery „Urban“	01102	84
Plastic knife „Bakery“	04897	108	Lunch wrap „Cotton“	01542	314
Cuddle cloth „Cuddle“	01017	267	Magnifying glass „Double 3 x/6 x“	04267	161
Kitchen timer „Falun“	01195	133	Magnifying glass „Fold 5 x“	04272	163
Cooling/heating pad „Bead“, oval	09198	207	Magnifying glass „Bookmark“	04218	160
Cooling/heating pad „Bead“, round	09197	207	Magnifying glass „Ruler 4 x“	04273	160
Cooling/heating pad „Fresh“, small	06179	208	Magnifying glass „Measurement 10 x“	04271	161
Cool/hot pad „Relieve“	06184	208	Magnifying glass „Slide“	04217	160

Index.

Item	Item No.	Page	Item	Item No.	Page
Spoon „Coffee portion“	05064	111	Miniature vehicle „Volvo Truck“	06103	274
Spoon „long handle“	05063	111	Miniature truck „Mercedes Actros MP4“	01124	273
Spoon „Plastic“	05646	110	Mint dispenser „Lightbulb“	04087	123
Spoon „Starter“	01841	111	Mint dispenser „Heart“	04090	123
Magnet „Area“	04003	164	Mint dispenser „Rectangle“	04086	123
Magnet „Triangle“	04009	164	Mint dispenser „Round“	04088	123
Magnet „Clapper board“	04307	164	Mint dispenser „Shirt“	04089	123
Magnet „Head“	04013	164	Mobile device holder „Upprett“	01431	179
Magnet „Crown cap“	04014	164	Motif puzzle „Einstein“	03020	268
Magnet „Magnifying glass“	04001	164	Mouse pad „Microfiber“	08964	168
Magnet „Oblong Maxi“	04002	165	Mousepad „Subli“	01137	168
Magnet „Oblong Mini“	04018	165	Multi-tool „Legend“	06349	244
Magnet „Square“	04011	165	Multifunctional box „Outdoor“	01873	251
Magnet „Square Maxi“	04006	165	Multi-purpose scarf „Fleece“	01603	327
Magnet „Square Mini“	04004	165	Multi-purpose scarf „Sporty“	01601	327
Magnet „Round“	04012	165	Multitool „Pocket“	09456	243
Magnetic Clip „Fridge“	08840	165	Multitool „Wood“, large	01132	244
Bucket hat „Unicoloured“	01811	325	Multitool „Wood“, small	01133	244
Crayon „Rainbow“ thin	06280	148	Cereal beaker „Spoon“	09593	59
Coloured pencil set „Jumbo“	06399	147	Cereal bowl „1 Colour“ matt finish	01164	60
Coloured pencil set „Nature 12“ long	06298	148	Cereal bowl „2 Colour“	05136	60
Coloured pencil set „Nature 6“ short	06292	148	Muesli Bowl „2-Colour“ Frozen	01218	60
Crayon set „Nature 6“ long	06297	148	Cereal bowl „2 Colour“ matt	05145	60
Crayon set „Skinny“	06398	147	Cereal bowl „Cereal“	01273	61
Mask fixture „Adjust“	01654	213	Cereal bowl „Good morning“	05135	61
Mask holder „Comfort“, large	01740	213	Knitted hat „Fisherman“	01815	326
Mask holder „Comfort“, medium	01492	213	Head rest, inflatable	06186	295
Massage device „Relaxation“	05224	202	First Aid Kit „Bag“, small	08513	196
Beer mug cover	04200	129	First Aid Kit „Box“, large	05073	195
Meal box „ToGo“ large	01743	65	First Aid Kit „Box“, small	05072	195
Meal box „ToGo“ medium	01724	65	Emergency kit „Emergency“	05117	194
Meal box „ToGo“ round	05109	68	First Aid Kit „Plaster Box“	05091	194
Menu card holder „Hill“	06090	132	First Aid Kit „Pouch“, large	01881	196
Menu card holder „Concrete“	01033	132	First Aid Kit „Pouch“, small	01880	196
Menu card holder „Gastro“	01821	132	Notebook „Agenda“ A4	07093	156
Microfibre cloth „Dusty“	01226	331	Notebook „Agenda“ A5	07092	156
Miniature vehicle „Delivery van“	05369	274	Notebook „Agenda“ A6	07091	156
Miniature vehicle „MAN Truck“	06714	274	Notebook „Cotton“ A4	06113	158
Miniature vehicle „Mercedes Truck“	06716	273	Notebook „Cotton“ A5	06114	158
Miniature vehicle „Mercedes Truck“ mini	06715	273	Notebook „Cotton“ A6	06115	158
Miniature vehicle „Coach“	06754	274	Notebook „Felt“	08092	157

Index.

Item	Item No.	Page	Item	Item No.	Page
Notebook „Cork“	09494	157	Pizza Slicer „Piece“	09358	108
Notebook „2Tone“	08950	157	Place mat „Felt“	08985	126
Notebook „Note“ A4	01002	156	Pastry cutter „Heart“	04118	107
Notebook „Note“ A5	01003	156	Pastry cutter „Moon“	04116	107
Notebook „Style“, A5	01039	157	Pastry cutter „Star“	04117	107
Rolling pin „Madera“, large	01092	105	Pastry cutter set „Sweet“	04119	107
Sewing set „Travel“	08568	139	Pastry cutter set „Sweet“ with box	04122	107
Fruit and vegetable bag „ECOCARE“, material mix, large	01127	311	Popcorn bowl „Hollywood“	04544	62
Fruit and vegetable bag „ECOCARE“, material mix,	01128	311	Popcorn bowl „Hollywood“, with stripes	04545	62
Fruit and vegetable bag „ECOCARE“ with handles	01088	312	Pussycat puzzle „Ball Pyramid“	03440	270
Fruit and vegetable bag „ECOCARE“, large	01086	310	Pussycat game „Catch the ball“	03488	270
Fruit and vegetable bag „ECOCARE“, medium	01085	310	Eraser „Pill“	04046	155
Fruit and vegetable bag „ECOCARE“, small	01087	310	Eraser „Square“	03312	155
Fruit and vegetable bag cotton structure mix „ECO-	01314	312	Eraser „Round“	03311	155
Cotton fruit and vegetable bag „ECOCARE“, large	01193	311	Rattle „Nations - Timber“	07320	235
Cotton fruit and vegetable bag „ECOCARE“, small	01194	311	Rattle „Whistle“	03633	235
Fruit and vegetable bag „ECOCARE“ with textile insert,	01416	312	Rattle „Supreme“ Germany	03651	235
Oven glove „Heat resistant“, set of 2	01656	134	Rattle „Timber“	09881	235
Organizer „Cork“	09495	152	Reflector „Traffic light“	03774	292
Outdoor blanket „Relax“	01625	329	Reflector „Car“	03779	290
Panama hat „Salvador“	08380	324	Reflector „Arch“	03798	290
Paper clip „Heart“	04216	167	Reflector „Bus“	03793	291
Pack of 100 paper straws „Nature“	01192	120	Reflector „Bear“	03776	291
Pack of 10 paper straws „Nature“	01191	120	Reflector „Dragon“	03787	291
Cardboard parking disk „Board“	05400	285	Reflector „Polar bear“	03800	291
Cardboard parking disk „Travel calculator“	05401	285	Reflector „Cyclist“	03782	292
Parking disk „Basic“	04245	283	Reflector „Ghost“	03789	291
Parking disc „Display Cleaner“	07629	283	Reflector „Lightbulb“	03784	290
Parking disk „Euro“ with chip	04253	285	Reflector „Heart“	03777	290
Parking disk „Euro“ without chip	04254	285	Reflector „Round“	03780	290
Parking disk „Prime“ with chip	04251	284	Reflector „Piggy“	03799	291
Parking disk „Prime“ without chip	04250	284	Reflector „Shirt“	03783	290
Parking disk „Professional“	04248	283	Rain cape „Bowl“	07619	294
Spatula „Madera“	01094	105	Rain cape „Open-Air“	07581	294
Whistle „Goal“	07415	236	Rain poncho „Rainy“	01419	294
Whistle „Reflector“	03634	236	Disposable Cover „Standard“	01449	294
Whistle „Keyring“	03635	236	Umbrella „Chavo“	08803	295
Plaster box „Cross“	05096	194	Director's chair „Star“	06110	253
Bandage box „Stripe“	05101	194	Tyre marker set „Car“	04242	287
Picnic blanket „Brighton“	01198	327	Tyre tread measuring device „Card“	04301	286
Pizza box „ToGo“	01834	67	Tyre tread measuring device „Chip“	04075	287

Index.

Item	Item No.	Page	Item	Item No.	Page
Tyre tread measuring device „Truck“	04311	286	Key ring „Natura“, heart	01291	188
Tyre tread measuring device „Profi“	04300	286	Key ring „Natura“, square	01290	188
Travel game „Peg game mini“	03030	268	Key ring „Natura“, oval	01292	188
Travel Bag „Journey“	09111	318	Key ring „Natura“, round	01293	188
Rubber band „Loop“ light	09383	221	Key pendant „Open“	09599	185
Rubber band „Loop“ medium	09384	221	Keyring „Parma“	06000	185
Rubber band „Loop“ strong	09385	221	Keyring „Police stop“	04035	184
Backpack „Adventure“	01004	317	Keyring „Rectangle“	01155	182-183
Backpack „Journey“	09112	318	Key fob „Tyre tread measuring device“	04302	286
Backpack „Paper“, large	01206	302	Keyring „Round“	01156	182
Backpack „Picnic Deluxe“	08028	317	Key fob „Safe contact“	01491	181
Backpack „Piega“	01035	317	Key fob „Safe contact“ with key ring	01499	181
Backpack „Pouch“	01361	307	Key fob „Tick map“	00630	197
Backpack „Style“	01024	316	Key ring „Folding ruler“	06315	246
Salt and Pepper Shaker „Flavour“	09463	104	Key pendant box „Anti-Tick“	04314	197
Salt and pepper set „Duo“	01297	104	Key pendant card „Anti-Tick“	04315	197
Salt and pepper set „Dispense“	01874	104	Key case „Nino“	01205	187
Sandwich box „ToGo“	07406	67	Sledge „Glide Midi“	01835	232
Bowl „Breakfast“	05046	62	Snow glider „Olymp“	01837	232
Shade set „Nations“	06747	293	Sledge „Standard“	01830	232
Shade set „Umbra“	06745	293	Chopping board „Acacia“	01239	98
Sliding puzzle „Frame 15“	03045	272	Chopping board „Bamboo“ large	08062	99
Sliding puzzle „Frame 16“	03463	272	Chopping board „Bamboo“ small	08361	99
Sliding puzzle „Frame 62“	03461	272	Chopping board „Bamboo“ medium	08360	99
Sliding puzzle „Space 14“	03464	273	Chopping board „Bamboo“, 24.5x17.5 cm	01818	100
Sliding puzzle „Space 15“	03462	272	Chopping board „Bamboo“, 32x30 cm	01819	100
Sledge „Toboggan“	07603	231	Chopping board „Bamboo“, rectangle, 24.5x17.5 cm	01816	100
Key pendant „Anti-Tick“	04316	197	Chopping board „Bamboo“, rectangle, 32x20 cm	01817	100
Key pendant „Apartment“	09061	184	Chopping board „Sandwich“	05228	98
Key fob „Cardiff“ oval	01196	186	Chopping board „Lunch“	05264	98
Key fob „Cardiff“ rectangular	01197	186	Chopping board „Natural“, bamboo	01547	99
Key fob „Care“	01016	184	Cutting board „Plus“	05286	97
Keyring „Angel“	01157	182	Chopping board „Snack“	05229	97
Key pendant „Pocket Bottle“	09574	184	Chopping board „Universal“	05284	98
Keyring „Heart“	01158	182	Cutting board „Woody“ heart	08743	101
Keyring „Inlay 35*24“	07945	183	Chopping board „Woody“ rectangular	06739	101
Key ring „Cork“, rectangular	01638	187	Cutting board „Woody“ square, large	08366	101
Key ring „Cork“, round	01639	187	Cutting board „Woody“ square, medium	08363	101
Keyring pendant „Letter Opener“	08983	185	Chopping board „Woody“ round	06740	101
Keyring „Magnifying glass clapper board“	04297	183	Cutting board „Woody“ wave	08362	101
Keyring „Mini clapper board“	04295	183	Chopping board „Woody“ with handle	06741	101

Index.

Item	Item No.	Page	Item	Item No.	Page
Message board „DIN A4 colour“	04435	159	Shaker „Protein“, Pro, 0.40 l, Version 2	01856	57
Message board „DIN A4 black“	04431	158	Shaker „Protein“, Pro, 0.40 l, Version 3	01857	57
Message board „DIN A5“	04428	159	Shopping bag „Step One“	01346	306
Shoe horn „Cliff“	05103	140	Filter insert for bottle „Cascada“	01719	30
Shoe horn „Grip“	05092	140	Sieve insert for insulated mug „Temptation“	01838	34
Shoe horn „Madera“, large	01091	140	Cushion seat „Ease“	08859	295
Shoe horn „Madera“, large with backscratcher	01096	140	Slidepads „Flow“, set of 2	01622	224
Shoe horn „Madera“, small	01090	140	Slippers „Frottee“	06650	141
Shoe horn „Tiny“	01882	141	Smartphone gloves „Touch“	06434	180
Shoe shining set „Fusion“	08289	139	Smartphone holder „Woody“	01629	179
Protective box „Toothbrush“	05407	199	Snack bowl „Imbiss“	01352	63
Safety goggles „Safety“	01430	214	Snack bowl „Imbiss“ with lid	01353	63
Sweatband „Nations - Germany“	07459	240	Snack cup „Snaxiko“	04543	62
Apron „Chef Griller“	01065	331	Snap armband „Maxi“	03762	292
Apron „Deluxe“	01424	330	Snap armband „Midi“	03764	292
Apron „Gastro“, 90x58 cm	01885	331	Snap armband „Mini“	03763	292
Food-Bowl „ToGo“, 1,0 l	01766	68	Snap armband „XXL“	03761	292
Food-Bowl „ToGo“, 2,2 l	01768	68	Sock collector „Laundry“	04436	138
Cereal box „Cereal“	04777	94	Softball „Midi 70“	01240	262
Pouring container „Storage“	01624	94	Softball „Mini 42“	01225	262
Soap Dispenser „Bamboo“, 0.2 l	01644	203	Mini-Softball	07514	261
Soap dispenser „Basic“ 0.4 l, colour	01674	205	Sunglasses „Bamboo“	07757	172
Soap dispenser „Basic“ 0.4 l, clear/transparent	01671	205	Sunglasses „Beach“, clean-up	01623	170
Soap dispenser „Basic“ 0.7 l, colour	01675	205	Sunglasses „Blues“	07878	172
Soap dispenser „Basic“ 0.7 l, clear/transparent	01672	205	Sunglasses „Blues“ ocean	08080	172
Soap dispenser „Basic“ 1.0 l, colour	01676	205	Sunglasses „Blues“ sun	08081	172
Soap dispenser „Basic“ 1.0 l, clear/transparent	01673	205	Sunglasses „Carbon“	01275	173
Soap dispenser „Deluxe“ 0.4 l, transparent	01659	204	Sunglasses „Sunshine“	01277	173
Soap dispenser „Deluxe“ 0.7 l, transparent	01660	204	Sunglasses „Vacation“	01278	174
Soap dispenser „Deluxe“ 1.0 l, transparent	01661	204	Sunglasses „Verano“	01279	174
Soap Dispenser „Pure“ 250 ml	01436	203	Sunshield „Style“	04800	325
Soap Dispenser „Pure“ 500 ml	01437	203	Savings box „Piggy“	03771	177
Serving plate „Slate“ rectangle	08792	103	Savings box „Self-Made“	03770	177
Serving platter „Slate“ XXL	01129	102	Savings box „Sweet Home“	06093	177
Serving plate „Slate“ medium	08553	102	Fun glasses „Bavaria“	07877	175
serving platter „Slate“ round, large	01130	103	Fun glasses „Germany“ with flower chain	08049	239
Shaker „Lagoon“ 0.5 l	05108	59	Football „Giant“	07439	261
Shaker „Multi“	05066	59	Football „Giant“, medium	01189	261
Shaker „Protein“ small	01045	57	Football „Giant“, small	01190	261
Shaker „Protein“	04456	57	Game box „Building blocks“ coloured	05502	267
Shaker „Protein“, Pro, 0.40 l, Version 1	01855	57	Coin Dish	03212	268

Index.

Item	Item No.	Page	Item	Item No.	Page
Sports bracelet „Viva“	01072	225	Tray „Profi 320“	05099	95
Gym bag „Cool“	09355	308	Tray round, medium	01219	96
Gym bag „Hipster“	09448	308	Tray „Service“	05042	96
Sports bag „Rucksack“	09840	308	Waist apron „Gastro“, 40x90 cm	01884	331
Sports bag „Shirt“ Germany	07659	307	Dog treat bag „Goodie“	01052	143
Spray bottle „Superior“, 0.4 litre, transparent	01665	204	Bag „Waterproof Smartphone“	06844	180
Spray bottle „Superior“, 0.7 litre, transparent	01666	204	Pocket knife „Pocket“ small	09789	243
Spray bottle „Superior“, 1.0 litre, transparent	01667	204	Pocket knife „Steel“ large	06328	243
Jumping ball „Basketball“ 2.0	06444	262	Penknife „Wood“	01131	243
Jumping ball „Football“, small	06202	262	Pocket mirror „Fold-Out“	07426	176
Skipping rope „Wood“	01452	225	Mug „Arica“	04898	47
Upright magnifying glass „Box“	04023	161	Cup „Mira“	01360	47
Upright magnifying glass „Jupiter 2“	04026	161	Cup „Mira“, Tritan	01524	47
Upright magnifying glass „Measurement 8 x“	04233	162	Cup „Nice Day“	08962	47
Upright magnifying glass „Micro“	04240	162	Tea Cup	04900	47
Magnifying glass with handle „Handle 3 x“	04278	162	Teapot „Tea-Time“	01497	27
Magnifying glass with handle „Handle 4 x“	04279	162	Dough scraper „Little Bakery“	04776	106
Magnifying glass with handle „Handle 5 x“	04277	162	Insulated mug „Diamond“	06108	35
Pen roll „Cork“	09496	152	Thermo-Mug „Milano“, 0,35 l	01535	36
Pencil holder „Basic“ large	06690	149	Insulated soup container „Take Away“	01287	63
Desk organiser „Clapper board“	04293	166	Cooling mat for animals „Chill“, large	01366	144
Coloured pencil set „Sharpener“	06408	149	Cooling mat for animals „Chill“, small	01367	144
Sweat band „Hairy“	07833	240	Animal travel blanket „Travel“	01051	142
Beach bag „Miami Beach“ large	09479	304	Table football „Goal“	07375	263
Beach bag „Miami Beach“ small	09469	304	Table football „Mini Soccer“	07620	263
Beach bag „Miami Beach“ medium	09488	304	Table tennis set „Robust“	01420	259
Knitted hat „Fisherman“	01814	326	Pot holder „Heat resistant“	01657	134
Straw „Glass“	01207	121	Traditional hat „Felt“ Bavaria	08017	324
Straw „Telescopic“	01208	121	Carry bag „Bolsa“ in portrait format	09290	304
Straw set „Paper“	01042	120	Carry bag „Bolsa“ in horizontal format	09291	304
Straw set „Steel“	01022	121	Travelbox „Basic“	05111	296
Straw hat „Texas“	08066	324	Travelbox „First Aid“	05115	195
Straw hat „Texas“ Germany	08067	240	Travelbox „Kids“	08517	296
Tablet PC Sleeve „Felt“, 9.7" maximum display size	06992	322	Whistle „Ref“	07234	236
Tablet PC sleeve „Cork“, 10.1" maximum display size	09497	322	Whistle „Sport“ with cord	03637	236
Tray „Beer crate“	05043	97	Whistle „Sport“ with cord, duo-colour	01364	236
Tray „Bistro“	05041	96	Whistle „Arena“	09317	236
Tray „Gastro-Expert 360“	05116	95	Drinking cup „Caipi“	05263	49
Tray „Gastro-Pro 360“	05069	95	Drinking cup „Colour“ 0.4 l	05089	51
Tray „Maxi-heart“	05049	96	Drinking cup „Colour“ 0.5 l	05088	51
Tray „Profi 240“	05040	95	Drinking glass „Crystal“, 0.04 l	01282	48

Index.

Item	Item No.	Page	Item	Item No.	Page
Drinking glass „Crystal“, 0.3 l	01283	48	Water bottle „Guard“ 0.5 l	09978	14
Drinking cup „Ergonomic“ 0.2 l	05098	50	Water bottle „Portland“	08930	17
Drinking cup glass effect	01274	49	Drinking bottle „Power Bottle“	05085	17
Beaker „Liquor“	05118	50	Drink bottle „School“ clear-transparent incl. strap, 1.0 l	01268	12
Drinking cup „Maxi Cup“ 0.4 l	05097	54	Drink bottle „Sports“ grey-transparent 0.4 l, RPET	01785	20-21
Drinking cup „Returnable“ 0.4 l	05083	53	Water bottle „Squeeze“	08928	17
Drinking cup „Deposit“ 0.4 l paintable	05125	53	Drink bottle Colare „Refresh“ clear-transparent, 1.0 l	01848	20-21
Drinking cup „Returnable“ 0.5 l	05082	53	Tube Pusher „Squeeze“	09070	135
Drinking cup „Midi Cup“ 0.3 l	05094	54	Gym bag „Reflector“	06640	308
Drinking cup „Mini Cup“ 0.2 l	05080	54	Door sign „Plaza“	01073	138
Drinking cup „Deposit“ 0.3 l	05086	53	Door sign „Woody“	01883	138
Drinking cup „Deposit“ 0.4 l	05081	53	Bag clip „Easy Fresh“	04430	135
Drinking cup „Deposit“ 0.5 l	05084	53	Universal box „Mini“	04084	136
Drinking beaker „promotion“	05119	51	Universal box „ToGo“	05200	69
Drinking cup „Rip“ 0.4 l	05074	50	Coaster „Card“	09314	128
Drinking cup „Take Away“ 0.3 l	05067	55	Coaster „Logan“	01182	129
Drinking cup „Take Away“ 0.4 l	05068	55	Coaster „Opener“	08756	128
Drinking cup „Take Away“ 0.5 l	05070	55	Coaster „Round“	09312	128
Drinking cup „Drink safe“	05065	50	Coaster „Slate“ round	08551	126
Cup „Tumble“	05133	49	Coaster „Slate“ square	08552	126
Drinking cup „Turin“	01053	55	Coaster „Tricot“	09313	128
Drinking cup „Turin“ with lid	01054	55	Coaster „Woody“ square	01212	127
Drinking cup set „Travel“	05050	51	Coaster „Woody“ round	01213	127
Water bottle „3in1“	09073	17	Coaster and lid „2 in 1“	05031	129
Water bottle „Acqua“ tritan	09952	14	VR glasses „Cardboard“	08693	178
Water bottle „Atlanta“	08953	16	VR glasses „Cyber“	08695	178
Water bottle „Austin“	08927	16	Vacuum flask „Bambus“, large	01294	32
Drink bottle „Cascada“, 0.67 l	01789	16	Vacuum flask „Bambus“, small	01295	32
Drink bottle „Cascada“, 0.87 l	01790	16	Vacuum flask „Cascada“, 0.35 l	01354	30
Drinking bottle „Champion“ 0.55 l	05059	19	Vacuum flask „Cascada“, 0.5 l	01356	30
Water bottle „Champion“ 0.7 l	05105	19	Vacuum flask „Colare“ 0.5 l	01707	31
Drink bottle „Denali“	01878	28	Vacuum flask „Colare“ 0.75 l	01708	31
Water bottle „Denver“ Tritan	08705	14	Vacuum flask „Colare“ 1.0 l	01709	31
Water bottle „Bicycle“ 0.5 l with drinking nipple	05076	18	Permit scraper	05406	287
Water bottle „Bicycle“ 0.5 l with cap	05075	18	Vignette scraper „Allround“	05411	287
Water bottle „Bicycle“ 0.7 l with drinking nipple	05078	18	Business card holder „Vita“	08746	159
Water bottle „Bicycle“ 0.7 l with cap	05079	18	Lunch box „Aluminium“	08456	87
Water bottle „Fitness“ 0.5 l with suction lock	05129	19	Lunch box „Aluminium“, large	01123	87
Water bottle „Fitness“ 0.7 l with suction lock	05131	19	Storage container „Apart“ 17x13x6 cm	01647	89
Fruit Infuser Bottle „Frutto“ 0,5 l, tritan	09493	15	Storage box „Apple box“	05037	82
Fruit Infuser Bottle „Frutto“ 0,8 l, tritan	09954	15	Lunch box „Arena“	05035	79

Index.

Item	Item No.	Page	Item	Item No.	Page
Lunch box „Bamboo“, large	01537	90	Lunch box „Twin Box“ without separating wall	05102	75
Lunch box „Bamboo“, small	01536	90	Storage box „Universal box“	05238	83
Storage box „Banana box 2.0“	05036	82	Lunch box „Universal box“ large	05302	83
Lunch box „Beech“	01859	70-71	Lunch box „Vesper“, large	01418	90
Lunch box „Break“	05230	74	Lunchbox „Vesper“	01224	90
Storage box „Bread box“	05248	83	Divider „Triangle“	05150	135
Storage box „Brunch box“	05242	76	Safety vest „Kids“	09053	289
Lunch To Go	05269	80	Safety vest „Standard“ 5-part set in case	09060	288
Lunch box „Cube“ deluxe	05299	73	Safety vest „Standard“ case	09404	288
Lunch box „Cube“ deluxe, with compartment divider	05301	73	Safety vest „Standard“ poly bag	09004	288
Lunch box „Dinner box“	05245	75	Safety vest set „Compact“	09994	289
Lunch box „Dinner Box Plus“	05025	75	Waterball „Football“, small	07430	260
Storage container „Double“ 19x13.5x8.5 cm	01648	89	Water Polo ball „Midi“ transparent	08070	260
Storage box „Flat box“	05231	76	Spirit level „Misura“ 30 cm	01397	246
Lunch box „Foodbox“	05632	77	Santa Christmas Hat	08641	324
Storage box „Fresh box“	05250	80	Wine carry bag „Avignon“	08689	303
Storage Box „Kiwi-Box“	08827	82	Wellness-Ball „Hedgehog“	06230	202
Lunch box „Lunch box“	05243	74	Chain of pennants „Germany“	07188	238
Storage box „Lunch-Box“ to paint on	05283	74	Flying disc „Elastic Flyer“	01331	257
Lunch box „Match“	04568	70	Flying disc „Heli 30“	01341	258
Lunch box „Metallic“	08457	86	Flying disc „Mini 10“	01300	257
Storage box „Mini box“	05237	80	Flying disc „Professional 23“	01323	257
Storage box „Multi box“	05235	79	Flying disc „Ring 25“	01340	258
Storage box „Orange Box“	05032	82	Flying disc „Space Flyer 18“	01315	256
Lunch box „Break box“	05244	74	Flying disc „Space Flyer 21“	01327	256
Lunch box „Picnic“	05253	76	Flying disc „Space Flyer 22“	01321	256
Lunch box „Quadrado“, large	01381	88	Flying disc „Space Flyer 22“, upcycling	01758	256
Lunch box „Quadrado“, small	01382	88	Flying disc „Space Flyer 24“	01316	256
Storage box „School box“ junior	05268	73	Flying disc „Space Flyer 26“	01317	256
Lunch box „School Box“ deluxe, bear version	05298	73	Flying disc „Super Flyer Maxi 30“	01350	258
Lunch box „School Box“ deluxe, with compartment	05297	72	Flying disc „Ufo 22“	01328	257
Lunch box „School Box“ deluxe, without separating	05296	72	Throwing game „Mini pinball 50“	01185	257
Lunch box „School box“ large	05236	71	Laundry bag „Jumbo“	01770	315
Lunch box „School Box“ large with separating bowl	01032	71	Laundry net „PEARL“, large	01234	315
Storage box „School box“ middle	05282	72	Laundry net „PEARL“, small	01236	315
Storage Box „School Box“ medium with separator	05276	72	Dice cup „Combi“ with 5 dice	03230	269
Storage box „Slim box“	05241	79	Dice game „The big throw“ in case	03226	269
Storage box „Snack box“	05247	76	Dice game „The big throw“ in plastic box	03227	269
Lunch box „Switch“	05389	78	Toothbrush tumbler „Clean“	05226	200
Storage box „Take it“	01270	81	Toothbrush tumbler „Fresh“	05277	200
Lunch box „Twin Box“ with separating wall	05104	75	Toothbrush tumbler „Pure“	05225	200

Index.

Item	Item No.	Page
Tick card	04317	198
Desk organiser „Pen holder“	04280	166
Note Box „Cube“	04285	166
Carpenter's pencil „Deluxe“	01014	146
Ruler „Craft“ 2m	01422	245
Ruler „Craft“ 2m colour	01426	245
Folding ruler „Dimension“ 1 m	06427	245
Folding ruler „Dimension“ 2 m	06316	245
Top hat Cavalier large	05113	133

Guidelines & Regulations.



Toys.

All offered children's toys comply with the European Directive 2009/48/EC on the safety of toys and the EN 71 series of standards. Toys may be unsuitable or dangerous for children of a certain age due to their function, dimensions, features, characteristics or other reasons. To further improve safety, the toy comes with warnings informing the consumer of the potential danger posed by the toy.

The following are the warnings that apply to the individual articles. Next to the offered items in this catalogue are small numbers that match the listed warnings.

1. Attention! Not suitable for children under 3 years, because of small parts that can be swallowed.
Choking hazard!
2. Attention! Not suitable for children under 3 years.
Risk of injury due to long cord.
3. Attention! Not suitable for children under 3 years.
4. Danger of strangulation and tripping due to long cord.
Do not use near power lines or during thunderstorms.
5. Attention! Use under the direct supervision of adults.
Not suitable for children under 3 years. Danger of falling! The Schneeflitzy requires great skill in steering and braking, so learn to use it on flat, safe terrain.
Use only by one person at a time.
6. Attention! Use only in shallow water under adult supervision. This is not a buoyancy aid!
No protection against drowning!
7. Attention! Do not aim at eyes or face.
8. Attention! Use under the direct supervision of adults.
Liquid can be swallowed!
9. Attention! Sharpener contains a sharp edge due to its function. Risk of injury!
10. Attention! Not for transporting children!

0+ to 8+

All information with „+“ is to be understood as an age recommendation or as an educational note.

Sporting items, fan items, decorative items.

The sports, fan and decorative items offered in this catalogue are sold as such. In order to prevent possible confusion with toys, these items are marked with the following inscription.

Sport „Sporting goods - Not toys!“

Fan „Fan items - Not a toy!“

Deco „Decorative items - Not a toy!“

REACH.

All offered articles comply with the European Regulation No. 1907/2006, Registration, Evaluation, Authorisation and Restriction of Chemicals. The EU's objective is to produce and use chemicals in such a way as to minimise adverse effects on human health and the environment.

Customer information.

We hereby confirm, in accordance with Article 59 (1, 10) of the EC- Regulation number 1907 / 2006 (REACH), that articles delivered by us do not contain substances of the candidate list above 0.1% mass. We undertake to regularly compare our products with the substances specified in the candidate list in accordance with the REACH Regulation. Insofar as we determine that our products comply with Art. 33, we will inform you about this immediately and take appropriate measures in individual cases.

General information.

Please understand that we do not have the items in stock in all colours of our standard colour palette. Ask our sales staff for the available colours, minimum quantities and colour surcharges. We print exclusively with physiologically harmless inks. The disposal of the paints and screens is carried out in a closed system. Screens are recycled after use for technical reasons. For repeat orders, the sieve must be recreated and calculated.

For imprints, we need a copyable black-and-white original or a film 1:1, with transfer motifs reversed. In the event of necessary changes to your originals or multi-colour films, we will charge you the lithographic costs incurred by us. However, we will inform you in advance and make the changes only with your permission. It is also possible to create individual designs and final drawings on request. These will be invoiced by us at cost. An exact reproduction of the desired shade depends on the colour and condition of the item. For darker surfaces, white may be required.

Deliveries to new customers and abroad are made against prepayment or cash on delivery or irrevocable letter of credit.

The contractual relationship shall be governed exclusively by the laws of the Federal Republic of Germany. The UN Convention on the International Sale of Goods (CISG) and the referral provisions of German Private International Law (IPR) do not apply.

Errors and misprints excepted.

Current Situation.

Significant global constraints and delays remain in global supply chains. In addition, there is a shortage of freight rates from Asia to Europe. These circumstances are beyond our control and we have no control over them. Despite the best possible planning and constant communication with our suppliers and freight forwarders, delivery delays and price adjustments due to increased procurement costs unfortunately may continue indefinitely. Should this be the case, we reserve the right to adjust the prices and/or delivery dates mentioned in the catalogue accordingly. Unfortunately, this cannot currently be avoided and we ask for your understanding.



PROMOTION FOR LIFE

elasto GmbH & Co. KG
Franz-Sollfrank-Str. 6
D-92237 Sulzbach-Rosenberg

T +49 9661 890 0
info@elasto.de
elasto.de/en



All of our offers, deliveries and services are made exclusively on the basis of our terms and conditions of delivery and payment (GTC).
You can find our complete GTC at elasto.de/en/conditions-of-use